

4x3+2+2 | 50 | 2013

4x3+2+Z / 50 / 2013

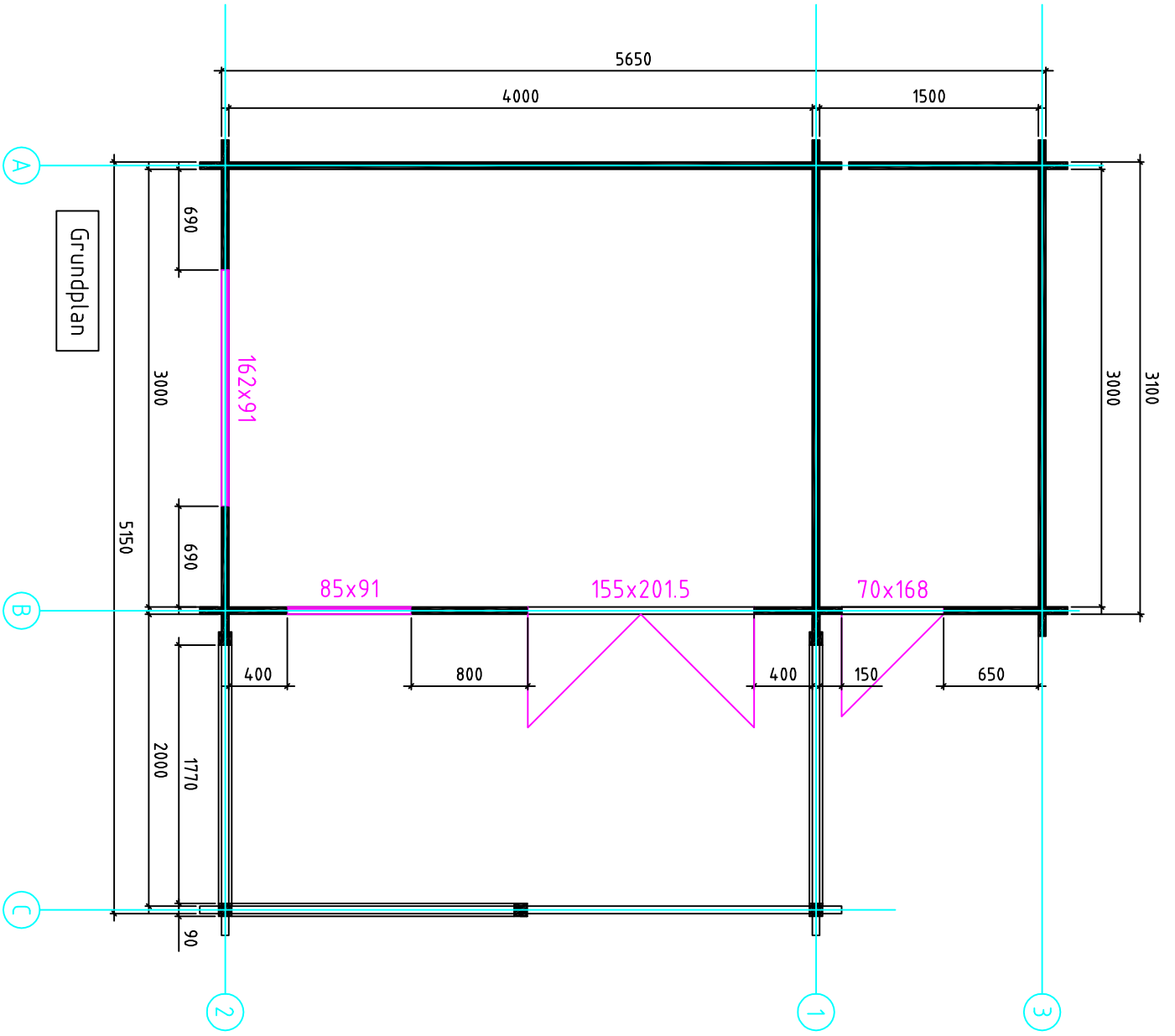

Wand 1 ↗

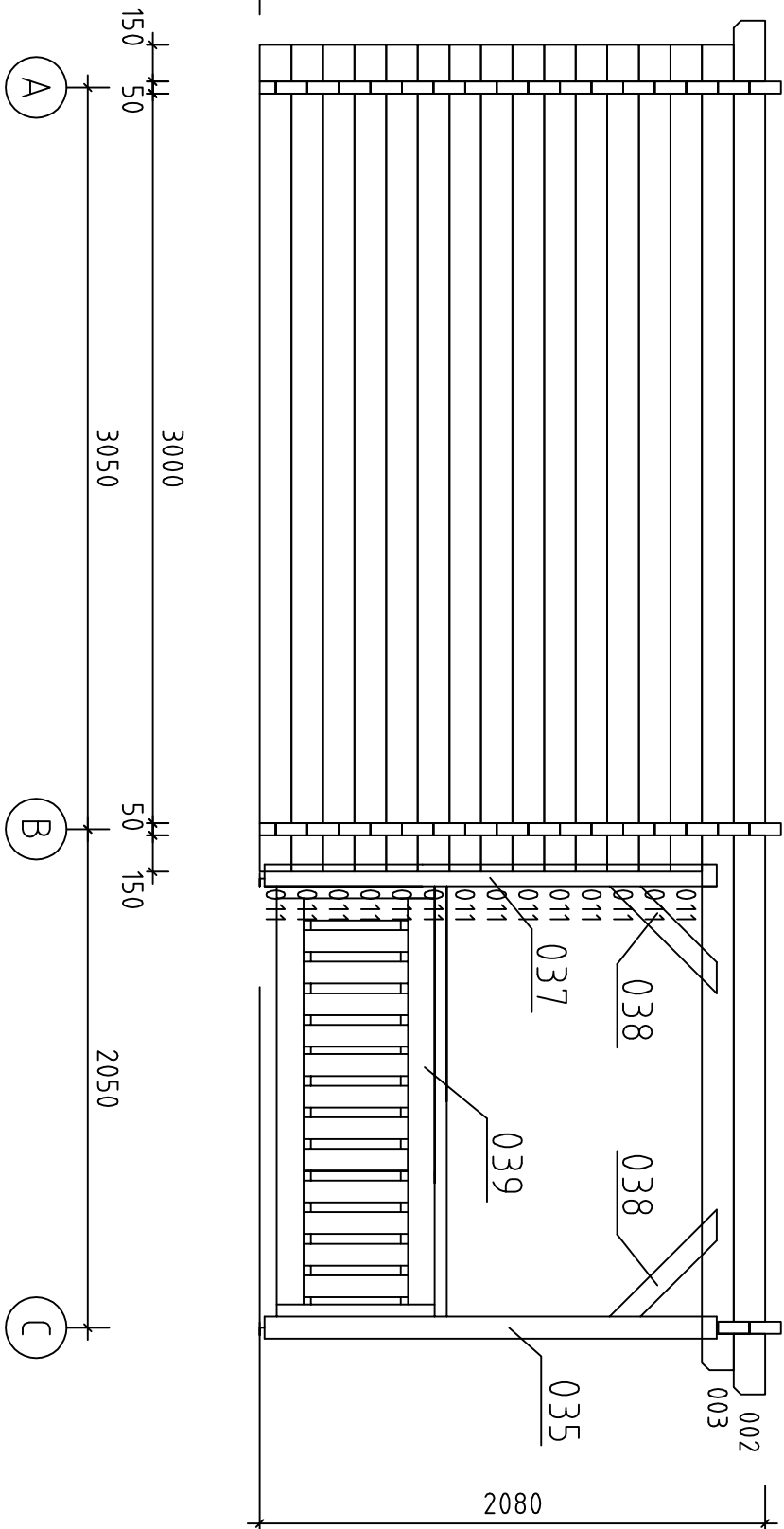

4X3+2+Z / 50 / 2013

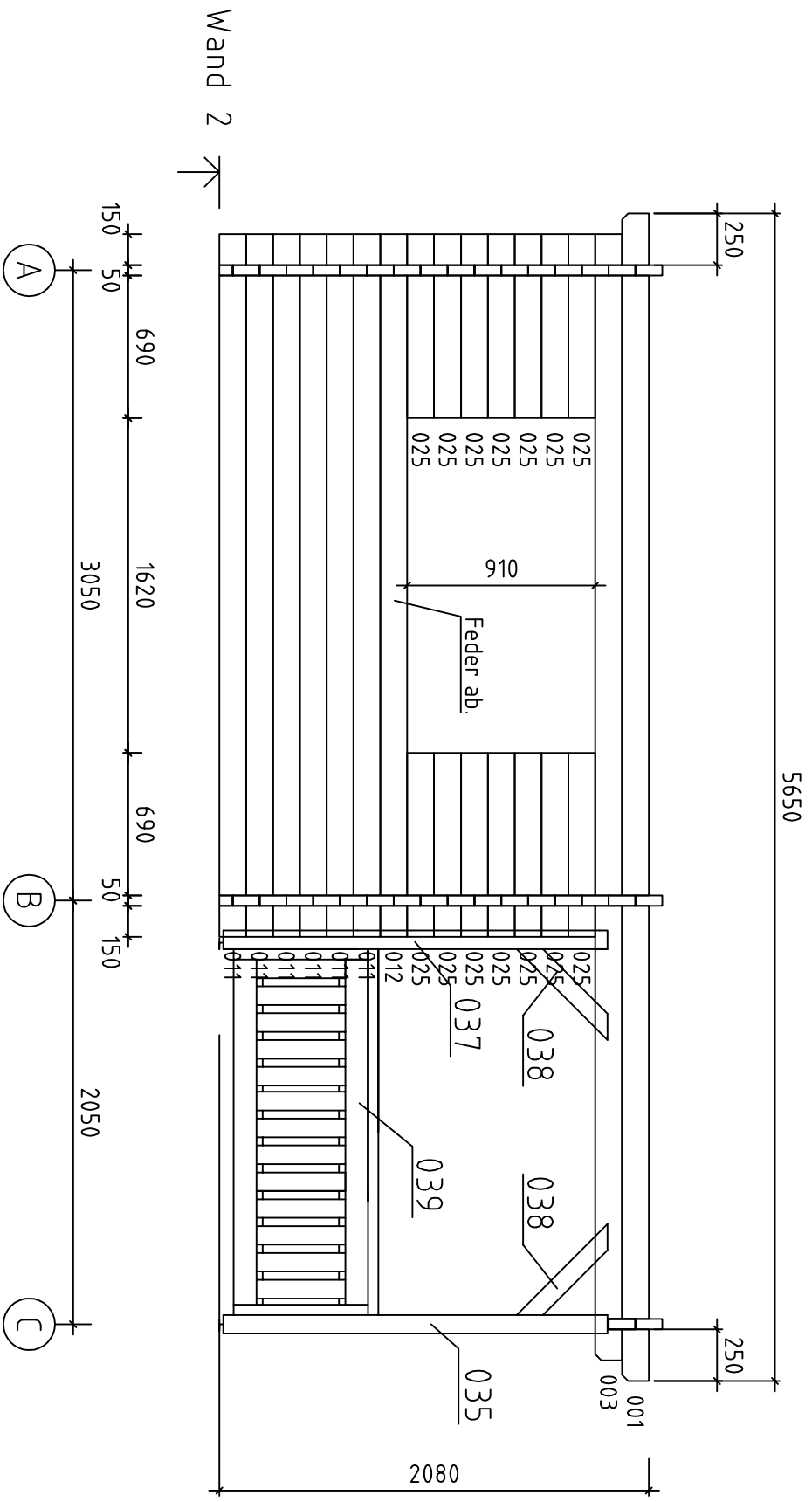

4X3+2+Z / 50 / 2013

Wand 3

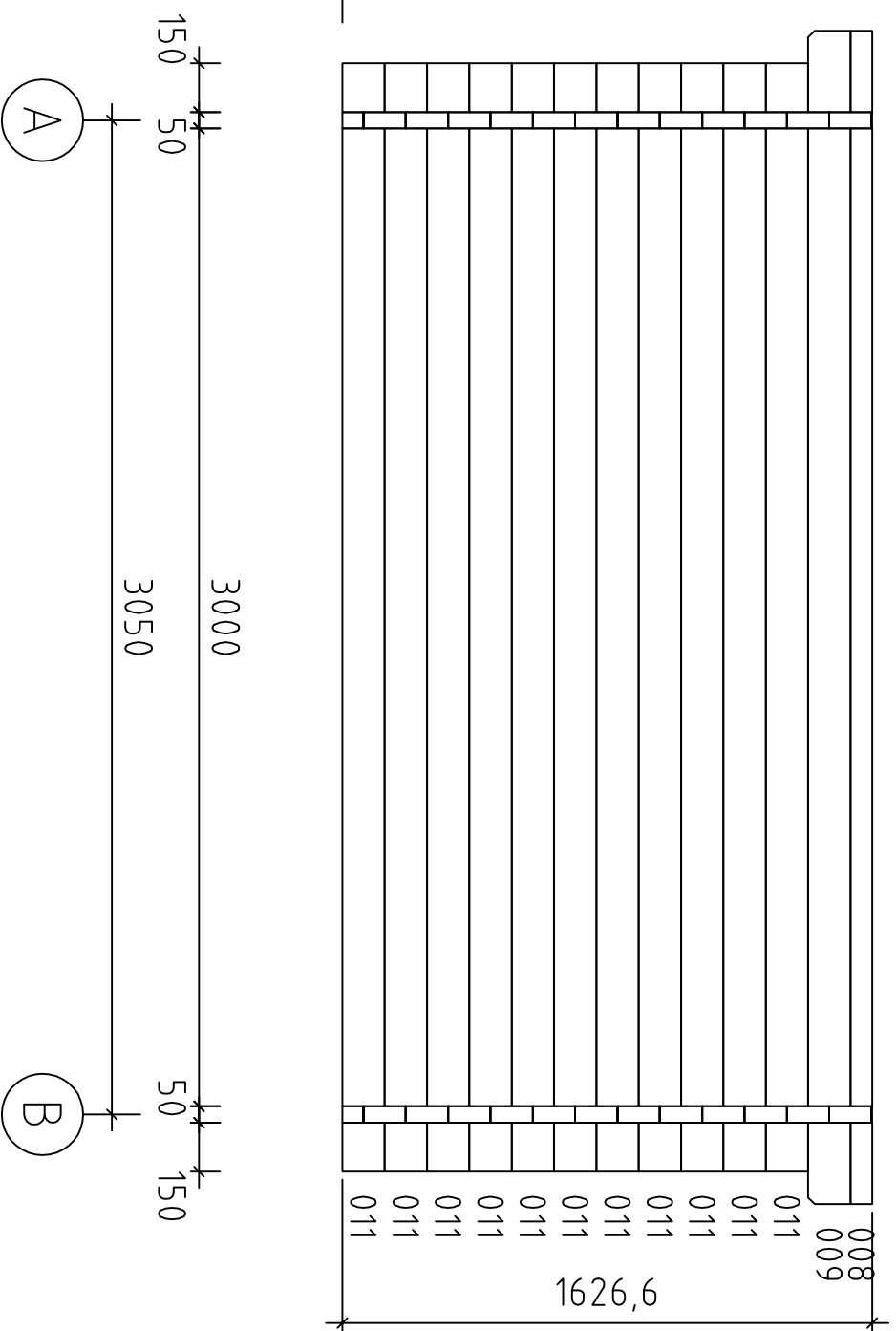

4x3+2+Z / 50 / 2013

Wand A

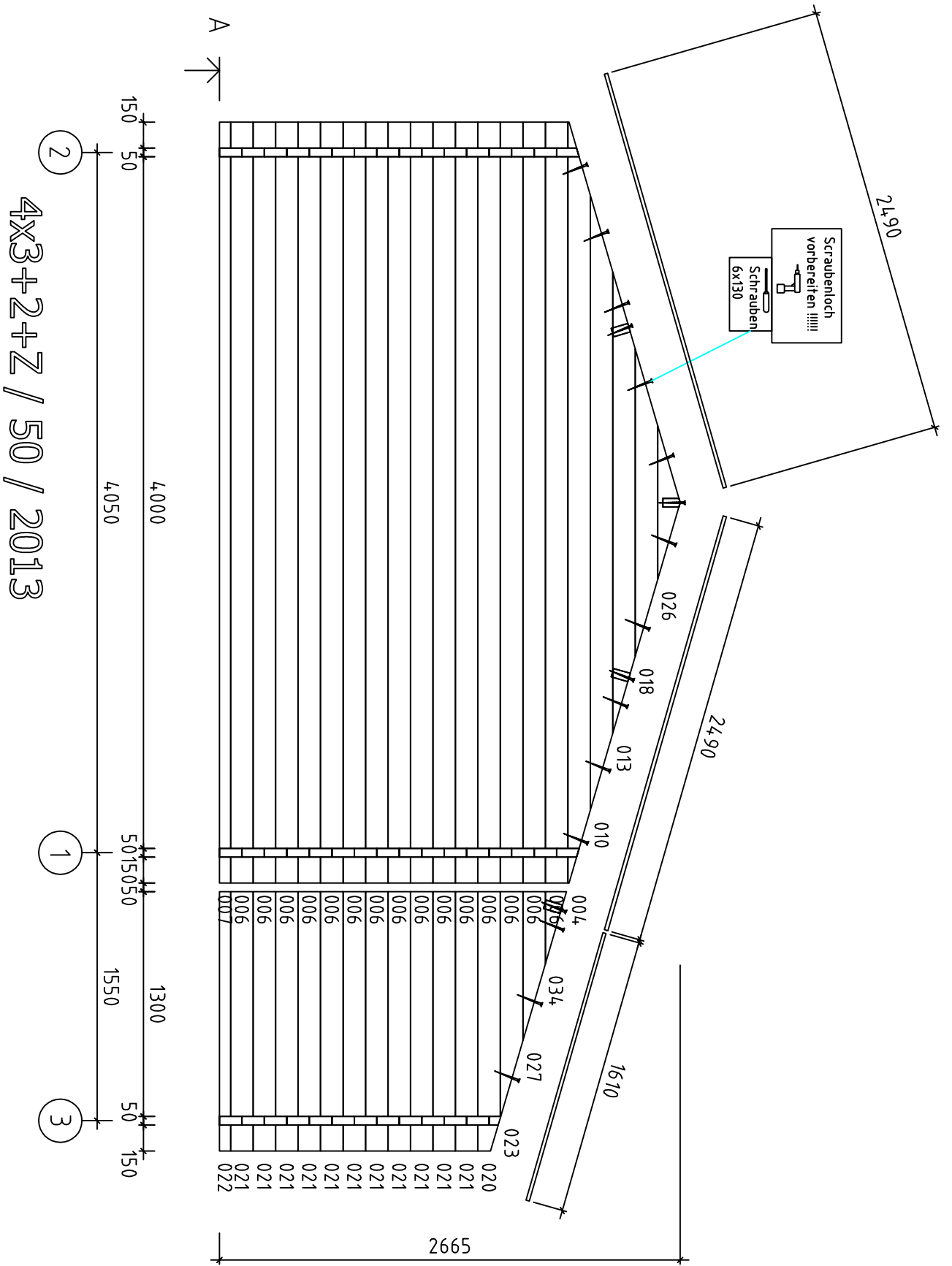



Wand C ↗

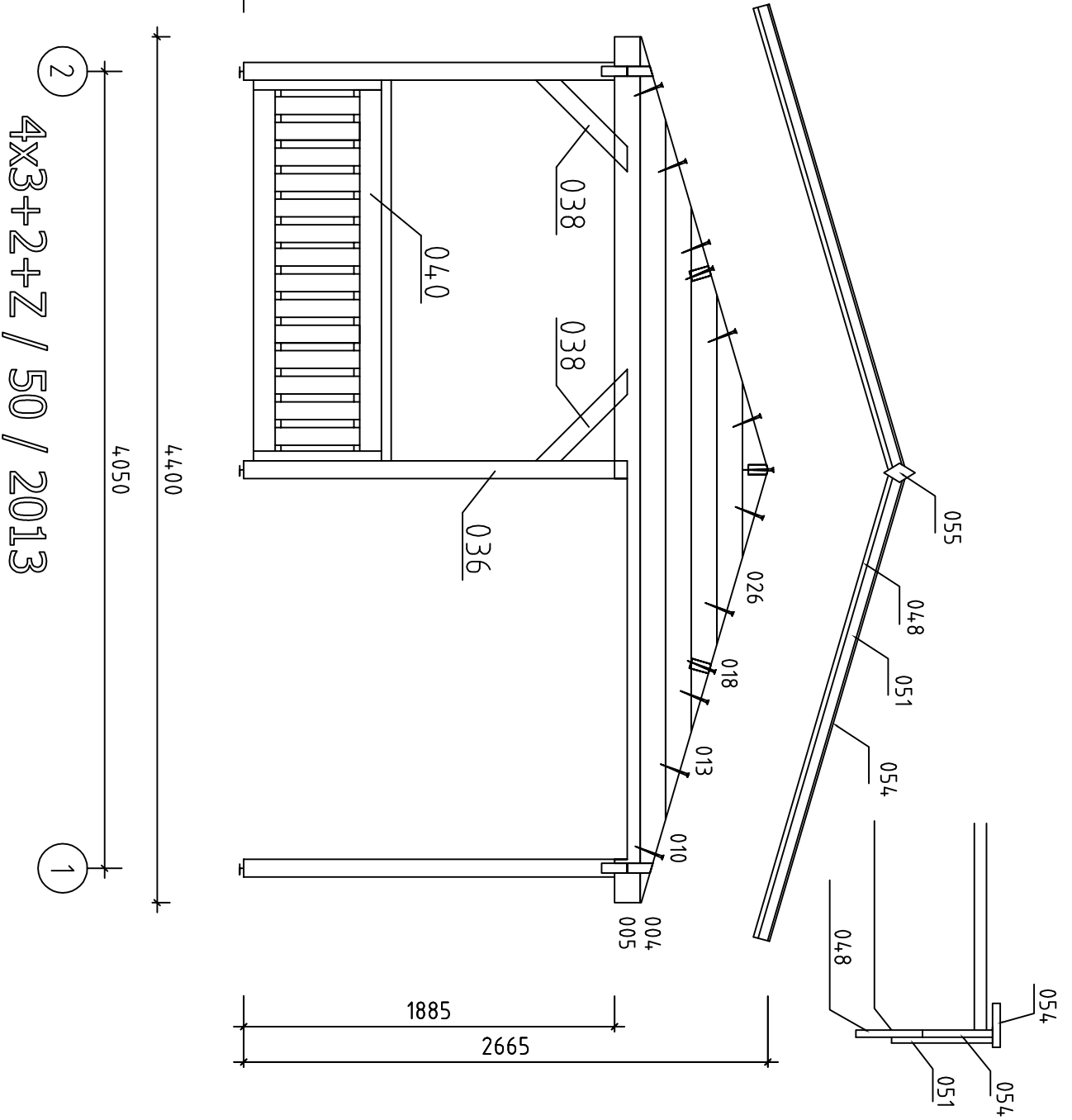







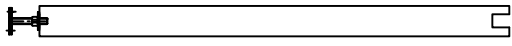
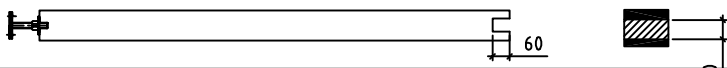
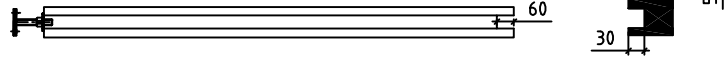
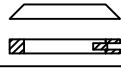

Pos	4x3+2+Z / 50 / 2013	ST	F (mm)	L (mm)
001		1	50x130	5650
002		1	50x130	5650
003		2	50x130	5450
004		3	50x130	4400
005		1	50x130	4400
006		15	50x130	4400
007		1	50x65	4400
008		1	50x67	3600
009		1	50x130	3600
010		3	50x130	3556
011		31	50x130	3400
012	Feder ab	1	50x130	3400
013		3	50x130	2667
014		1	50x65	2250
015		7	50x130	2250
016		1	50x130	2250
017		1	50x130	2250
018		3	50x130	1778
019		1	50x65	1550
020		1	50x130	1500
021		11	50x130	1500
022		1	50x65	1500
023		1	50x130	1300
024		1	50x130	1300
025		14	50x130	890
Kood	Materjal	File	uustrükk.dwg	Leht 1/3

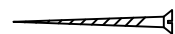

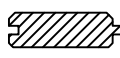
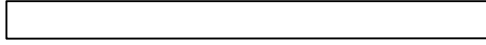
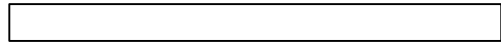
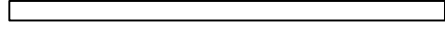
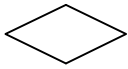

Pos	4x3+2+Z / 50 / 2013		ST	F (mm)	L (mm)
035	Pfosten Kolom		2	90x90	1820
036	Column		1	90x90	1880
037			2	90x90	1820
038	Träger		6	90x90	655
039	Barriere		2		1770
040			1		1935
041	Schrauben		36	5,0x80	
042	Schrauben		62	6,0x130	
044	Abdeckleiste Afdeklijst Finishinglist			40x20	12m
045	Dachbrettern Dakplanken Roofboard's		128	90x20	2490
046			41	90x20	1610
047	Giebelzierleiste Gevelsierlijst Frontlist		1	120x20	4300
048			3	120x20	2650
049			1	120x20	2200
050	Giebeldeckleiste Gevellijst Frontlist		1	90x20	4300
051			3	90x20	2650
052			1	90x20	2200
053	Giebelleiste Gevelanderlijst Frontlist		2	70x20	4300
054			6	70x20	2650
055			2	70x20	2200
056	Giebelsegment Gevelsegment Frontsegment		2		
057	Dachpappenleiste Dakshingleslijst Fillet of cardboard		8	40x20	2825
058	Adapter Koppelstuk Adapter		1		2150
059			1		400

# Doppeltür

Beschlag:

Türklinken mit der Lasche = 1 Kmp.

Schraubeh 5x80mm = 4 St.

Schnepper mit Schlüsseln = 1 Kmp.

Metalblechen (zwei St.) Pos. 5,  
befinden sich auf untere oder  
obene Türflügelkante.

Schrauben 5x80

①

Schrauben 5x80

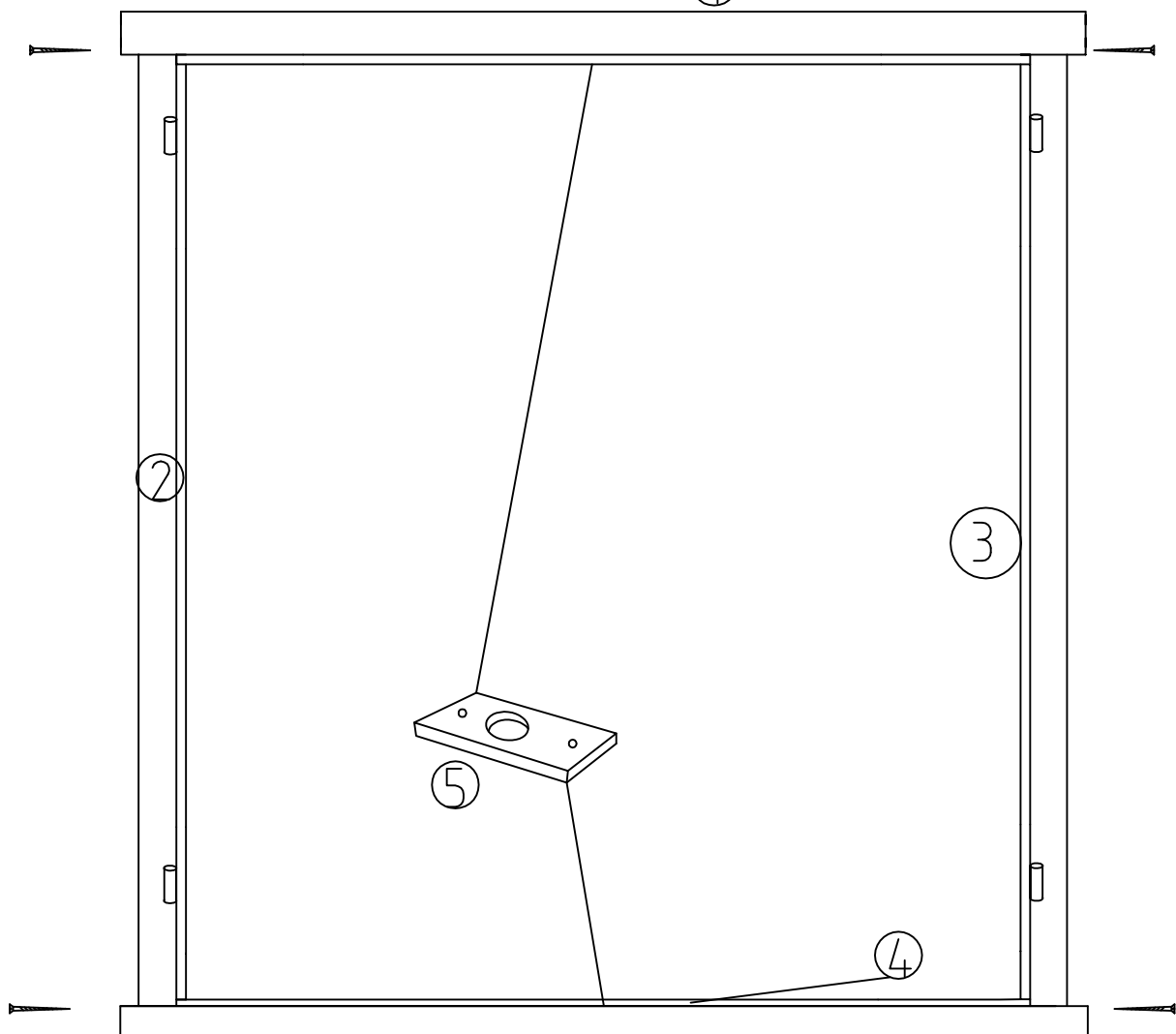

Schrauben 5x80

Schrauben 5x80

Wand 1

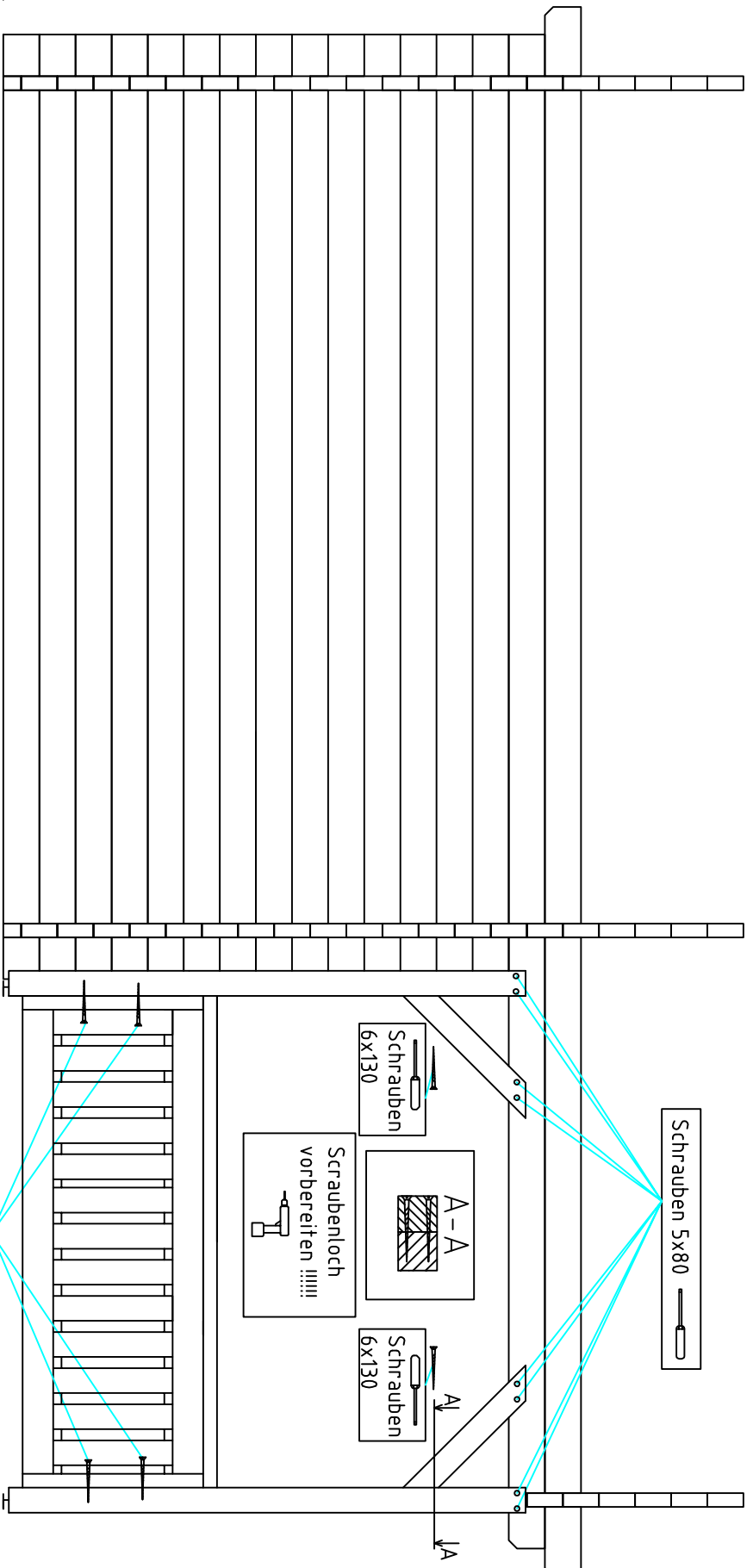

Schrauben 5x80

Schrauben 6x130

A - A  
Schaublenloch  
vorbereiten !!!!!

Schrauben 6x130

Schrauben 5x80

3050

2050

A

B

C

4x3+2+Z / 50 / 2013



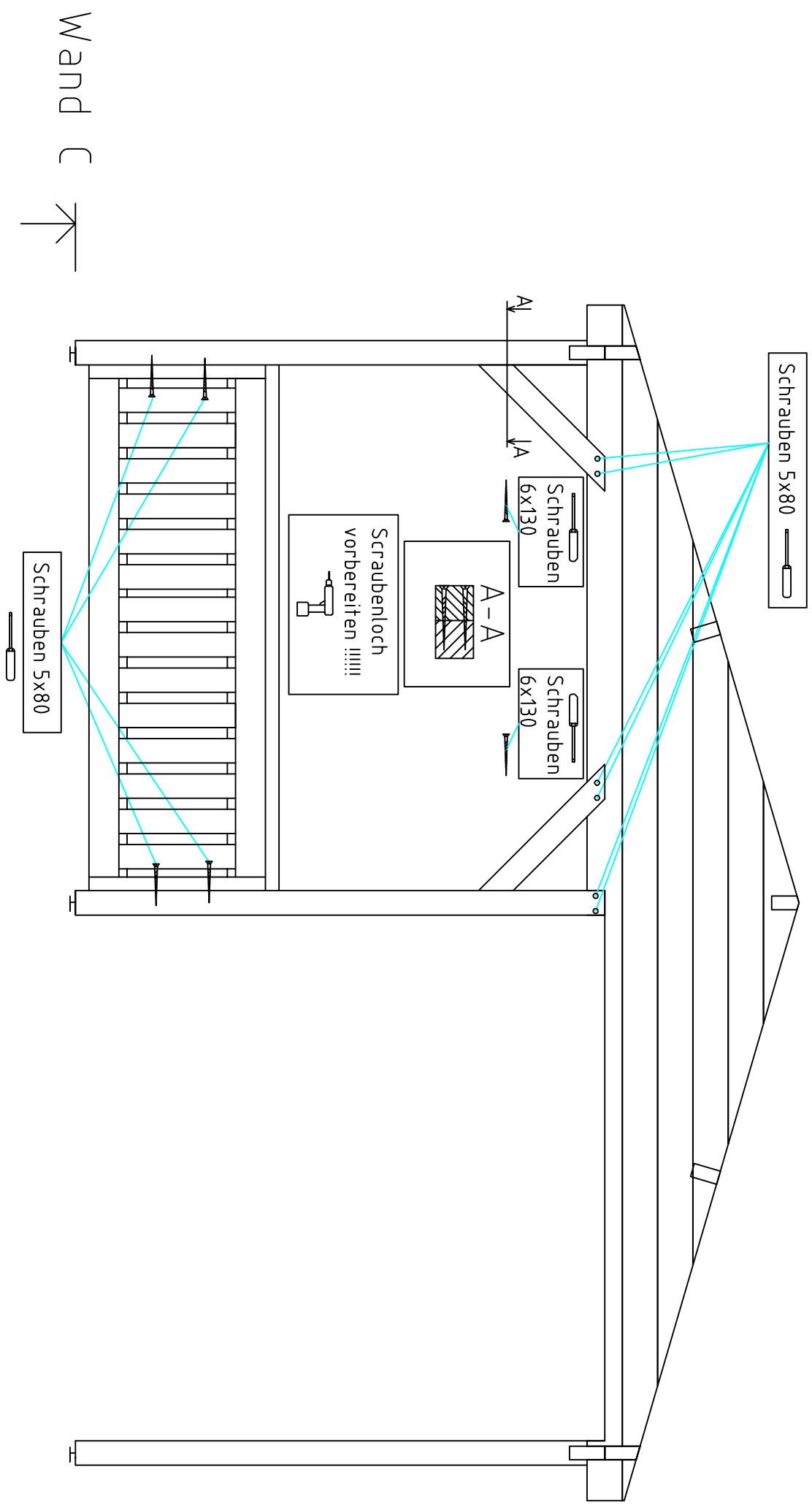

4050

2

4x3+2+Z / 50 / 2013

1