

Werder / 50 / 20

Werder / 50 / 20

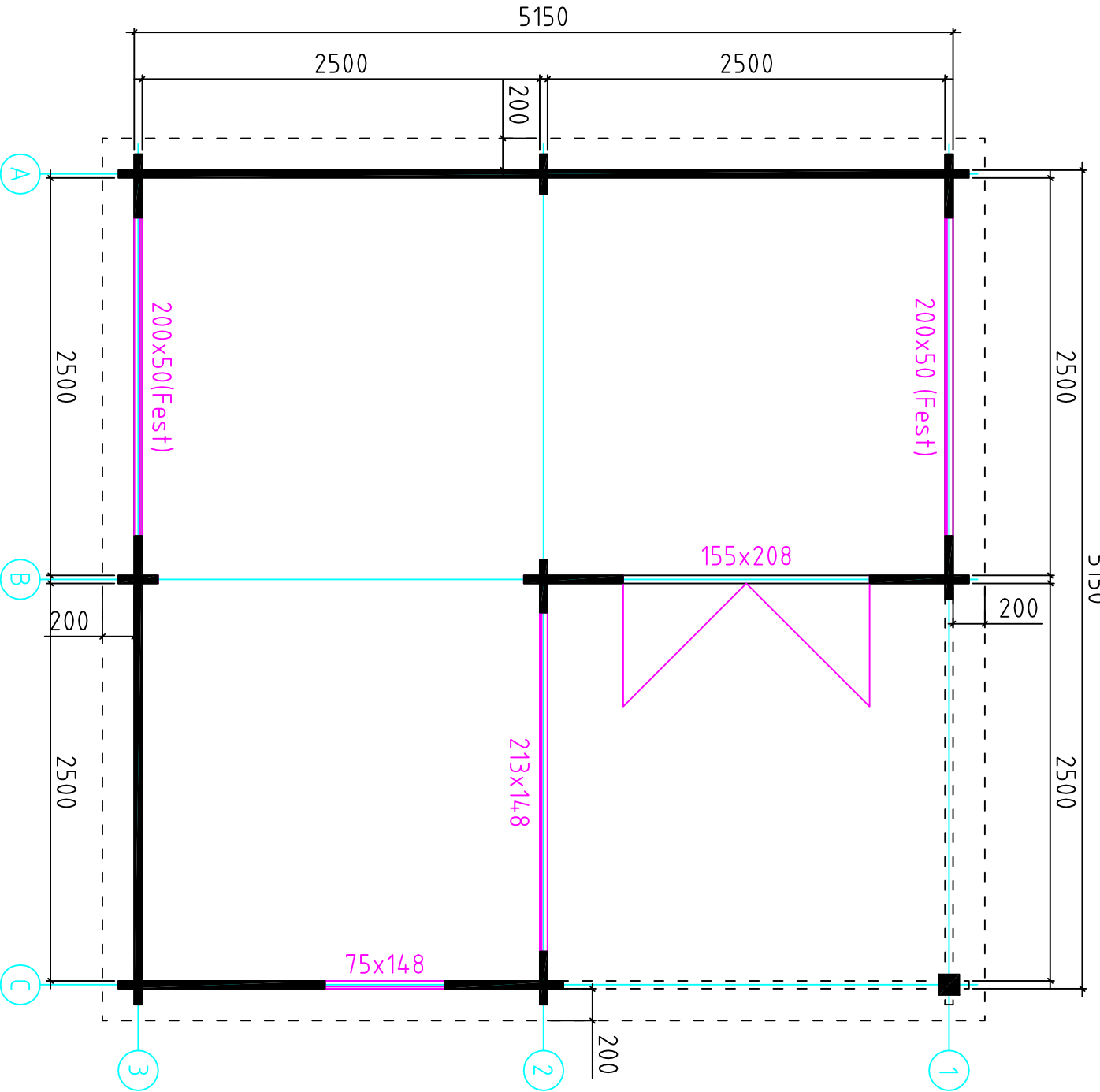

Werder / 50 / 20

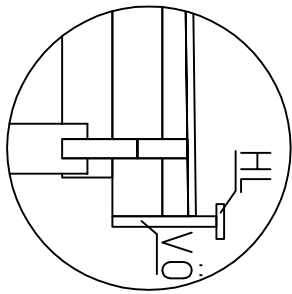
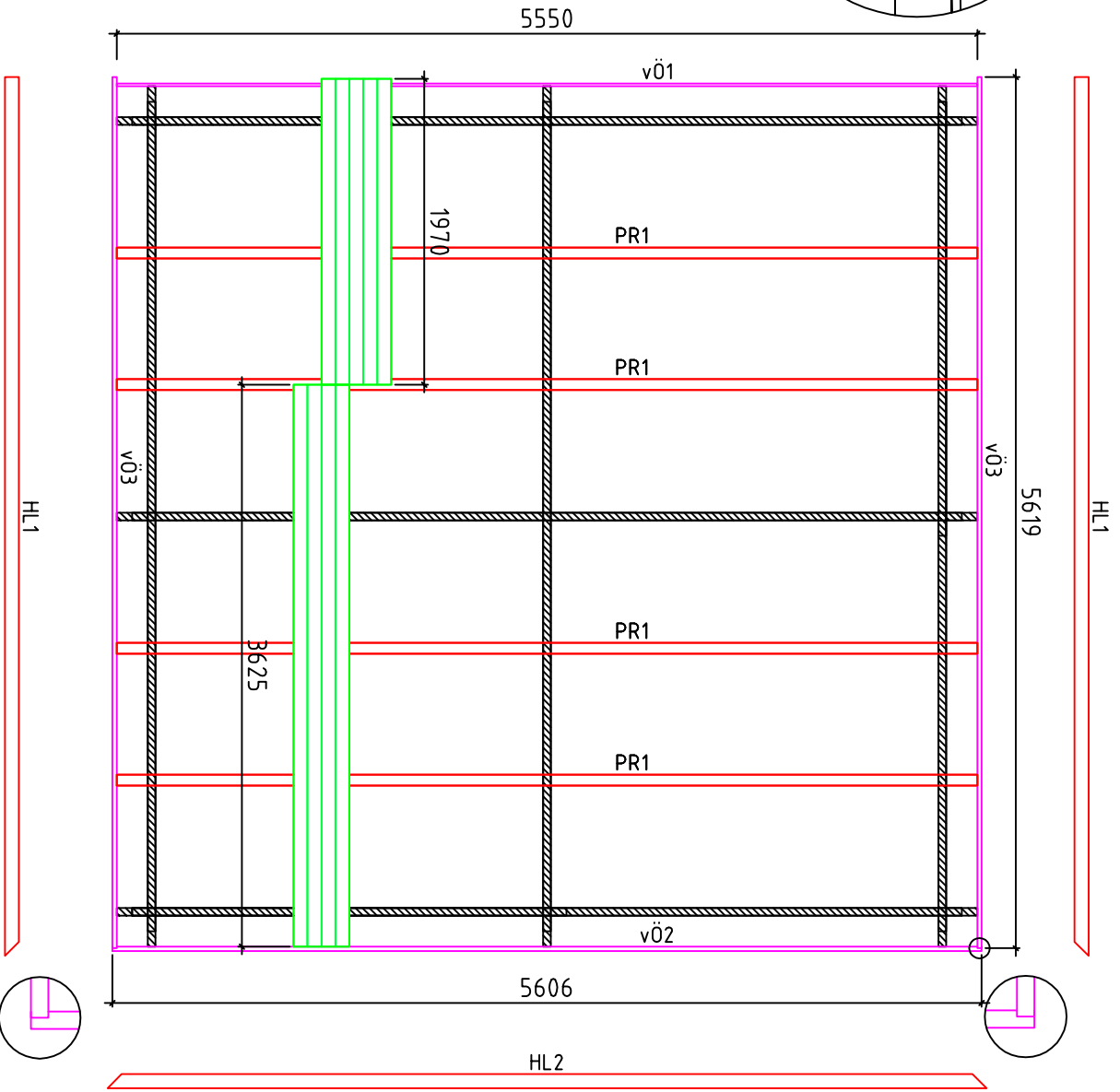
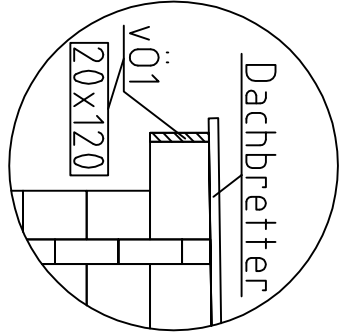

Dachbalken
Dachbretter
Elemente
Deckbretter

Wand 1 ↗

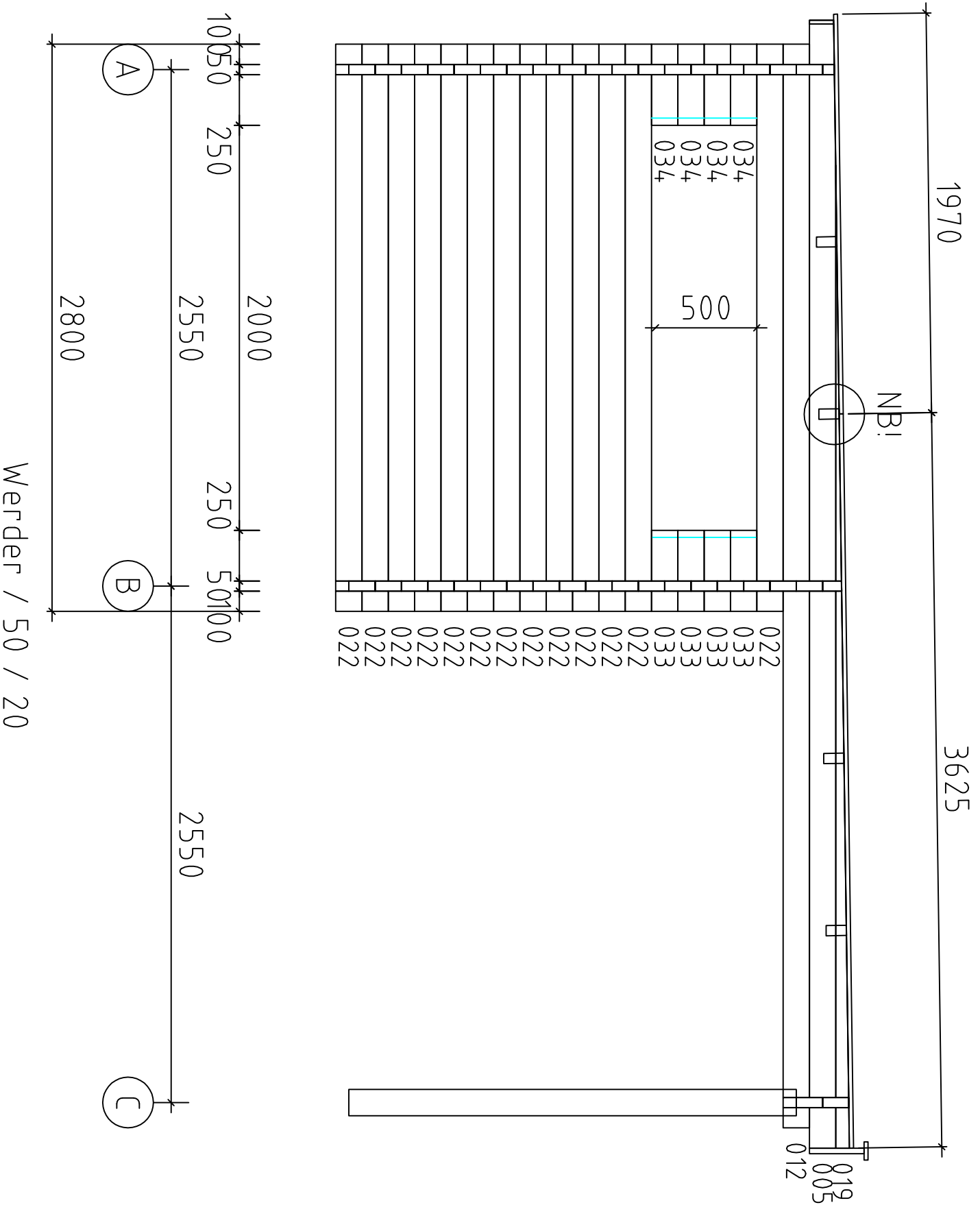

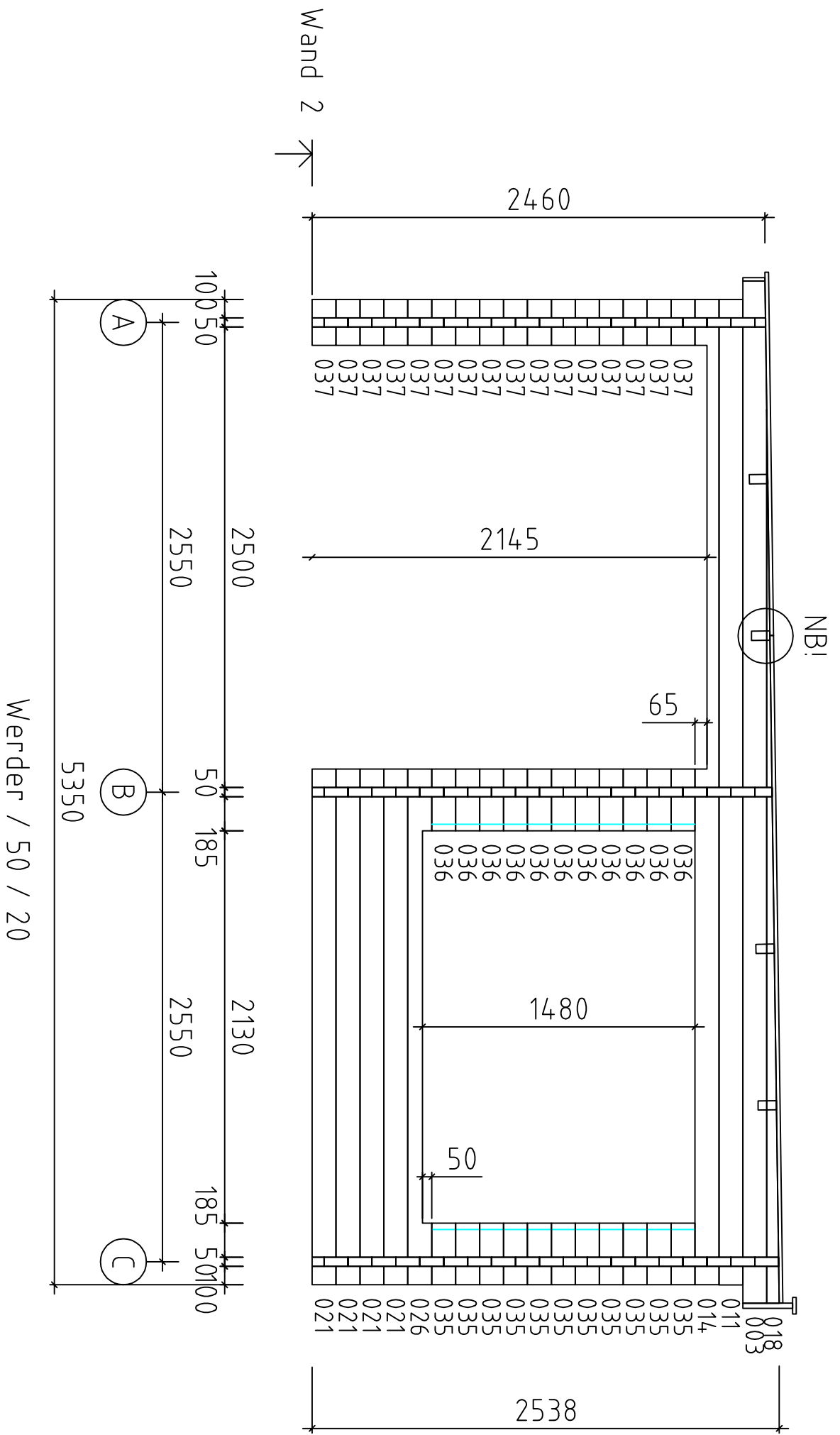

Wand 3 ↗

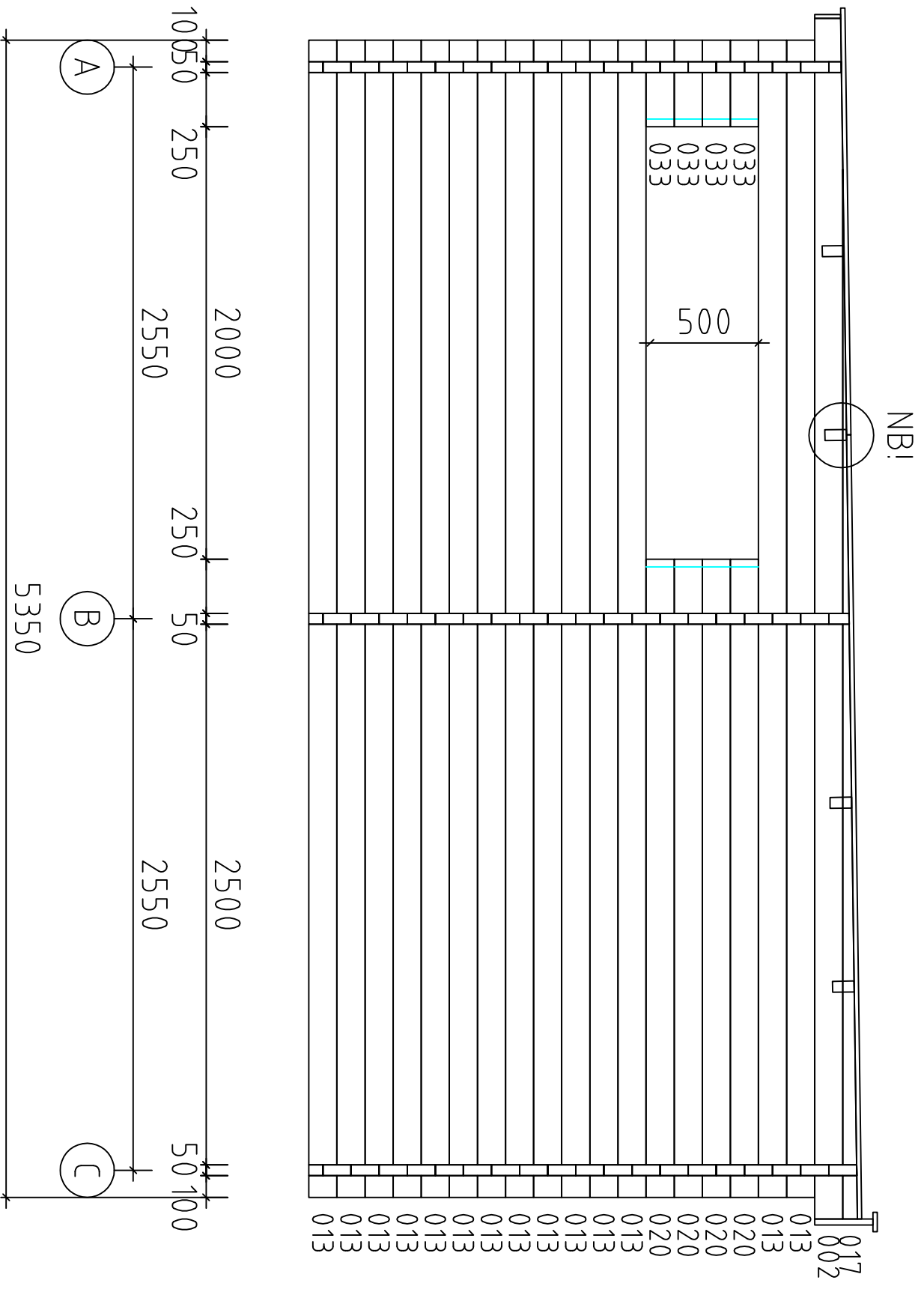

Wand A →



M8x90

3,5x50

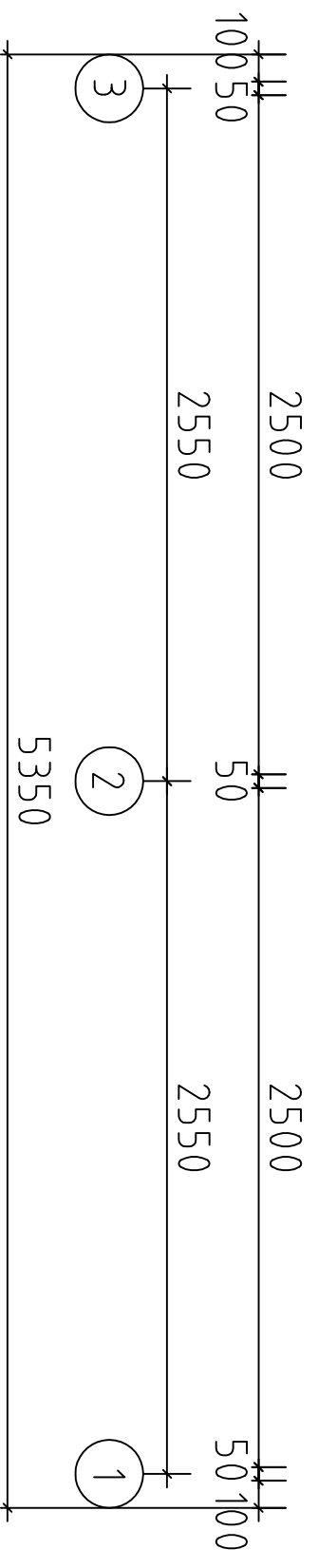
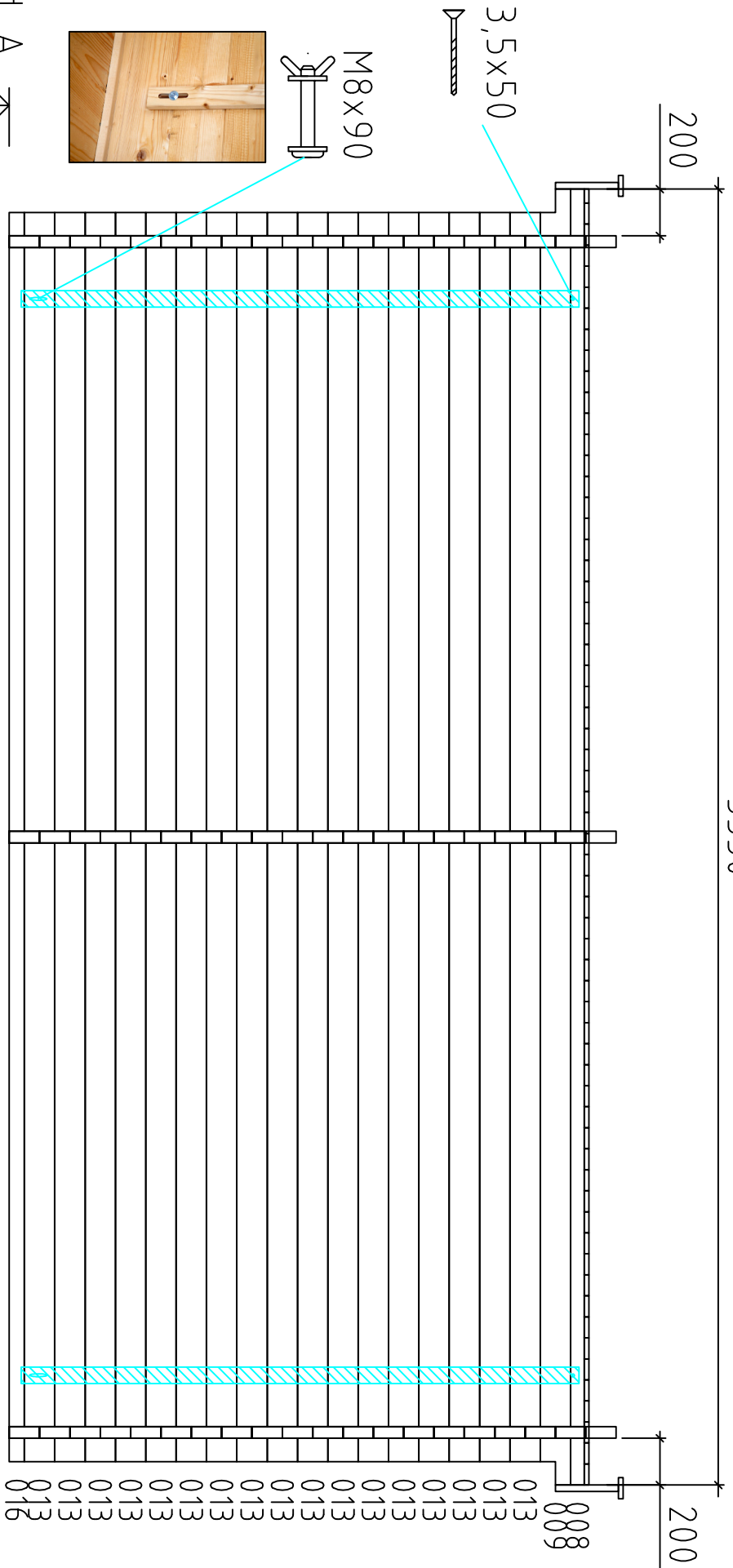

Werder / 50 / 20





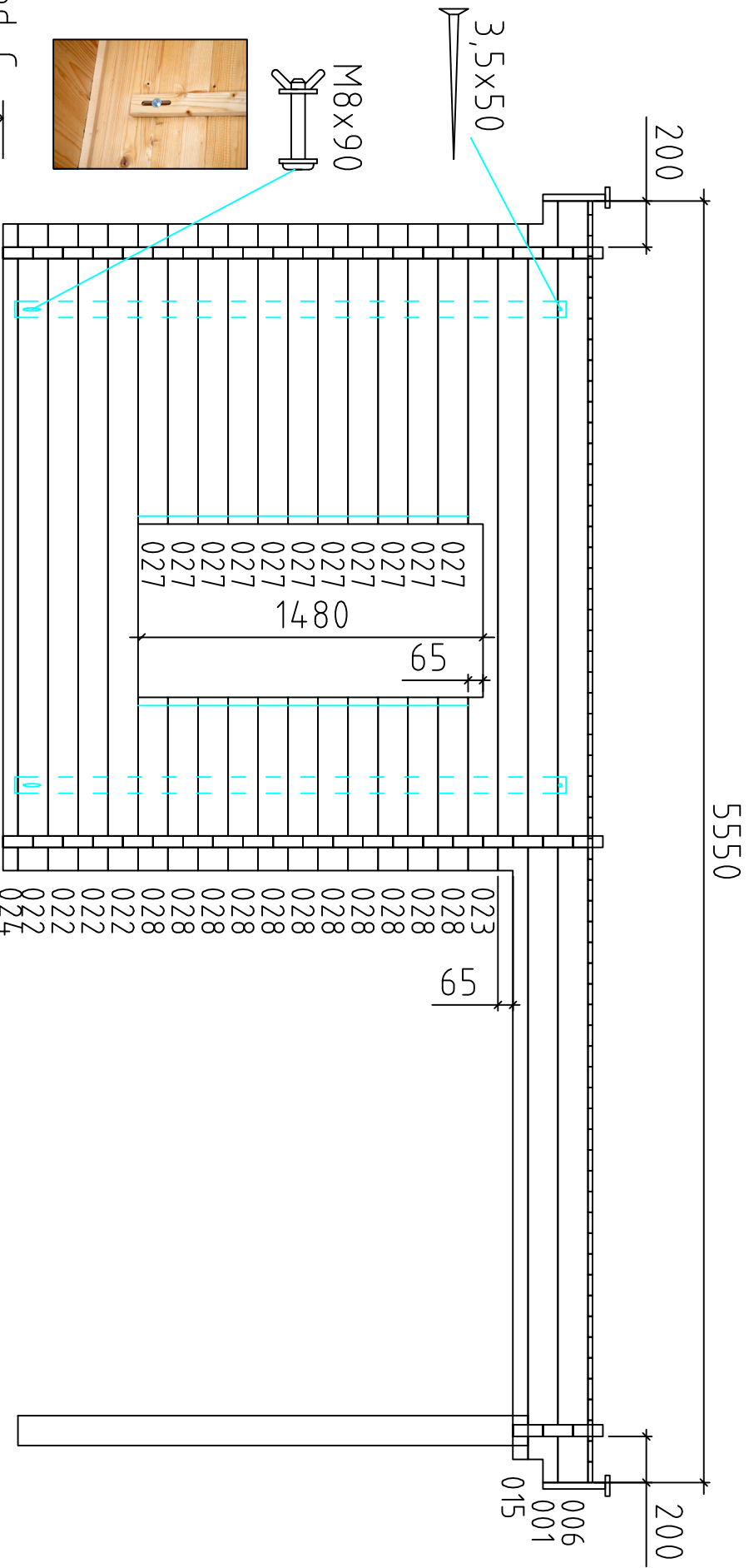

3

2

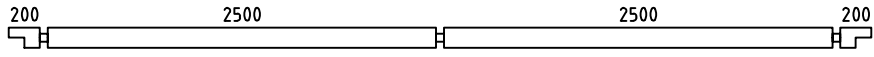
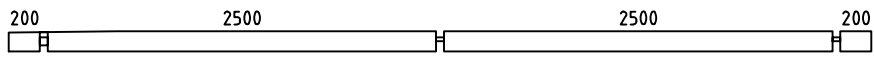
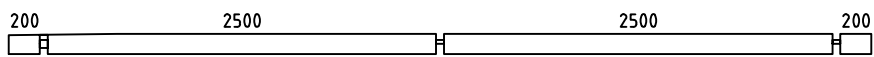
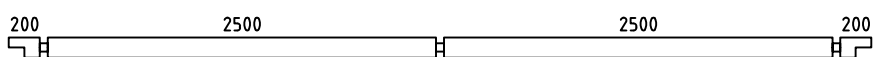
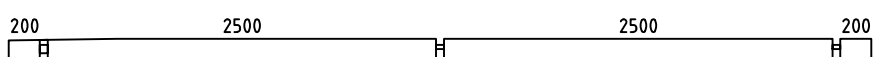
1

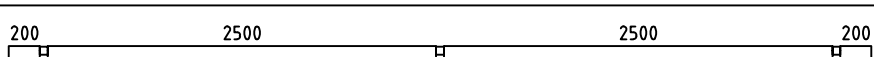

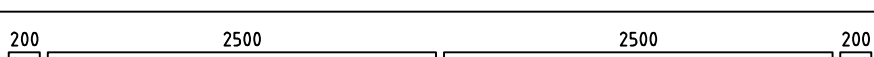
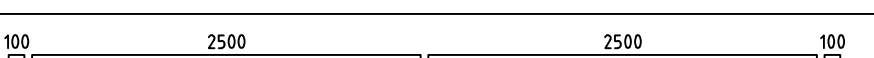
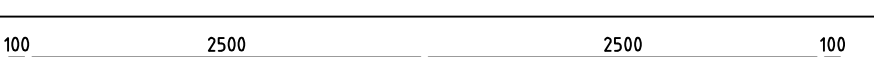
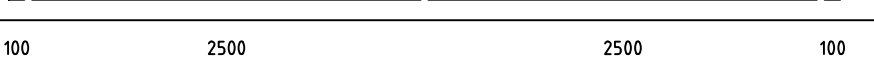
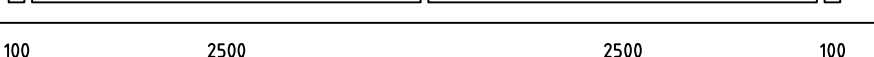
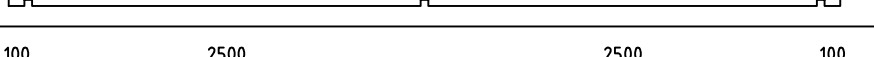
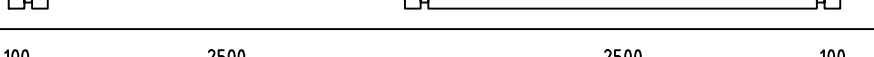
Werder / 50 / 20

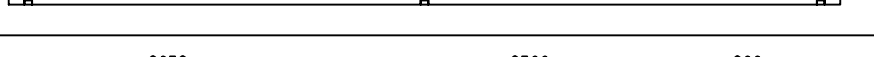
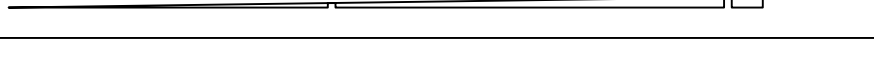
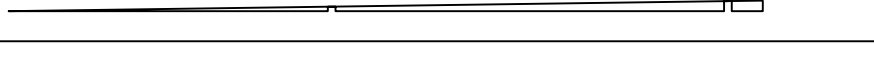
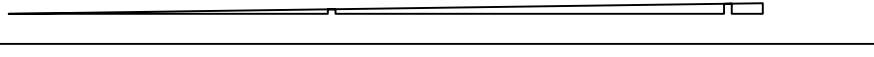
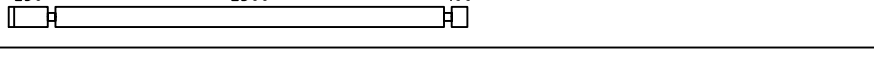
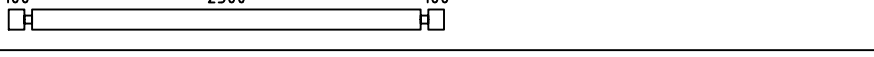
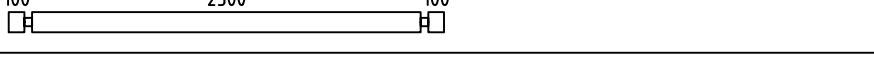
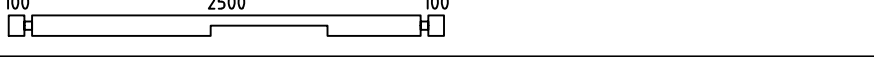
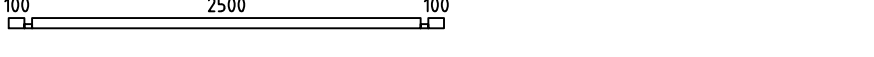
Pos	Werder / 50 / 20	ST	F (mm)	L (mm)
001		1	50x130	5550
002		1	50x130	5550
003		1	50x130	5550
004		1	50x130	5550
005		1	50x130	5550
006		1	50x130	5550
007		1	50x94	5550
008		1	50x59	5550
009		1	50x130	5550
010		1	50x130	5350
011		1	50x130	5350
012		1	50x130	5350
013		31	50x130	5350
014		1	50x130	5350
015		1	50x130	5350
016		1	50x65	5350
017		1	50x68	4853
018		1	50x68	4852
019		1	50x68	4852
020		4	50x130	2950
021		4	50x130	2800
022		17	50x130	2800
023		1	50x130	2800
024		1	50x65	2800
025		1	50x130	2800

Pos	Werder / 50 / 20		ST	F (mm)	L (mm)
vÖ3	Elemente		2	28x270	5619
vÖ2		-28 -28	1	28x270	5606
vÖ1	nur Brett		1	18x120	5550
HL2	Deckbretter		1	90x20	5668
HL1			2	90x20	5668
053	Dachbretter		62	90x20	3625
054			62	90x20	1970
055	Abdeckleiste			20x40	35m
056	Pfosten	kandid ümardatud	1	130x130	2210
Sturmleisten	Sturmleisten		4	70x20	2390
	Bolzen spez.		4	M8x90	
	Schrauben	Schrauben 3,5x50	4		
Fundament	 Schrauben 6x130	60			
Fussboden Dach	Schrauben 3,5x50	1200			
	Schrauben 4,2x55 (Terrassenschrauben)	200			
Montagematerial	Schrauben 6x130	60			
	Schrauben 3,5x50	120			
	Schrauben 5,0x80	120			

