

Kood	HELENE	Leht	1
Joonis	Plaan	Mootkava	1:50
Materjal	4,5 × 13,5	Kuup.	19.02.2019
Joonestas	File HELENE.dwg		

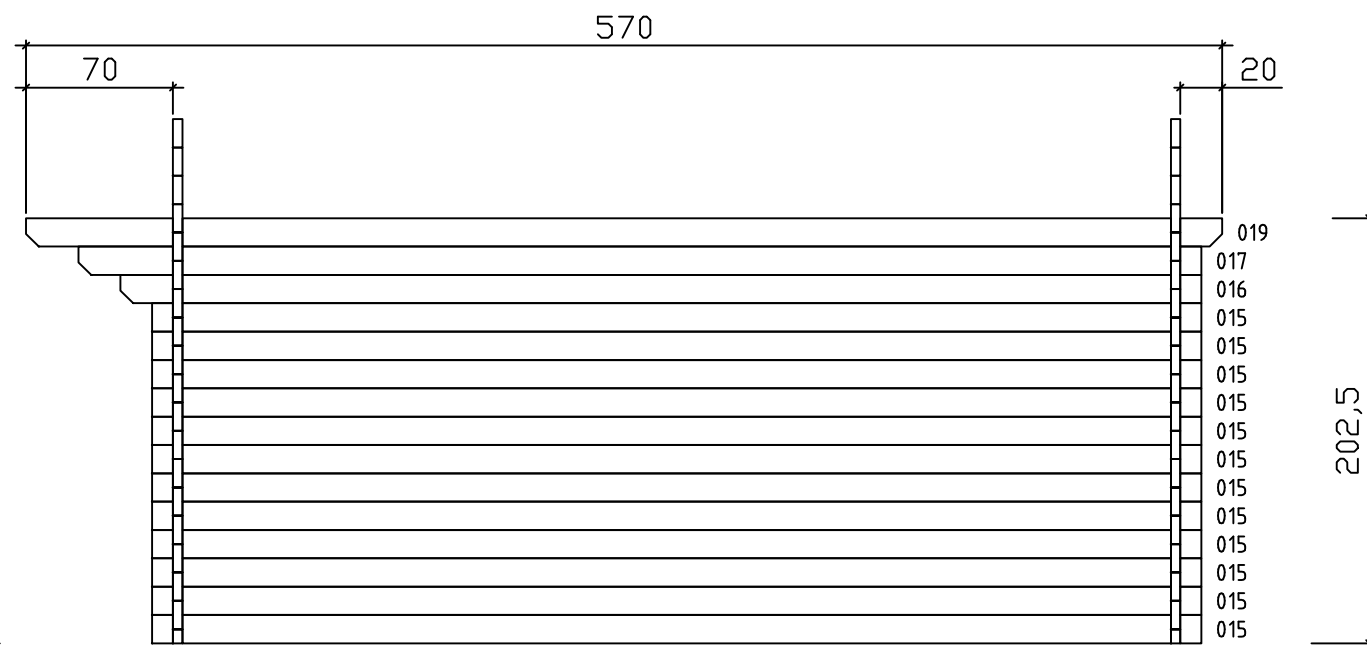

Wand B ↗

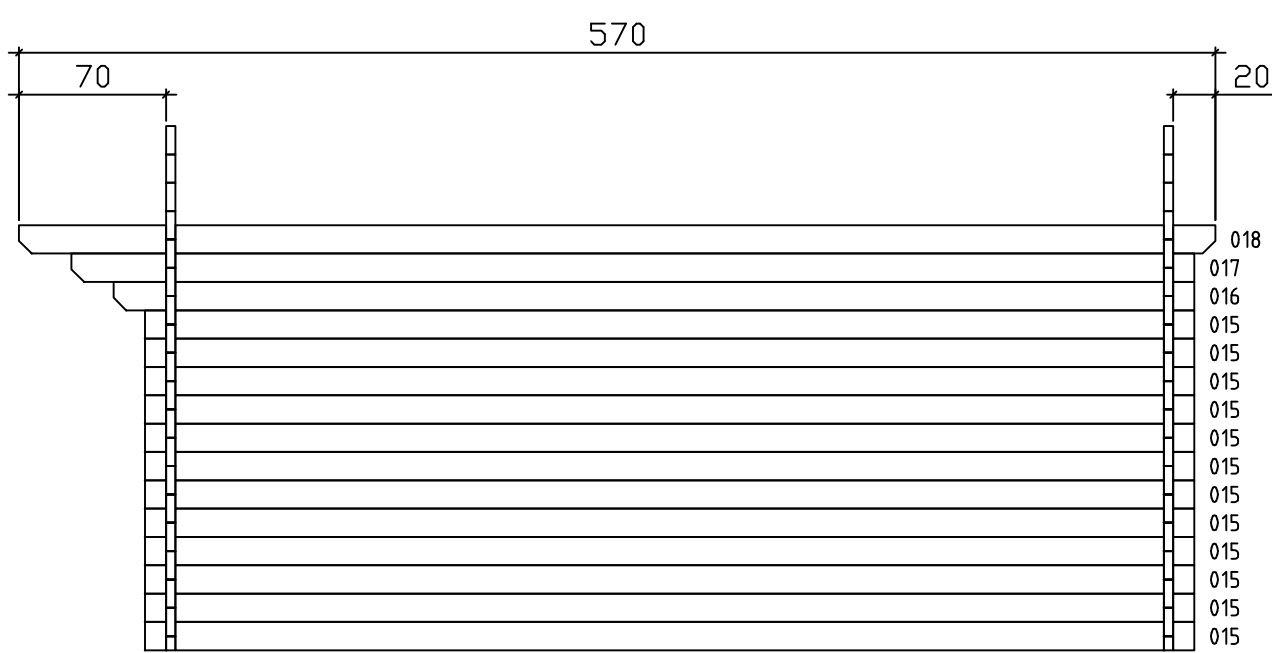
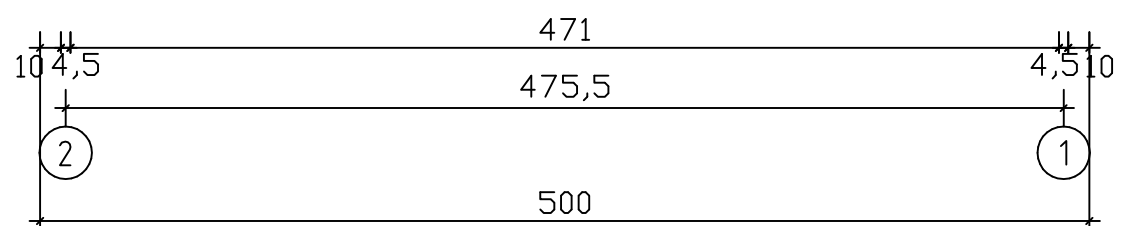

Wand A ↗

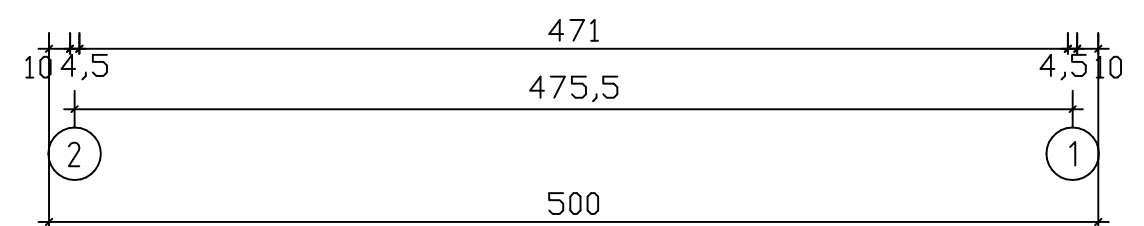

Kood	HELENE	Leht	2
Joonis	Wand A	Mootkava	1:50
Materjal	4.5x13.5	Kuup.	19.02.2019
Joonestas	File HELENE.dwg		

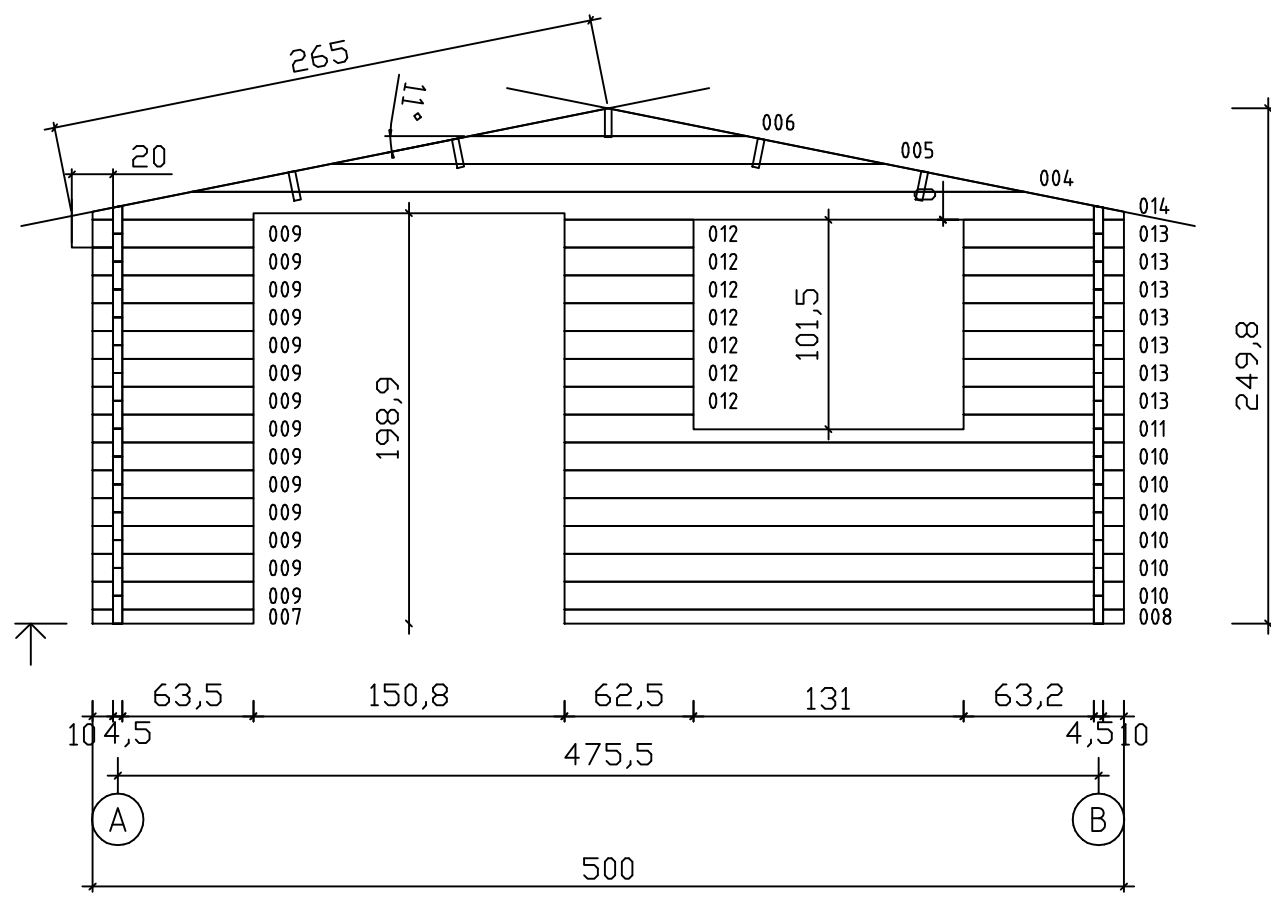

Wand 2

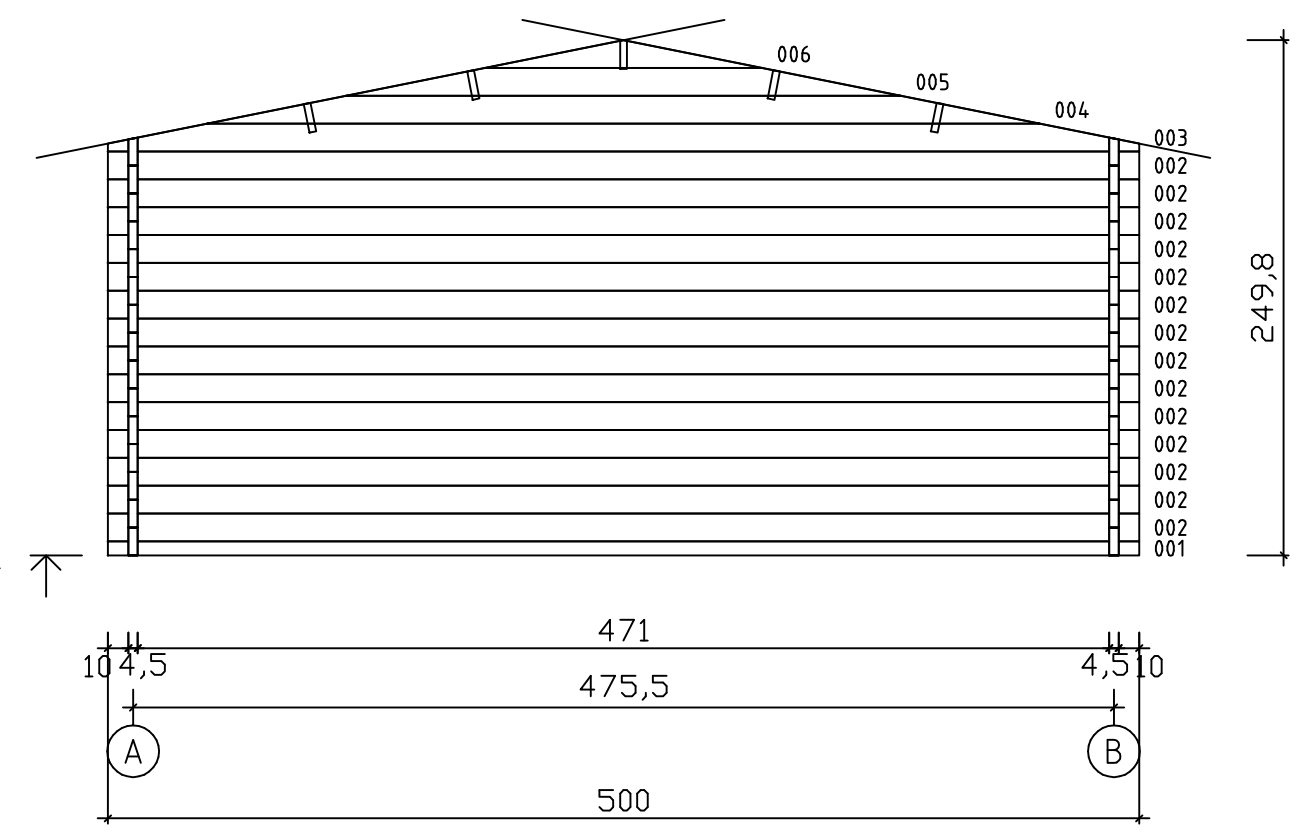

Wand 1

Kood	HELENE	Leht	4
Joonis	Wand 1	Mootkava	1:50
Materjal	4.5x13.5	Kuup.	19.02.2019
Joonestas	File HELENE.dwg		



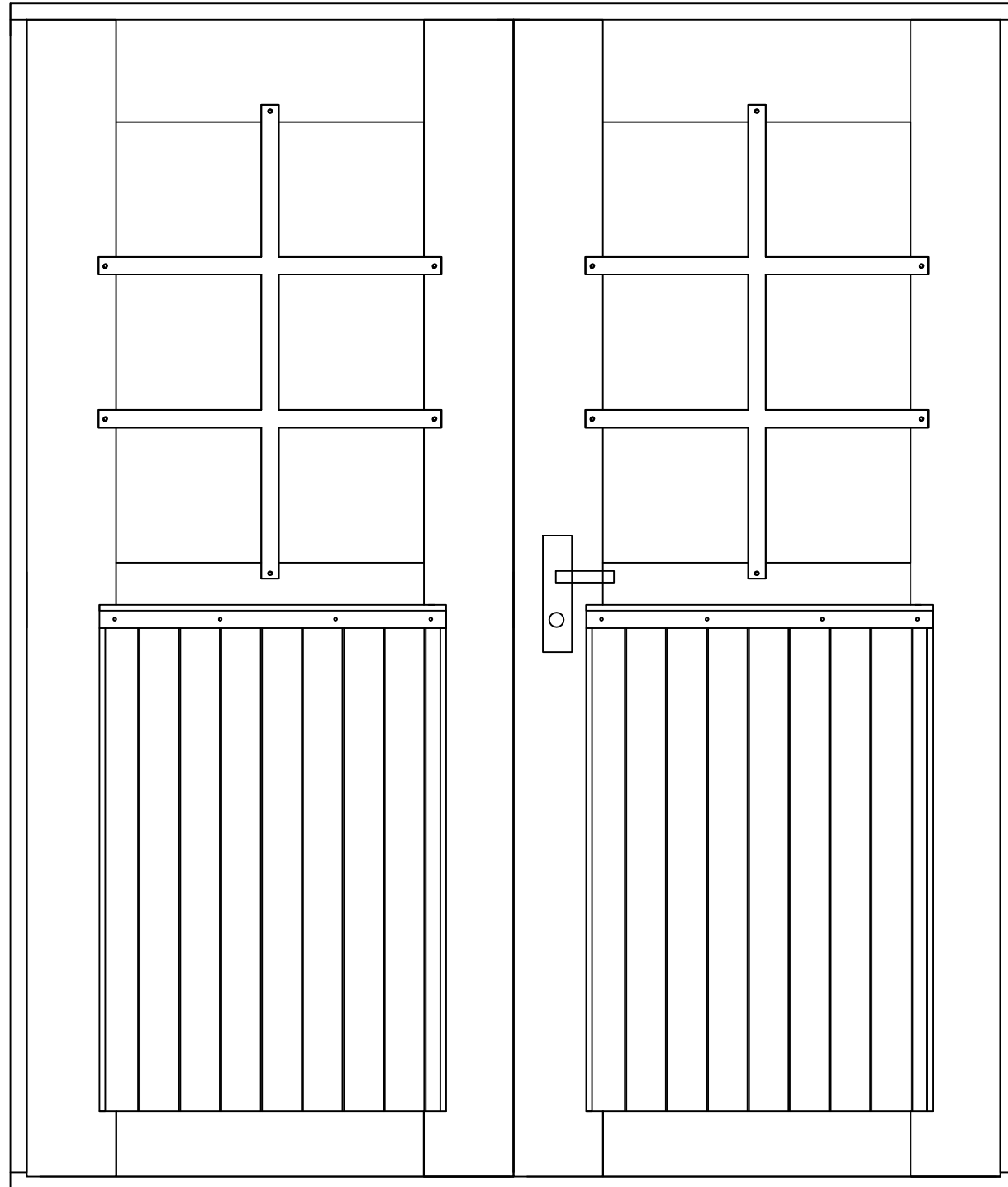

HELENE

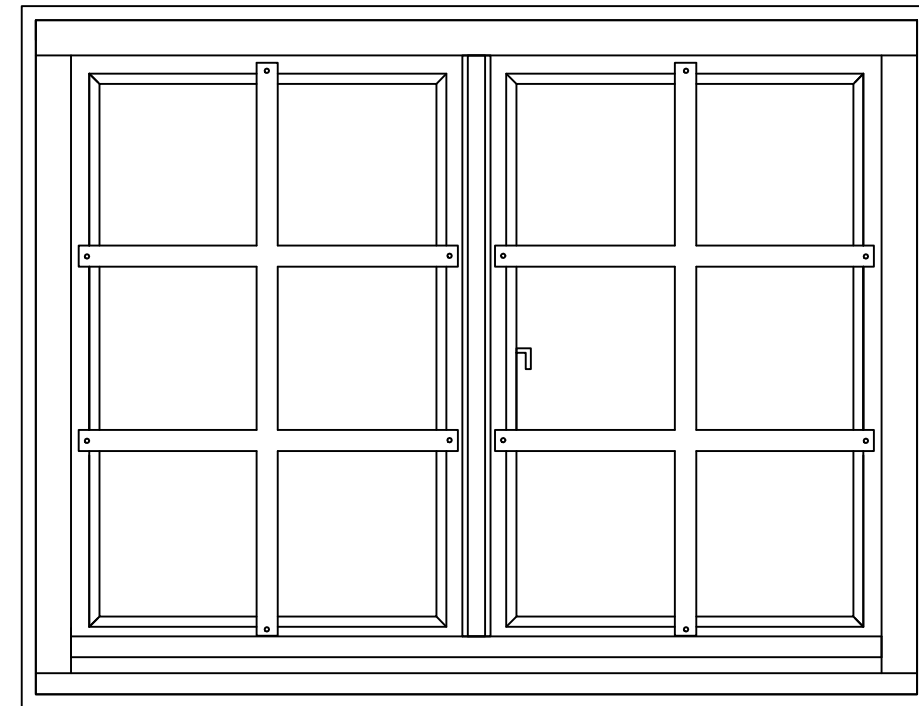



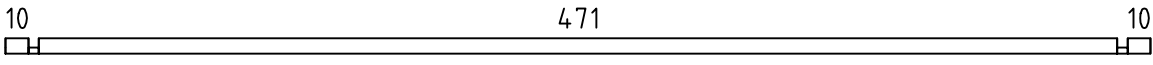
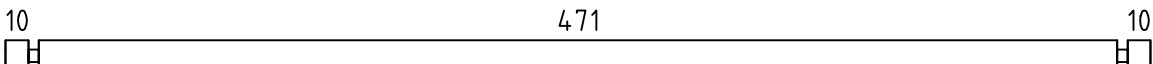
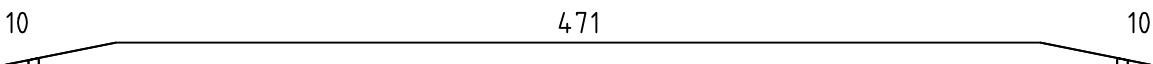
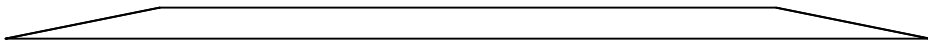
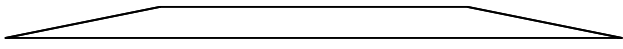
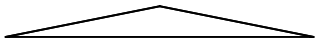
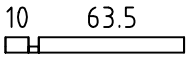
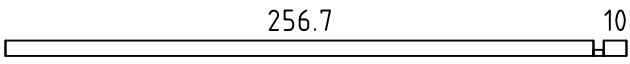
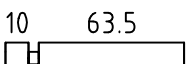
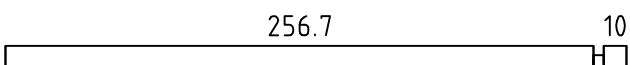
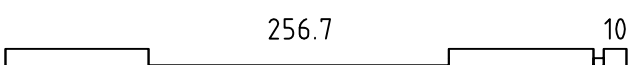
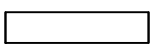
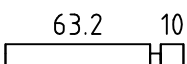
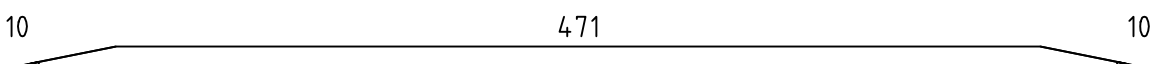
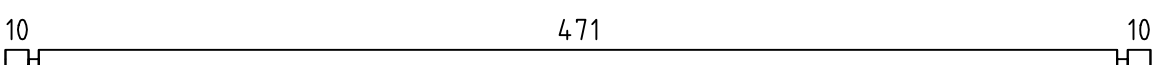
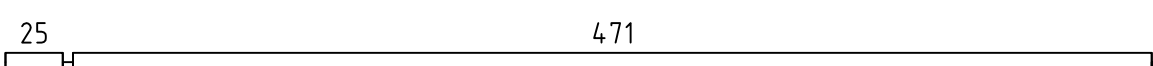
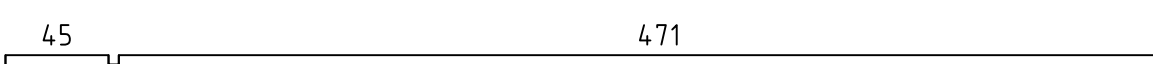
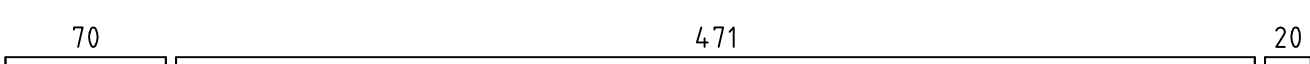



Doppelverglasung

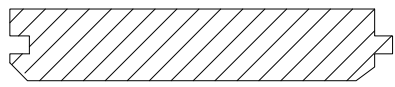

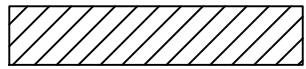
Doppelverglasung

Pos	Drawing HELENE	Pcs	Profile (cm)	Length (cm)
001		1	4.5x6.8	500
002		14	4.5x13.5	500
003		1	4.5x13.5	500
004		2	4.5x13.5	403.7
005		2	4.5x13.5	269.1
006		2	4.5x13.5	134.6
007		1	4.5x6.8	78
008		1	4.5x6.8	271.2
009		14	4.5x13.5	78
010		6	4.5x13.5	271.2
011		1	4.5x13.5	271.2
012		7	4.5x13.5	62.5
013		7	4.5x13.5	77.7
014		1	4.5x13.5	500
015		24	4.5x13.5	500
016		2	4.5x13.5	515
017		2	4.5x13.5	535
018		1	4.5x13.5	570
019		1	4.5x13.5	570
PR1		4	4.3x14.5	570
PR2		1	4.3x14.5	570
	WINDOW 129x99	1		
	DOOR 149.4x196.4	1		
Kood HELENE		Materjal		File HELENE.dwg
				Leht 1/1

Pos	Drawing HELENE		Pcs	Profile (cm)	Length (cm)
020	ROOF BOARDS/DACHBRETTER/VOLIGE		102 84	11.2x1.6 13.7x1.6	265 265
021	ROOF EDGE REINFORCEMENT/TRAUFFENLEISTE/TASSEAU		2	2.6x3.2	570
022	ROOF SIDE BOARDS/TRAUFFENBRETT/PLANCHE DE RIVE		2	1.8x6	570
023	FASCIA BOARD/GIEBELBLENDE/PLANCHE DE RIVE (FACADE)		4	1.8x12.0	270
024	FASCIA BOARD/GIEBELBLENDE/PLANCHE DE RIVE (FACADE)		4	1.8x6.0	270
025	DIAMOND/RAUTE/DIAMANT		2	1.8x12	120
Kood HELENE		Material	File HELENE.dwg		Leht 2/2

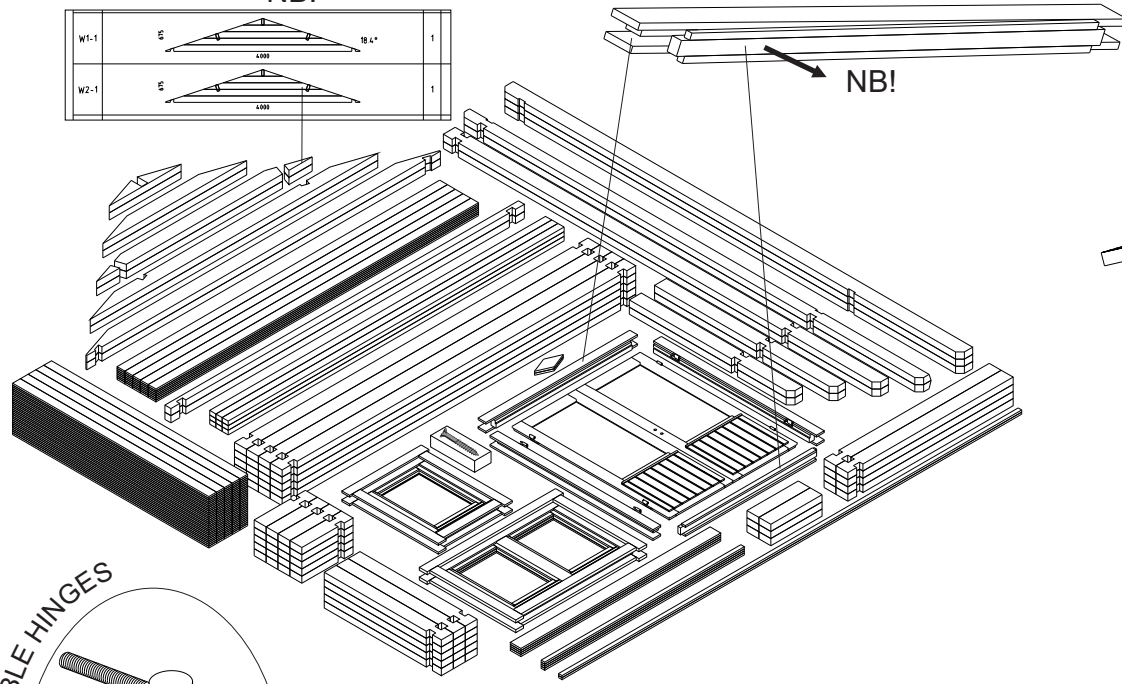
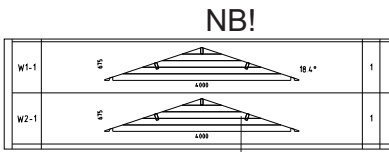

The guide is illustrative. This guide is not project specification.
 Der Leitfaden ist illustrativ. Dieser Leitfaden ist keine Projektspezifikation.
 De gids is illustratief. Deze gids is geen projectspecificatie.

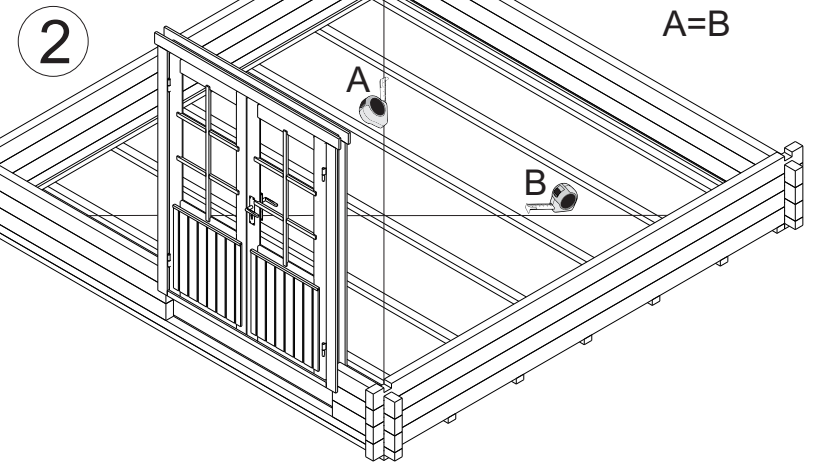
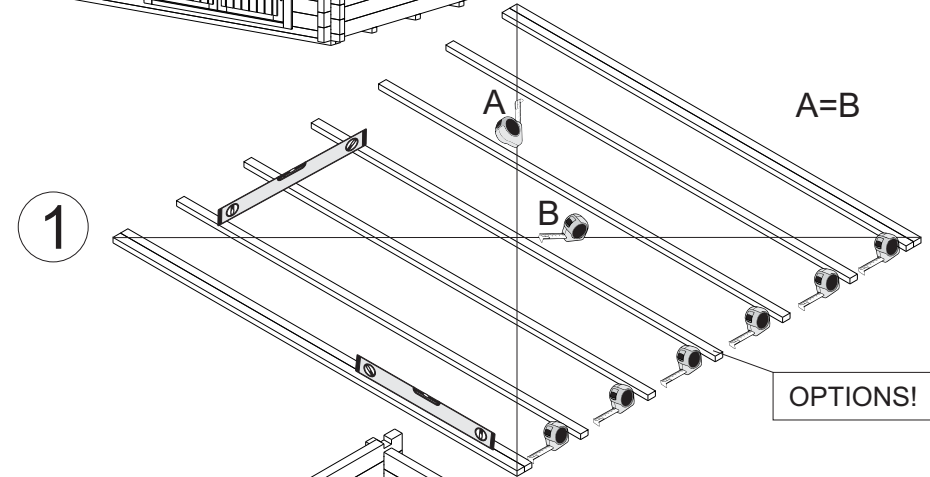
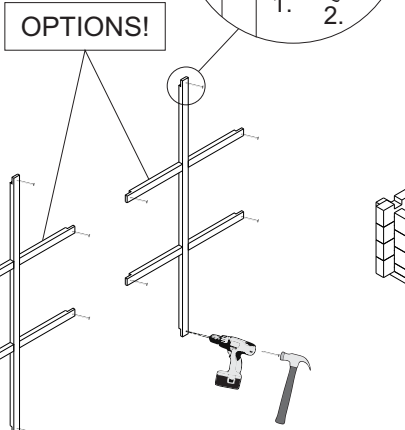
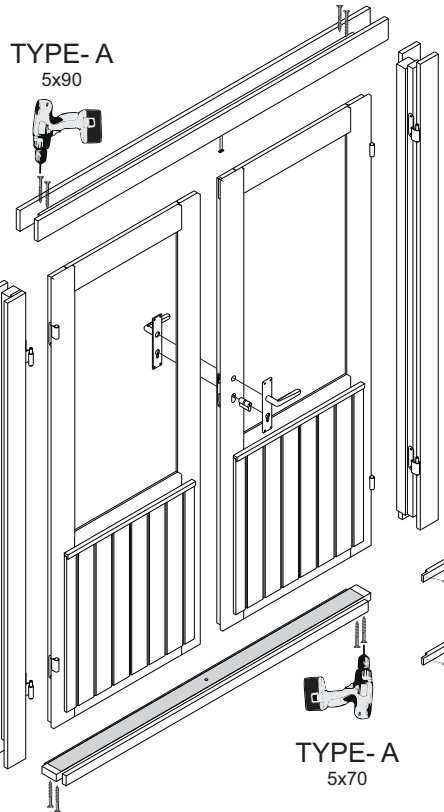
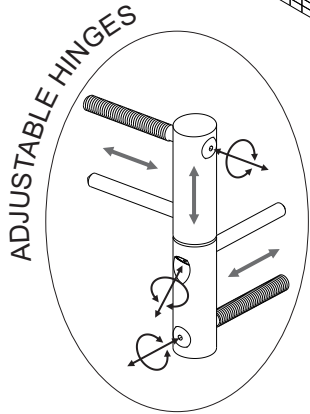
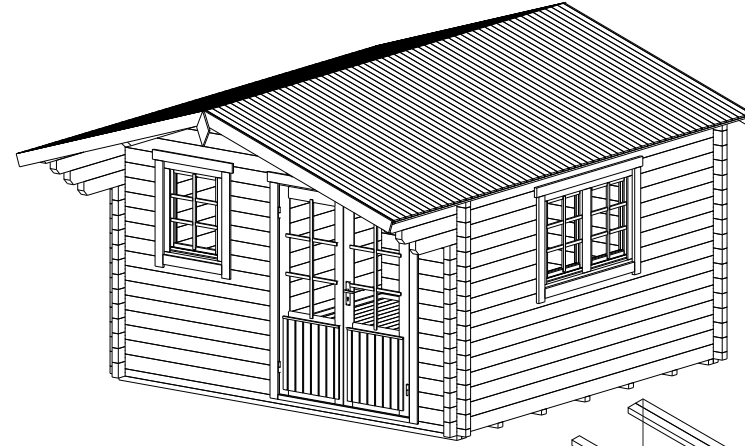

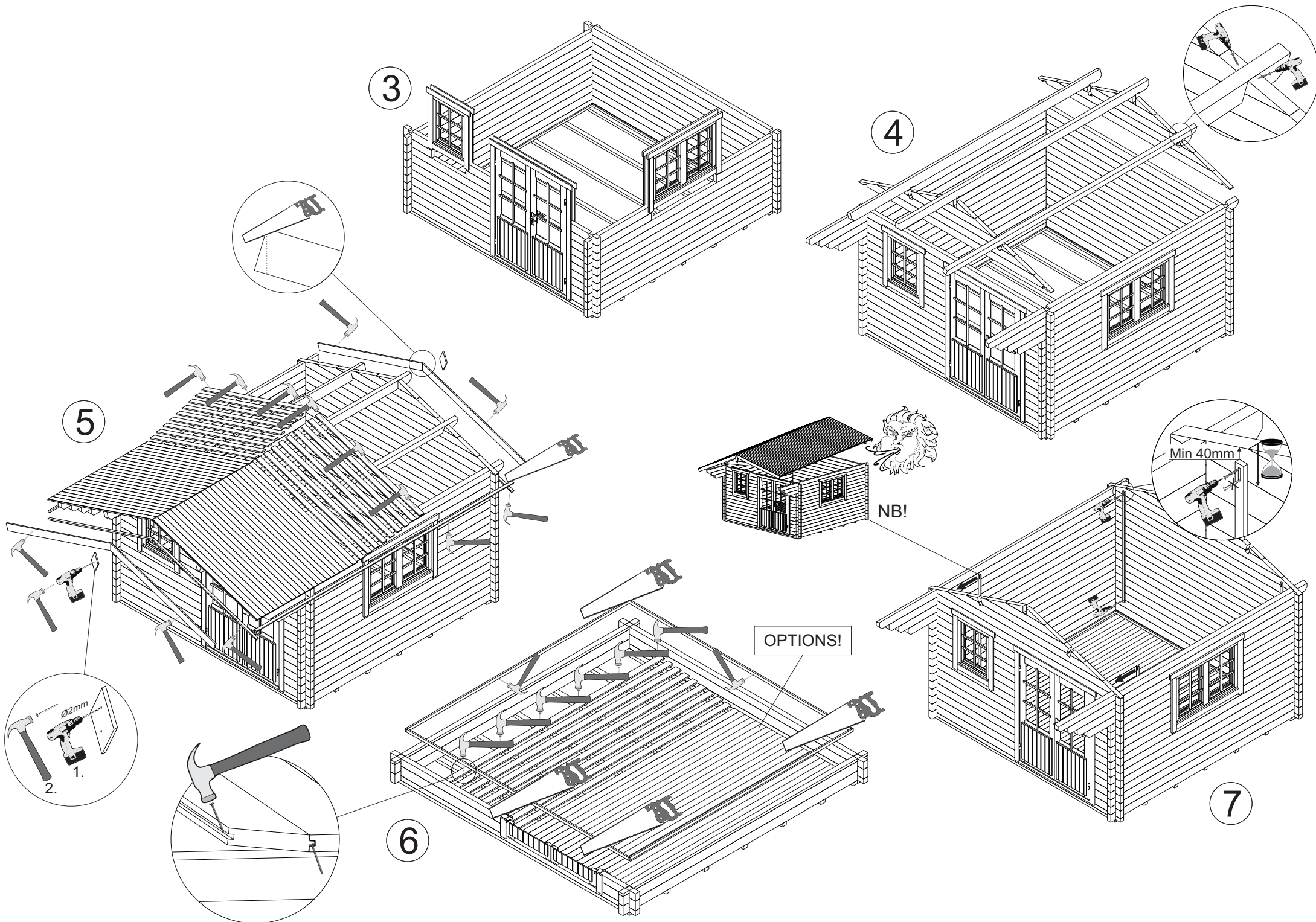

3

4

5

7

6

OPTIONS!

NB!

Min 40mm

