

# Oskar 40 ISO without floor

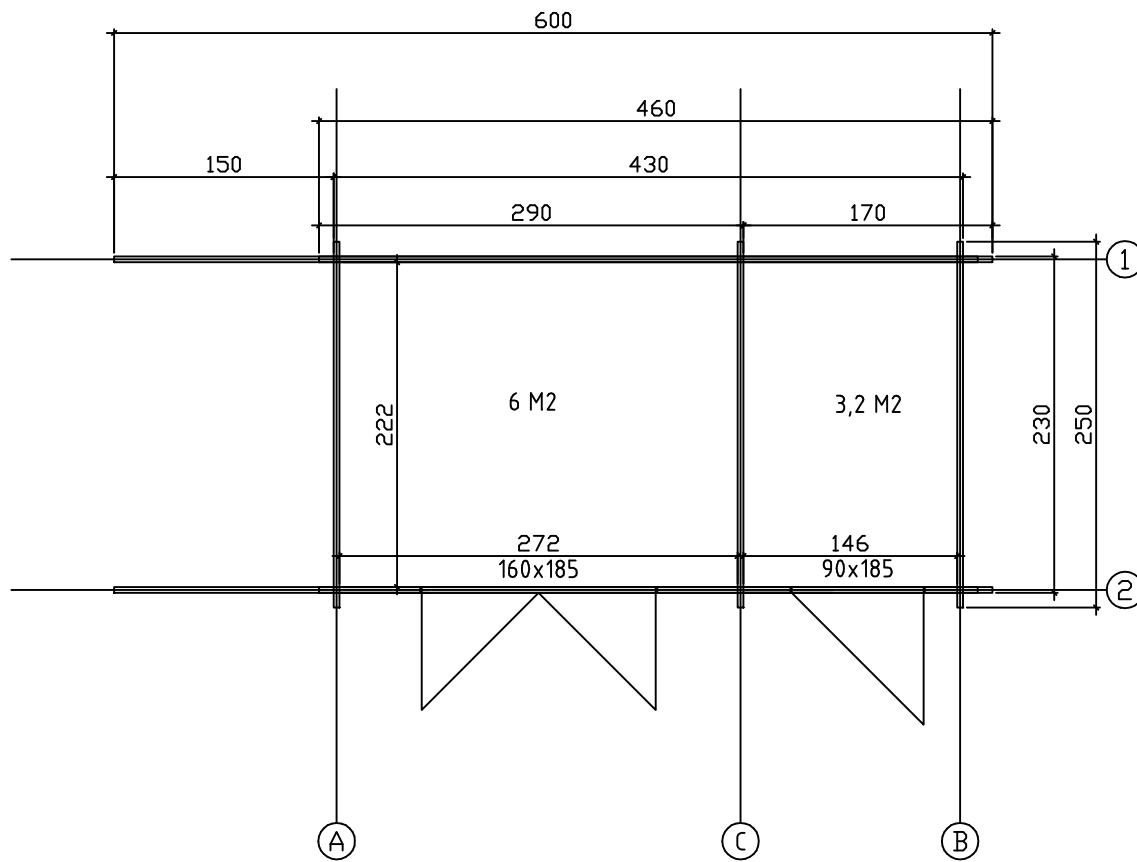

Kood	Oskar 40 ISO without floor	Leht	
Joonis	SEIN A	Mootkava	1:50
Materjal	4,0x13,5	Kuup.	09.08.2019
Joonestas	File Oskar 40 ISO wit		

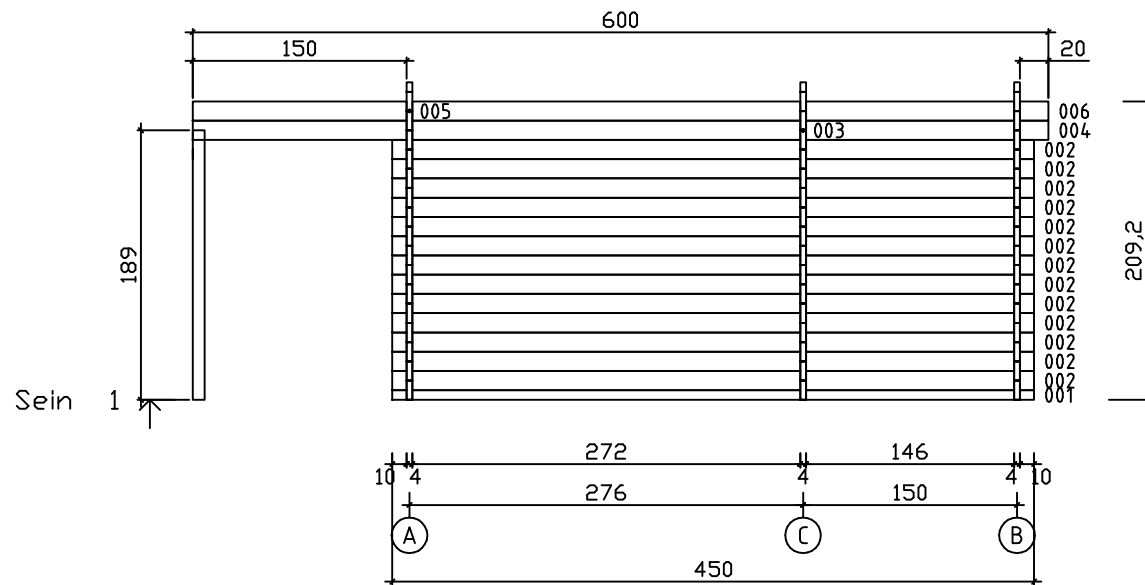





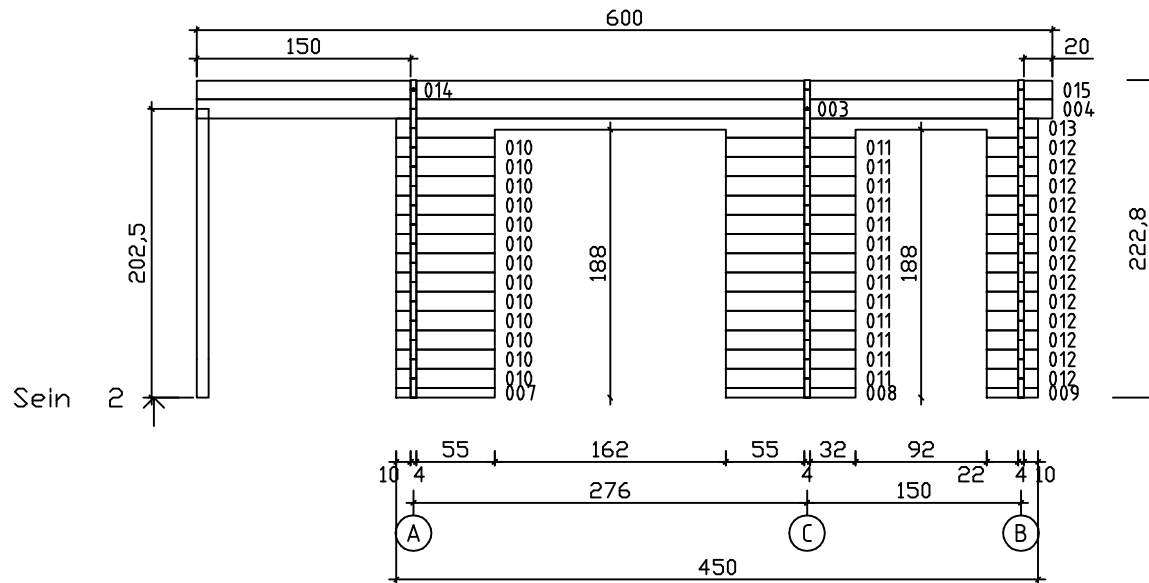

Kood	Oskar 40 ISO without floor	Leht	2
Joonis	SEIN 1	Mootkava	1:50
Materjal	4,0x13,5	Kuup.	09.08.2019
Joonestas		File	Oskar 40 ISO wit

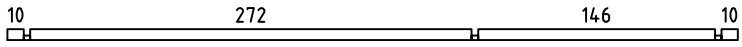
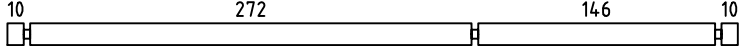
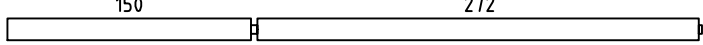
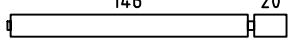
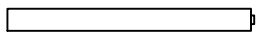
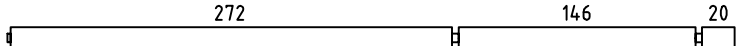
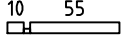
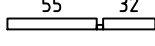

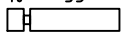

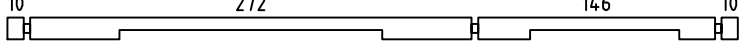
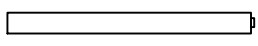
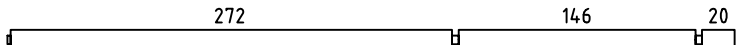
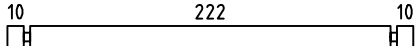
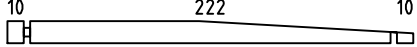
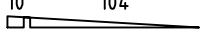
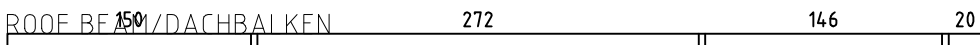





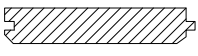

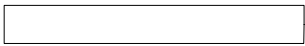
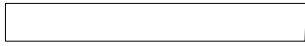
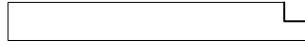
Kood	Oskar 40 ISO without floor	Leht	floor
Joonis	SEIN 2	Mootkava	1:50
Materjal	4.0x13.5	Kuup.	09.08.2019
Joonestas		File	Oskar 40 ISO wit

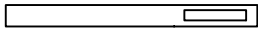
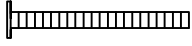
Pos	Drawing	Pcs	Profile (cm)	Length (cm)
001		1	4x6.8	450
002		13	4x13.5	450
003		2	4x13.5	428
004		2	4x13.5	172
005		1	4x13.5	152
006		1	4x13.5	448
007		1	4x6.8	69
008		1	4x6.8	91
009		1	4x6.8	36
010		13	4x13.5	69
011		13	4x13.5	91
012		13	4x13.5	36
013		1	4x13.5	450
014		1	4x12.9	152
015		1	4x12.9	448
016		45	4x13.5	250
017		3	4x13.5	250
018		3	4x6.8	118
PR1	 ROOF BEAM/DACHBALKEN	2	4.3x14.5	600

Kood Oskar 40 ISO with Mutter for

File Oskar 40 ISO without Mutter.dwg

Pos	Drawing	Pcs	Profile (cm)	Length (cm)
	Oskar 40 ISO without floor			
	DOOR 160x185 ISO RIGHT HAND OPENING / RECHTE HAND ERÖFFNUNG	1		
	DOOR 90x185 RIGHT HAND OPENING / RECHTE HAND ERÖFFNUNG	1		
	SASH BARS FOR DOUBLE DOOR / SPROSSEN FÜR DOPPEL-TÜR	2		
020	ROOF BOARDS/DACHBRETTER 	54 45	11.2x1.8 13.7x1.8	270 270
021	ROOF EDGE REINFORCEMENT/TRAUFENLEISTE 	2	2.6x3.2	6000
022	FASCIA BOARD/GIEBELBLENDE 	4	1.8x14.0	301.8
023	FASCIA BOARD/GIEBELBLENDE 	2	1.8x14.0	270
025	POST/PFOSTE 	1	8.3x8.3	189
026	POST/PFOSTE 	1	8.3x8.3	202.5
027	REGULATING BOLT 	2		
028	PULLER/STURMLEISTEN/GARNITURE SLAT 	4	2.6x3.2	216
038	BOLT/BOLZEN/BOULON 	8	M8	80
039	Shim, Nut/Mutter, M8 mm - For fixing storm braces/Für Sturmleisten 	8	M8	
040	Nails/Nägel/Clous 2.5 x 50 mm - For fixing roofboards Befestigung Dachbretter/ 	300		
041	Nails/Nägel/Clous 2.0 40 mm - For fixing roofing felt fillet Befestigung Giebelabschlusßbrett Pour fixer la latte de finition de la couverture (18 x 90 mm) 	24		
042	Screws/Schrauben/Vis 4 x 50 mm - For fixing roof side boards and roof edge reinforcement/Befestigung Traufenbretter und Traufenleisten 	60		
043	Screws/Schrauben/Vis 2.5X40 mm - For fixing window and door trims/ Befestigung Fenster und Türen 	30		
044	Nails/Nägel/Clous 1.4 x 40 mm - For fixing floor edge trims Befestigung Fußleisten 	20		
Kood Oskar 40 ISO with Mutter floor		File Oskar 40 ISO without floor.dwg		

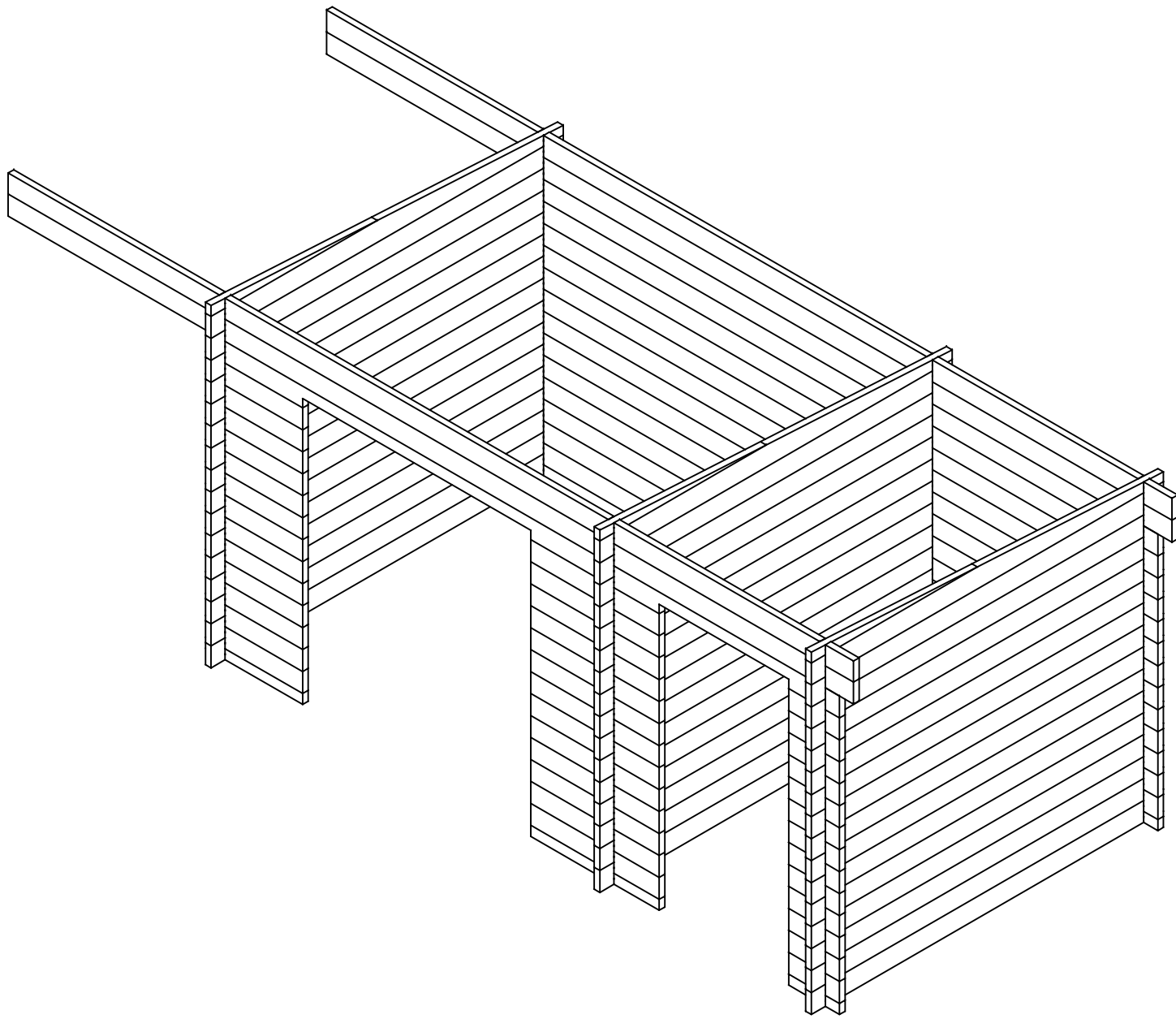

Oskar

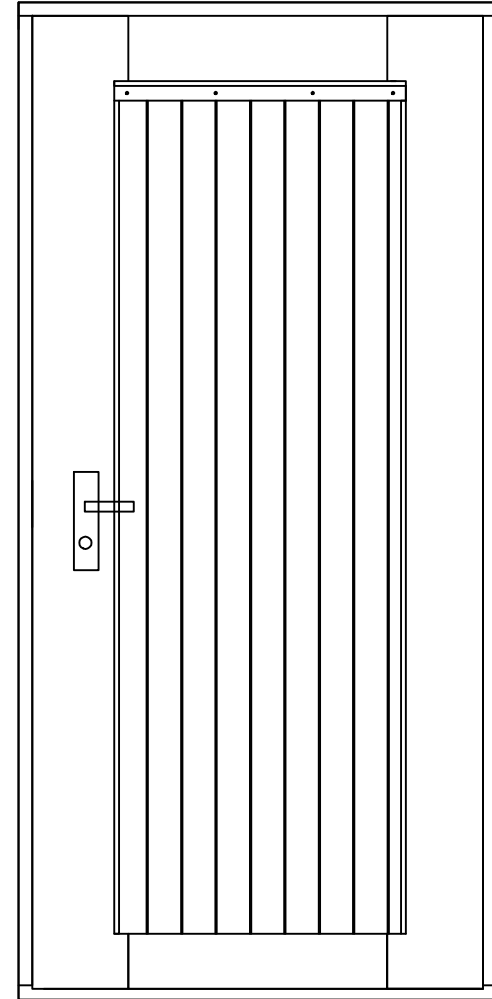
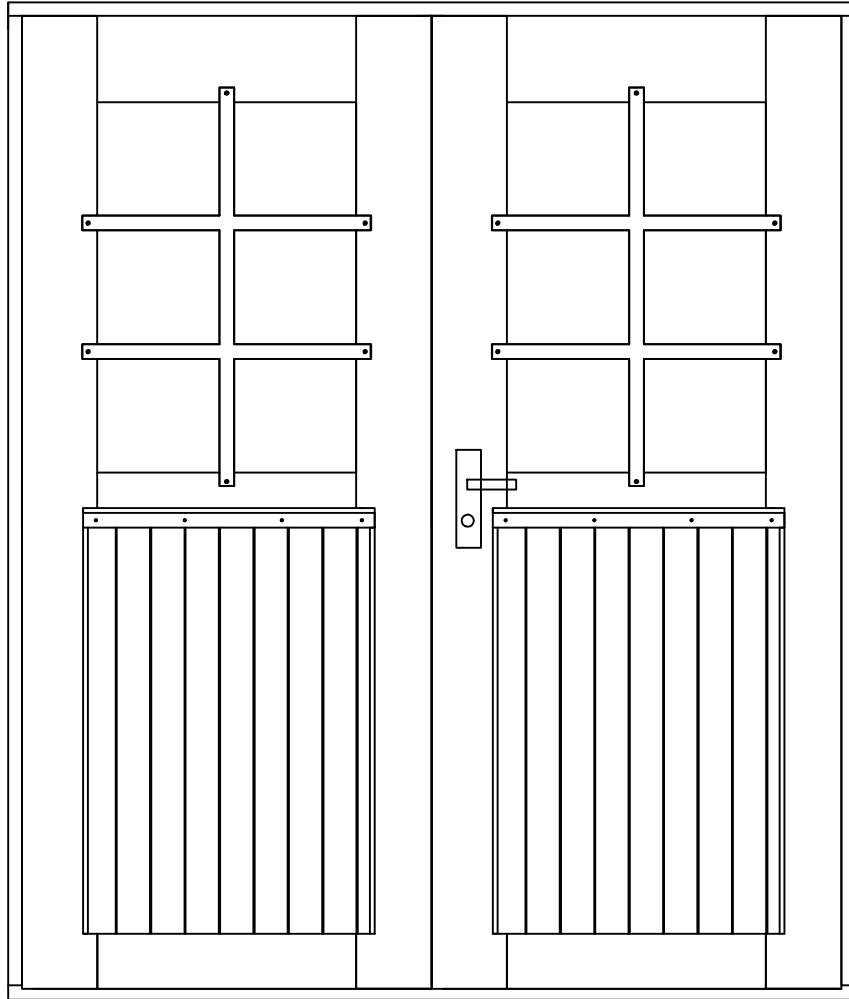



The guide is illustrative. This guide is not project specification.  
 Der Leitfaden ist illustrativ. Dieser Leitfaden ist keine Projektspezifikation.  
 De gids is illustratief. Deze gids is geen projectspecificatie.

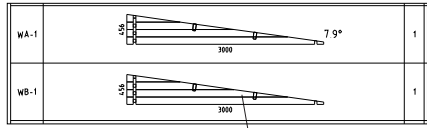

NB!

NB!

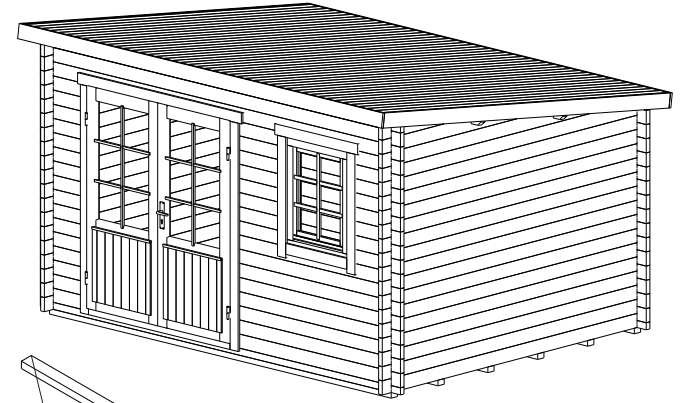
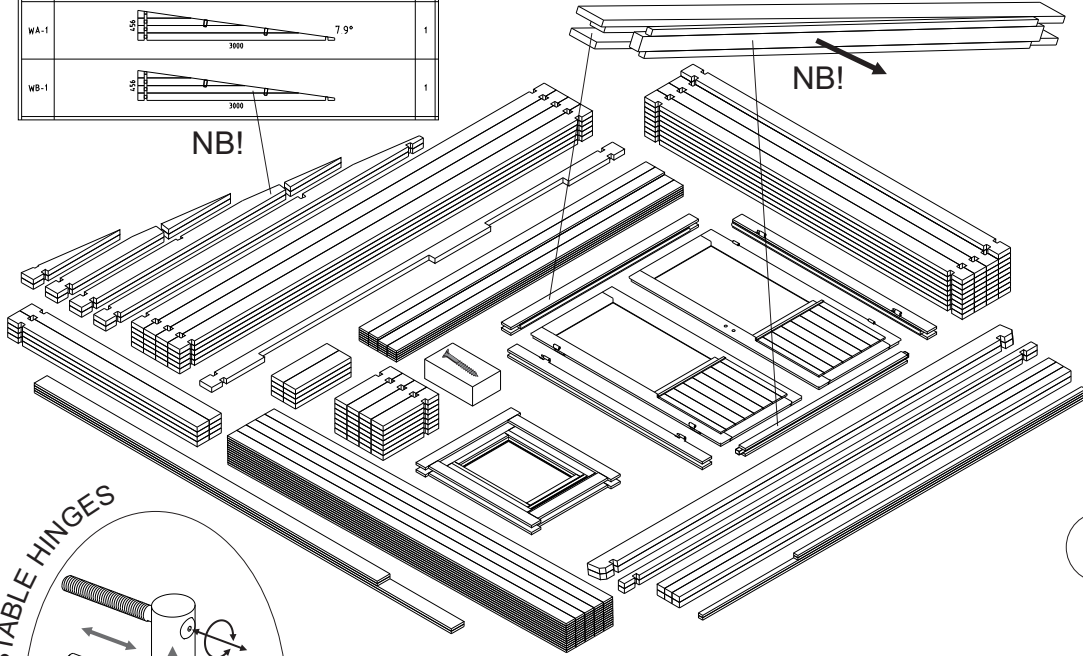

A=B

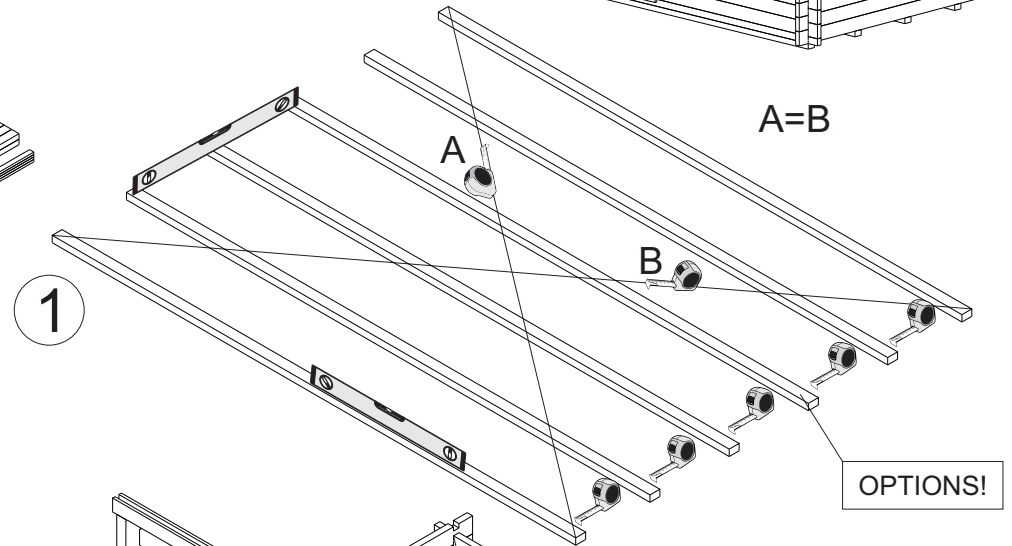

1

ADJUSTABLE HINGES

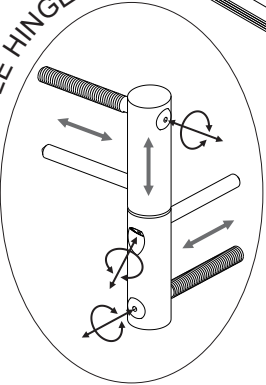

TYPE-B

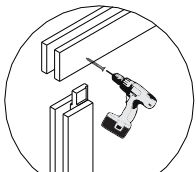

TYPE-B

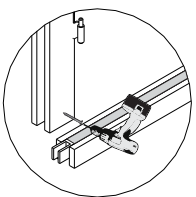

TYPE-A

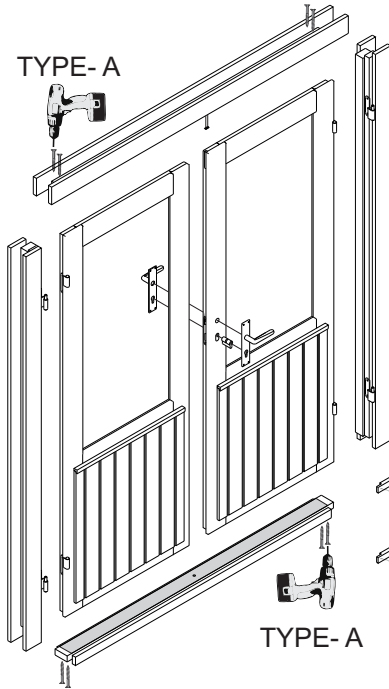

TYPE-A

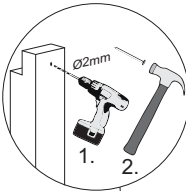

OPTIONS!

A=B

2

