

Date rev. Description

V 1.0

House	Raphael 4.4 ISO	Sheet	1
Drawing	3D	Scale	
Material	4.4x135	Date	18.06.2019
Drawer	K.K.	File	Raphael 4.4 ISO 3D.dwg

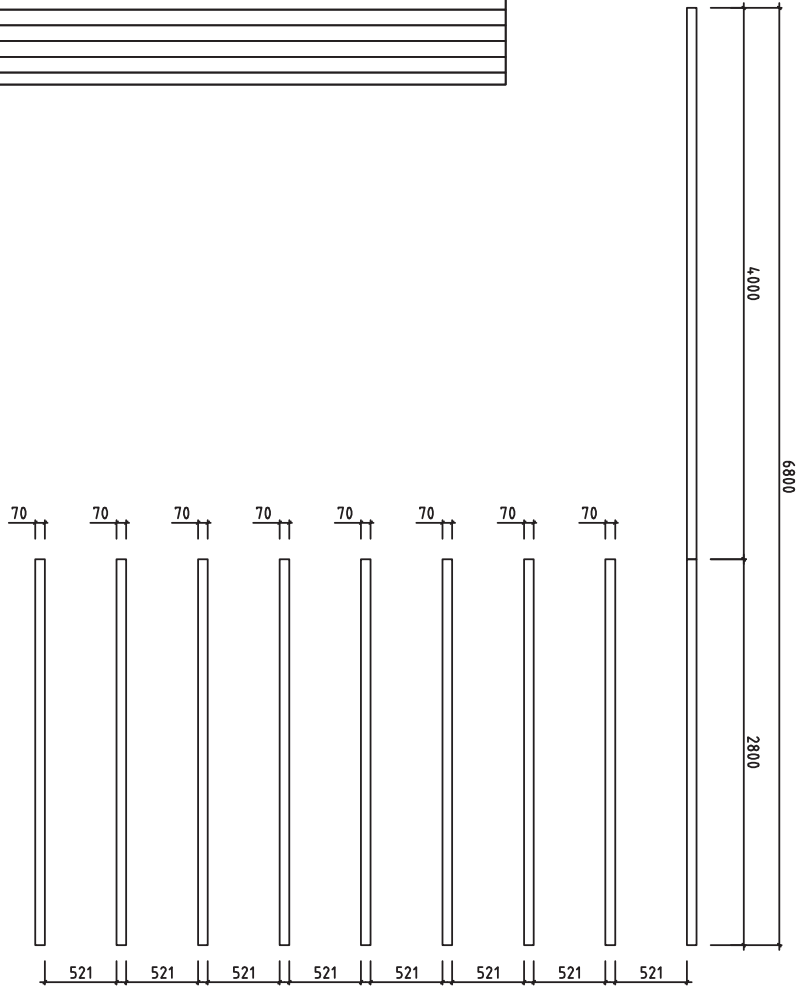
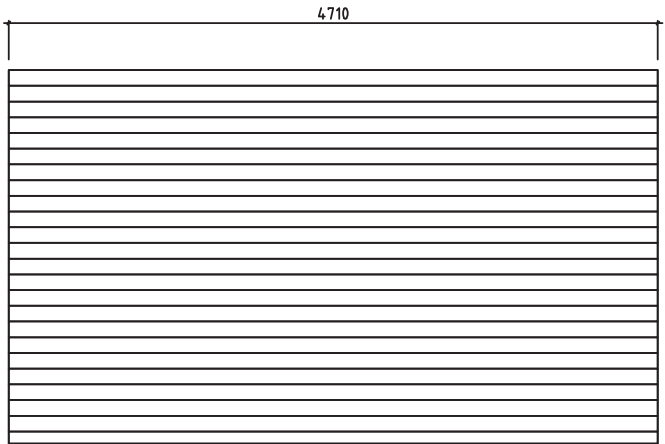

House	Raphael 44 ISO	Sheet	2
Drawing	FLOORBEAMS-FUSSBODENBALKEN-VIOERRALKEN	Scale	1:50
Material	70x45	Date	18.06.2019
Drawer	K.K.	File	Raphael 44 ISO.dwg

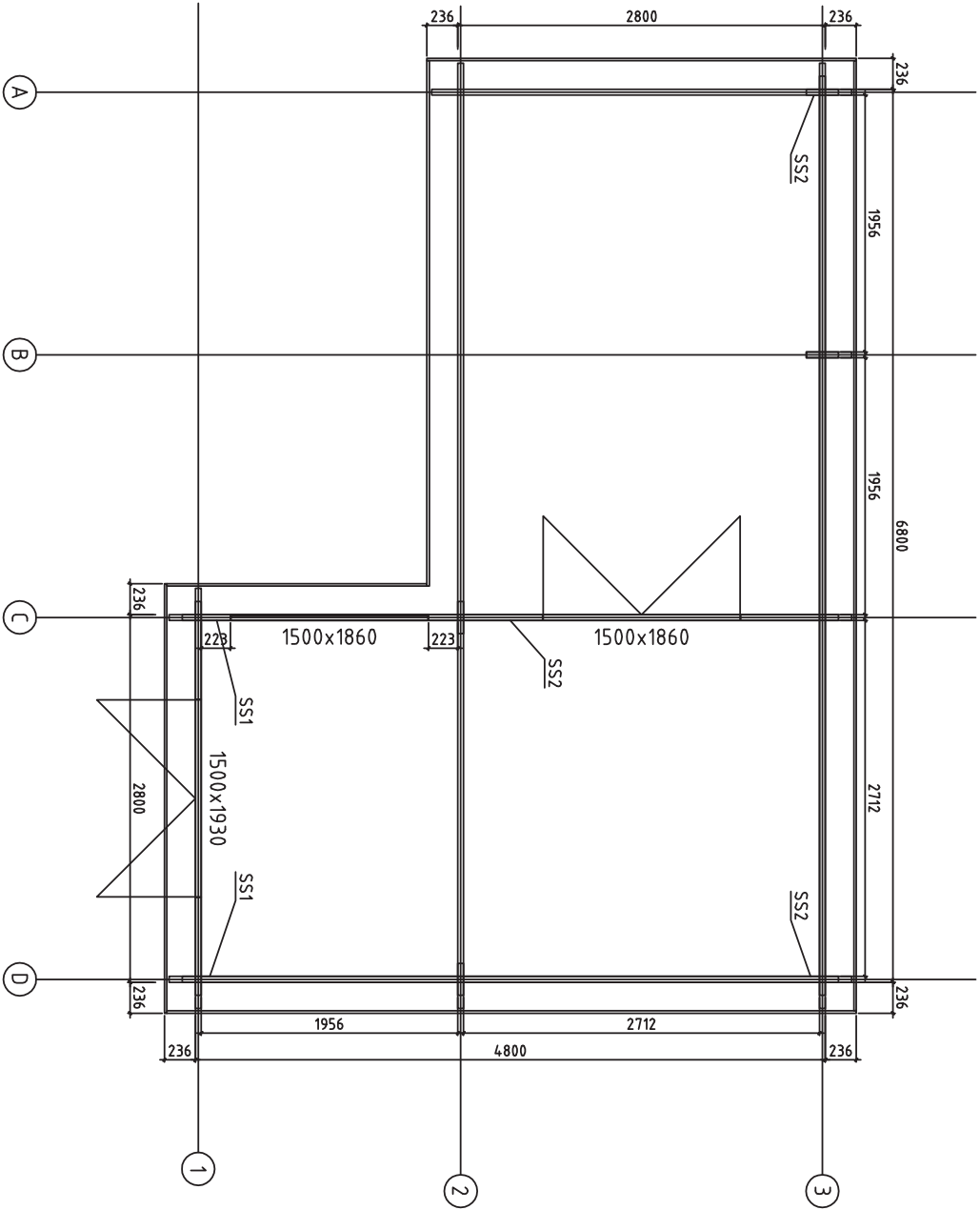

House	Raphael 44 ISO	Sheet	3
Drawing	Plan	Scale	1:50
Material	4,4x135	Date	18.06.2019
Drawer	K.K.	File	Raphael 44 ISO.dwg

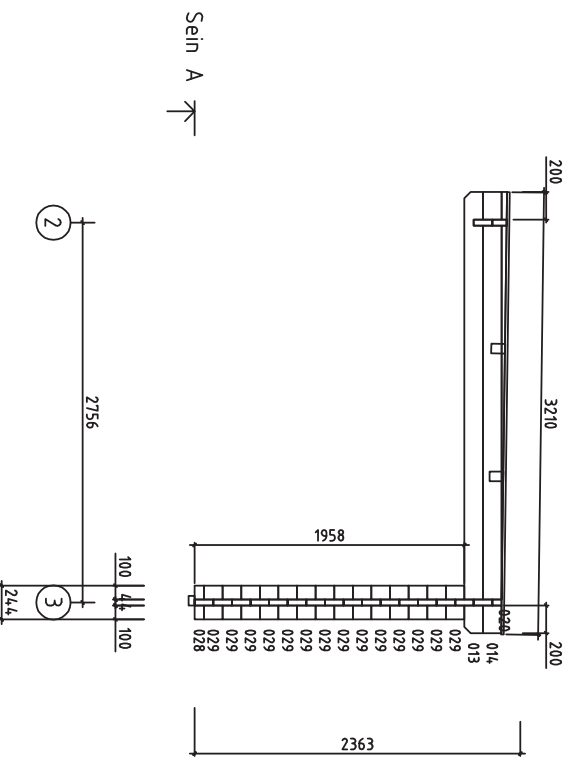

House	Rapphael 44 ISO	Sheet	4
Drawing	SEIN A	Scale	1:50
Material	4.4 x 13.5	Date	18.06.2019
Drawer	K.K.	File	Rapphael 44 ISO.dwg

Sein B ↗

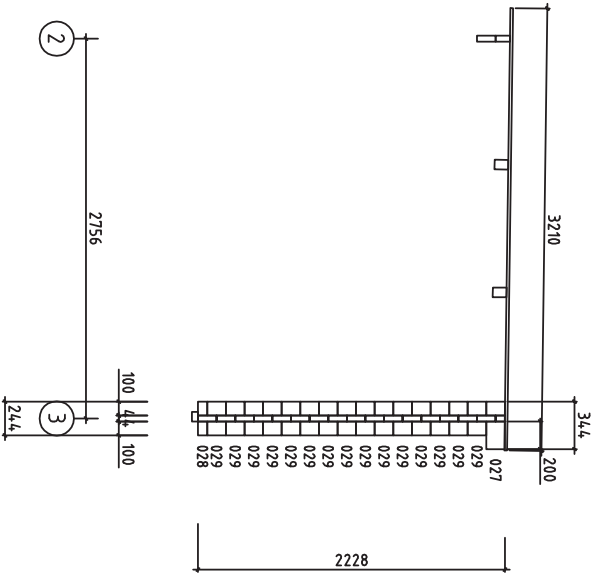

House	Raphael 44 ISO	Sheet	5
Drawing	SEIN B	Scale	1:50
Material	4.4 x 13.5	Date	18.06.2019
Drawer	K.K.	File	Raphael 44 ISO.dwg

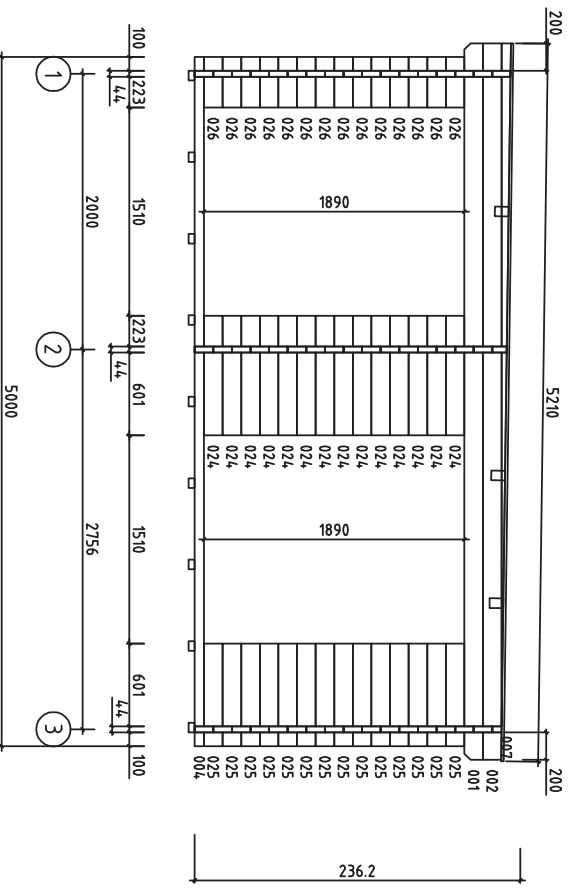

Sein C

House	Raphael 44 ISO	Sheet	6
Drawing	SEIN C	Scale	1:50
Material	4.4 x 13.5	Date	18.06.2019
Drawer	K.K.	File	Raphael 44 ISO.dwg

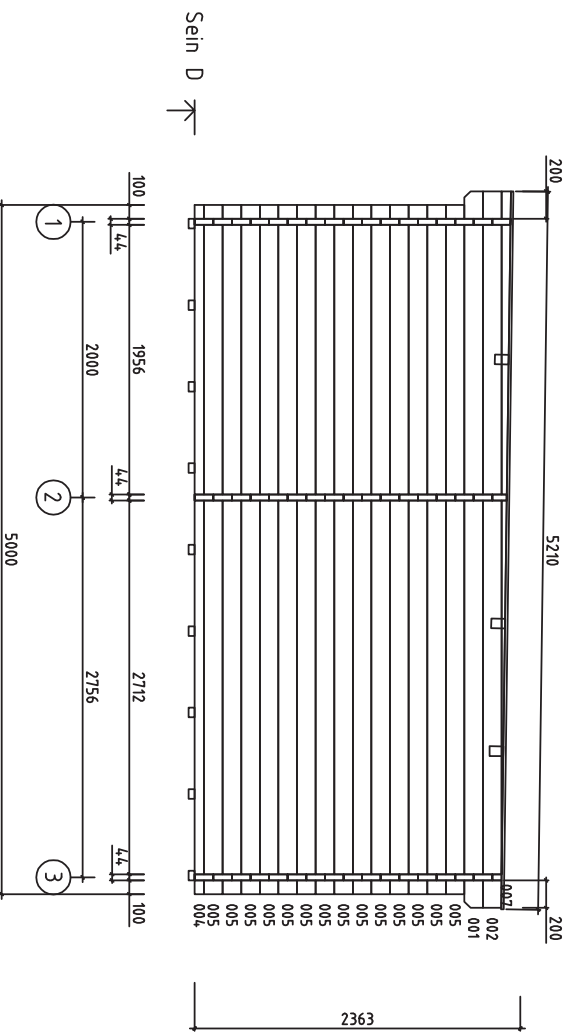

House	Raphael 44 ISO	Sheet	7
Drawing	SEIN D	Scale	1:50
Material	4.4 x 13.5	Date	18.06.2019
Drawer	K.K.	File	Raphael 44 ISO.dwg

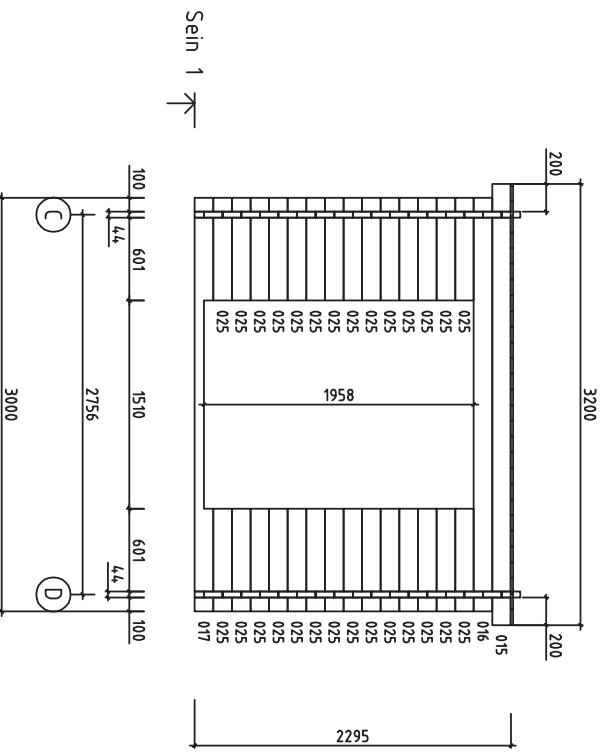

House	Raphael 44 ISO	Sheet	8
Drawing	SEIN 1	Scale	1:50
Material	4.4 x 13.5	Date	18.06.2019
Drawer	K.K.	File	Raphael 44 ISO.dwg

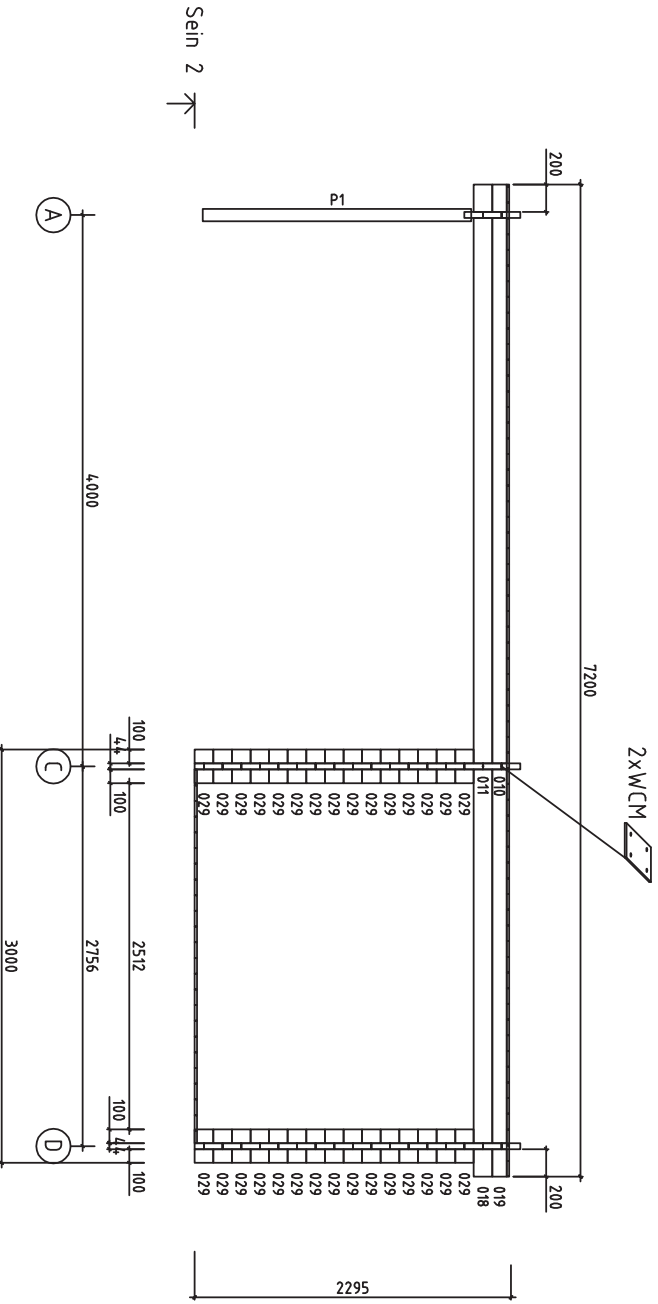

Sein 2 ↗

House	Raphael 44 ISO	Sheet	9
Drawing	SEIN 2	Scale	1:50
Material	4.4 x 13.5	Date	18.06.2019
Drawer	K.K.	File	Raphael 44 ISO.dwg

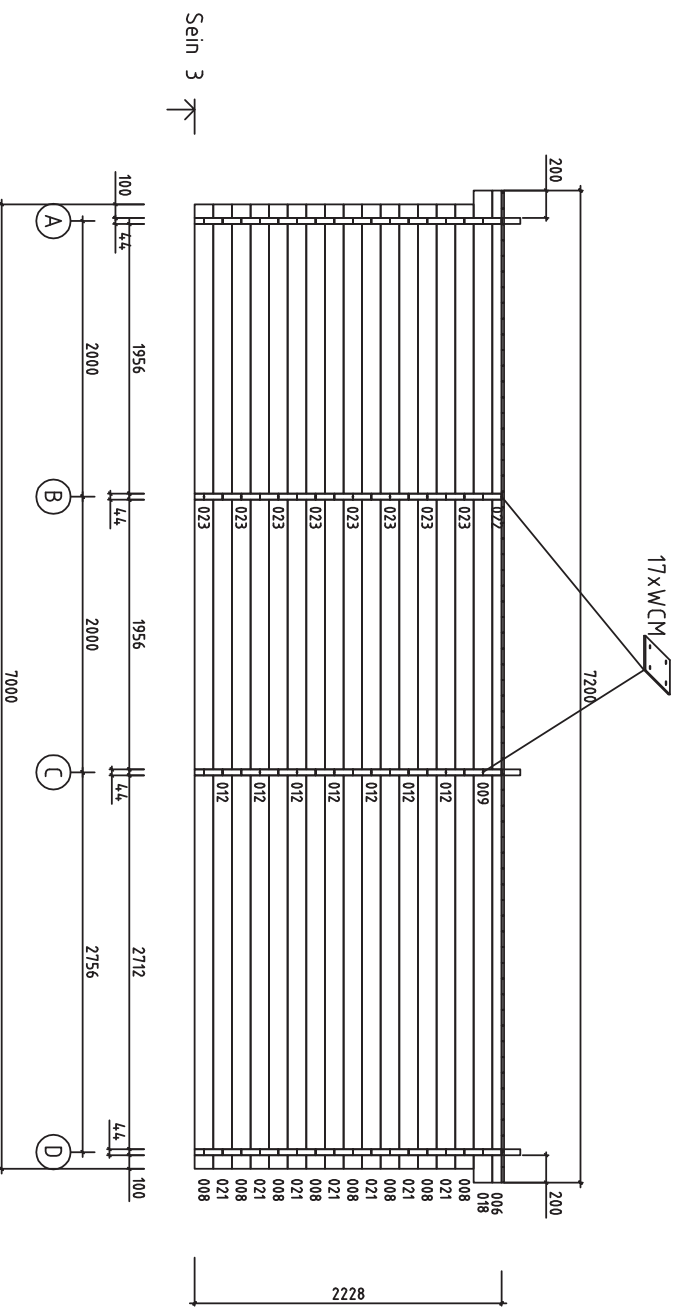



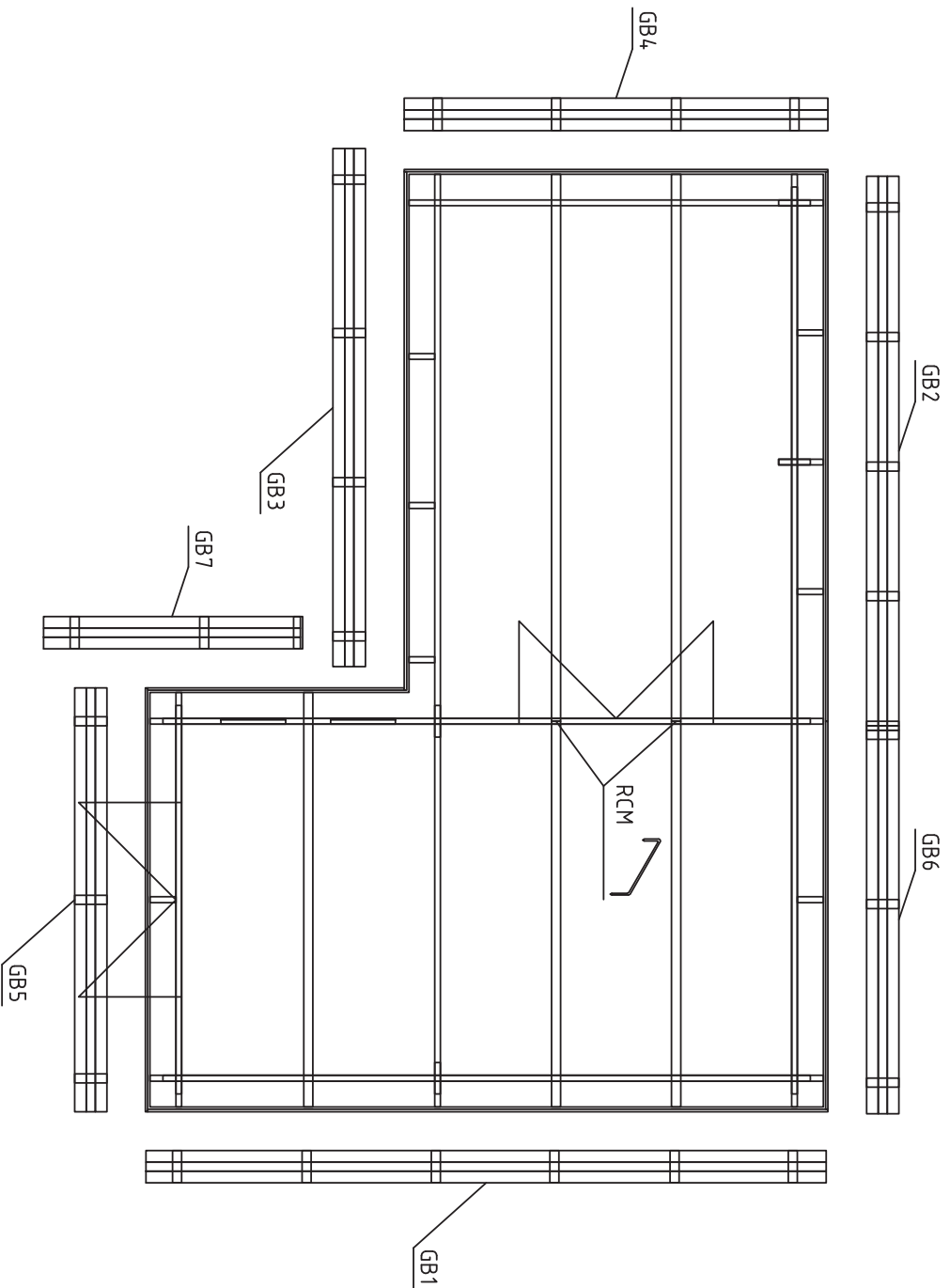





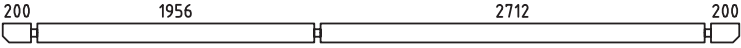
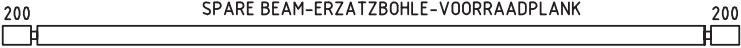
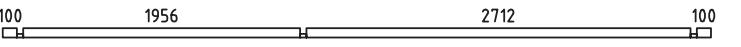
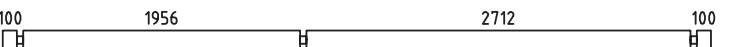
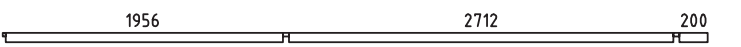

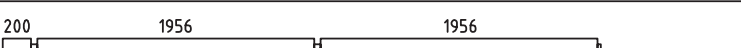
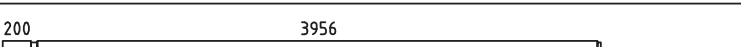

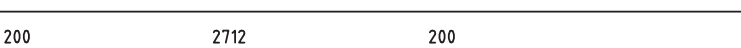
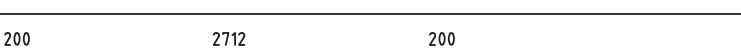
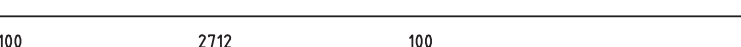

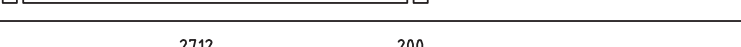
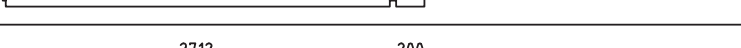
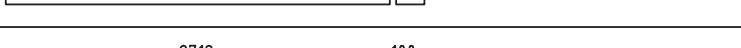
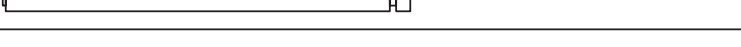
House	Raphael 4,4 ISO	Sheet	10
Drawing	SEIN 3	Scale	1:50
Material	4.4 x 13,5	Date	18.06.2019
Drawer	K.K.	File	Raphael 4,4 ISO.dwg











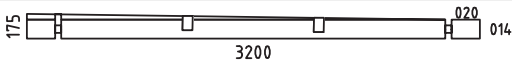
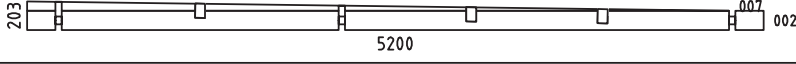
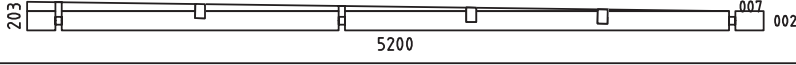



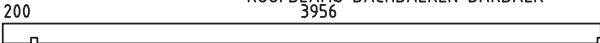
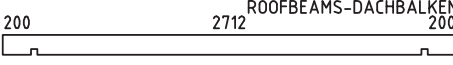
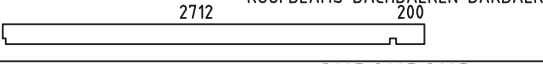
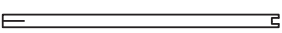

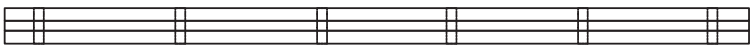

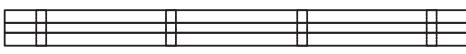

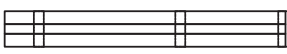
House	Raphael 44 ISO	Sheet	11
Drawing	ROOF-DACHN-DAK	Scale	1:50
Material		Date	18.06.2019
Drawer	K.K.	File	Raphael 44 ISO.dwg







PAKK Max 1700kg

Pos	Raphael 44 ISO	Pcs. St.	Profil(e) (mm)	L (mm)
001		2	44x135	5200
003		1	44x135	5200
004		2	44x68	5000
005		14	44x135	5000
006		1	44x68	4978
008		8	44x135	4878
009		1	44x135	4222
010		1	44x105	4222
011		1	44x135	4222
012		7	44x135	4122
013		1	44x135	3200
015		1	44x132	3200
016		1	44x135	3000
017		1	44x135	3000
018		2	44x135	2978
019		1	44x105	2978
021		7	44x135	2878
022		1	44x68	2222
023		8	44x135	2122
024		14	44x135	868
025		42	44x135	745
026		14	44x135	367
027		1	44x135	344
028		2	44x68	244
029		59	44x135	244
Kood	Raphael 44 ISO	Materjal	File Raphael 44 ISO.dwg	Leht 12

PAKK Max 1700kg

Pos	Raphael 44 ISO	Pcs. St.	Profil(e) (mm)	L (mm)
WA-1		1	44x175	3200
WC-1		1	44x203	5200
WD-1		1	44x203	5200
SH	HIT BLOCK-SCHLAGHÖLZER-BLAZENPLANK 	2	44x135	300
PT1	FLOORBEAMS-FUSSBODENBALKEN-VLOERBALKEN  IMM	1	70x45	4000
PT2	FLOORBEAMS-FUSSBODENBALKEN-VLOERBALKEN  IMM	9	70x45	2800
RB1	ROOFBEAMS-DACHBALKEN-DAKBALK  200 3956	2	70x140	4222
RB3	ROOFBEAMS-DACHBALKEN-DAKBALK  200 2712 200	1	70x140	3200
RB2	ROOFBEAMS-DACHBALKEN-DAKBALK  2712 200	2	70x140	2978
P1	POST-POST-POST 	1	90x90	1950
KT1		7	45x90	200
GB1		1	36x250	5254
GB2		1	36x250	4275
GB3		1	36x250	4000
GB4		1	36x250	3272
GB5		1	36x250	3272
GB6		1	36x250	2996
GB7		1	36x250	2000
F1	FLOORBOARD-FUSSBODENBRETT-VLOERPLANK  or	32+1 24+1	18x88 18x114	4710
R1	ROOFBOARD-DACHBRETT-DAKPLANK  or	38+1 29+1	18x88 18x114	5210
R2	ROOFBOARD-DACHBRETT-DAKPLANK  or	46 35	18x88 18x114	3210
FF1	FLOOR FILLET-FUSSBODENLEISTE-VLOERPLINT 		18x35	15.0
RCM	ROOFBEAMS CONNECTING METAL/DACHBALKEN BEFESTIGUNGSMETALLE  DAKBALKEN POOLING METALEN	2	∅6	200
WCM	WALLBEAMS CONNECTING METAL-WANDBOHLN BEFESTIGUNG METALLE  MUURBALKEN POOLING METALEN	19	25	25
PR1	POST REGULATOR-PFOSTEN REGLER-STUT REGELAAR 	1		
Kood	Raphael 44 ISO	Materjal	File Raphael 44 ISO.dwg	Leht 13

PAKK Max 1700kg

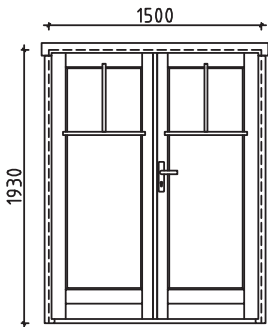
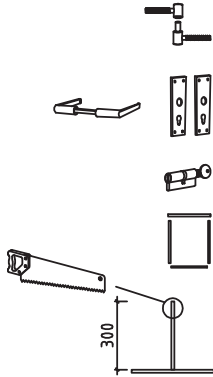
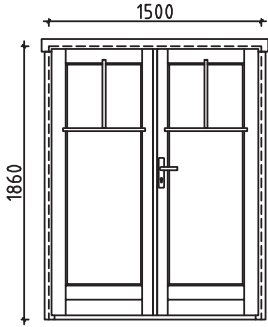
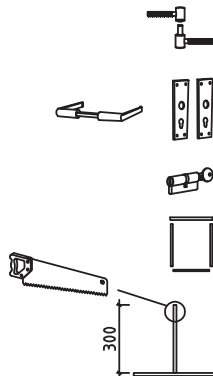
Pos	Raphael 44 ISO	Pcs. St.	Profil(e) (mm)	L (mm)
SS1	STORM SLAT-STURMLEISTE-STORMLIJST 	2	18x35	2200
SS2	STORM SLAT-STURMLEISTE-STORMLIJST 	3	19x35	2160
	SCREWS-SCHRAUBEN-SCHROEF (FOR-FÜR-VOOR STORM SLAT-STURMLEISTE-STORMLIJST) 	15	∅6	40
	WASHER-SCHEIBE-SCHIJF (FOR-FÜR-VOOR STORM SLAT-STURMLEISTE-STORMLIJST) 	15	∅6	
	NAIL-NAGEL-NAGEL FOR-FÜR-VOOR R1, R2, F1 	770	∅2.5	60
	SCREWS-SCHRAUBEN-SCHROEF FOR-FÜR-VOOR RB1 	6	∅6.0	160
	DOUBLEDOR-DOPPELTÜR-DUBBELE DEUR (right-rechts-rechts) AST_PRE P 	1	1500	1930
		6		
		1		
		1		
		1		
		2		
	DOUBLEDOR-DOPPELTÜR-DUBBELE DEUR (right-rechts-rechts) AST_PRE P 	1	1500	1860
		6		
		1		
		1		
		1		
		2		
Kood	Raphael 44 ISO	Materjal	File Raphael 44 ISO.dwg	Leht 14

PAKK Max 1700kg

Pos	Raphael 44 ISO	Pcs. St.	Profil(e) (mm)	L (mm)
	<p data-bbox="280 241 1117 277">WINDOW-FENSTER-VENSTER (closed-feststehend-gesloten) AST_ISO</p> 	1	1500	1860
Kood	Raphael 44 ISO	Materjal	File Raphael 44 ISO.dwg	Leht 15