

Date rev. Description

V 1.0

House	Sophia 4.4	Sheet	1
-------	------------	-------	---

Drawing	3D	Scale	
---------	----	-------	--

Material	4.4x135	Date	21.02.2020
----------	---------	------	------------

Drawer	K.K.	File	Sophia 4.4_3D.dwg
--------	------	------	-------------------

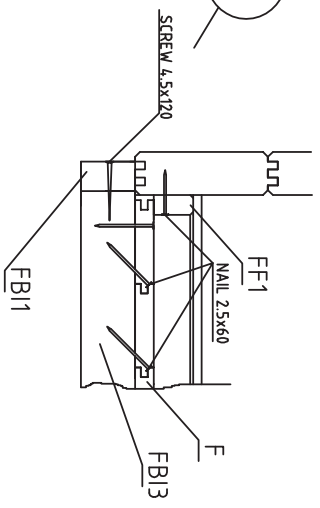
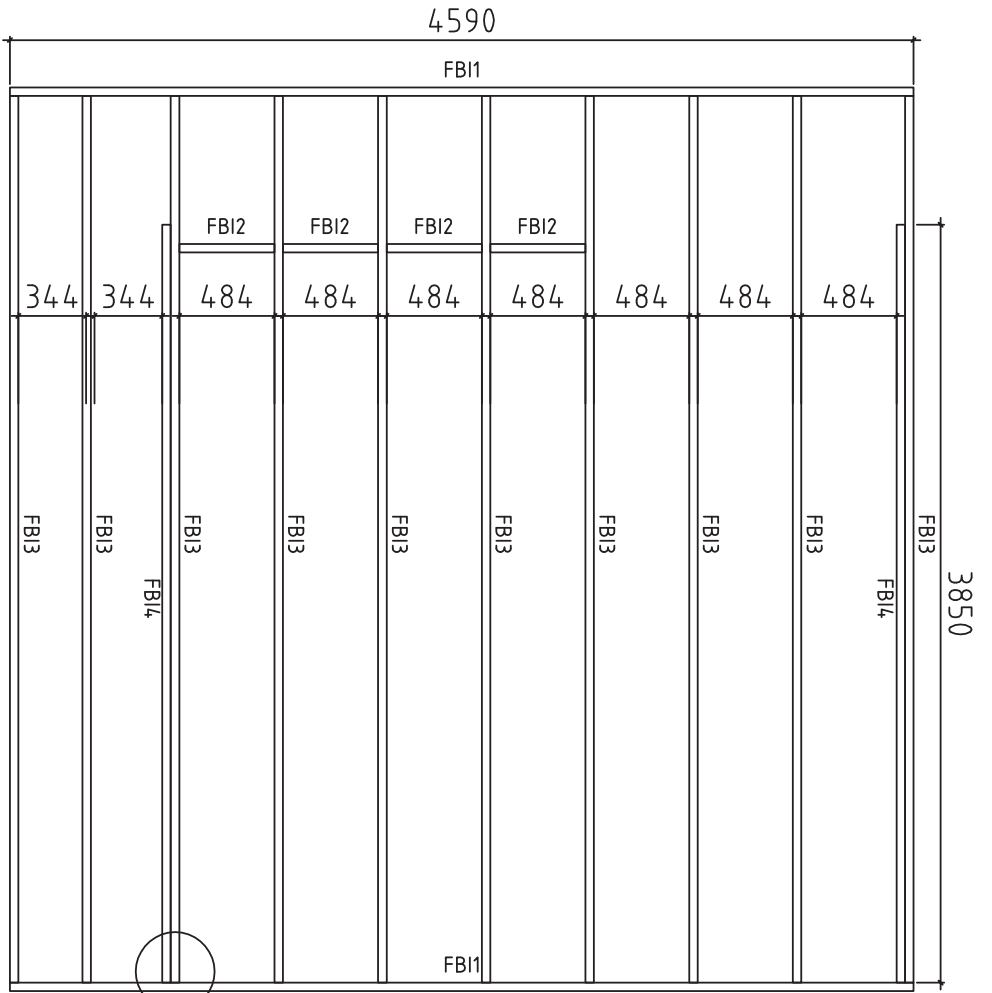

SCREW 4,5x120

House	Sophia 4.4	Sheet	2
Drawing		Scale	1:35
Material	4.3x70	Date	21.02.2020
Drawer	K.K.	File	Sophia 4.4.dwg

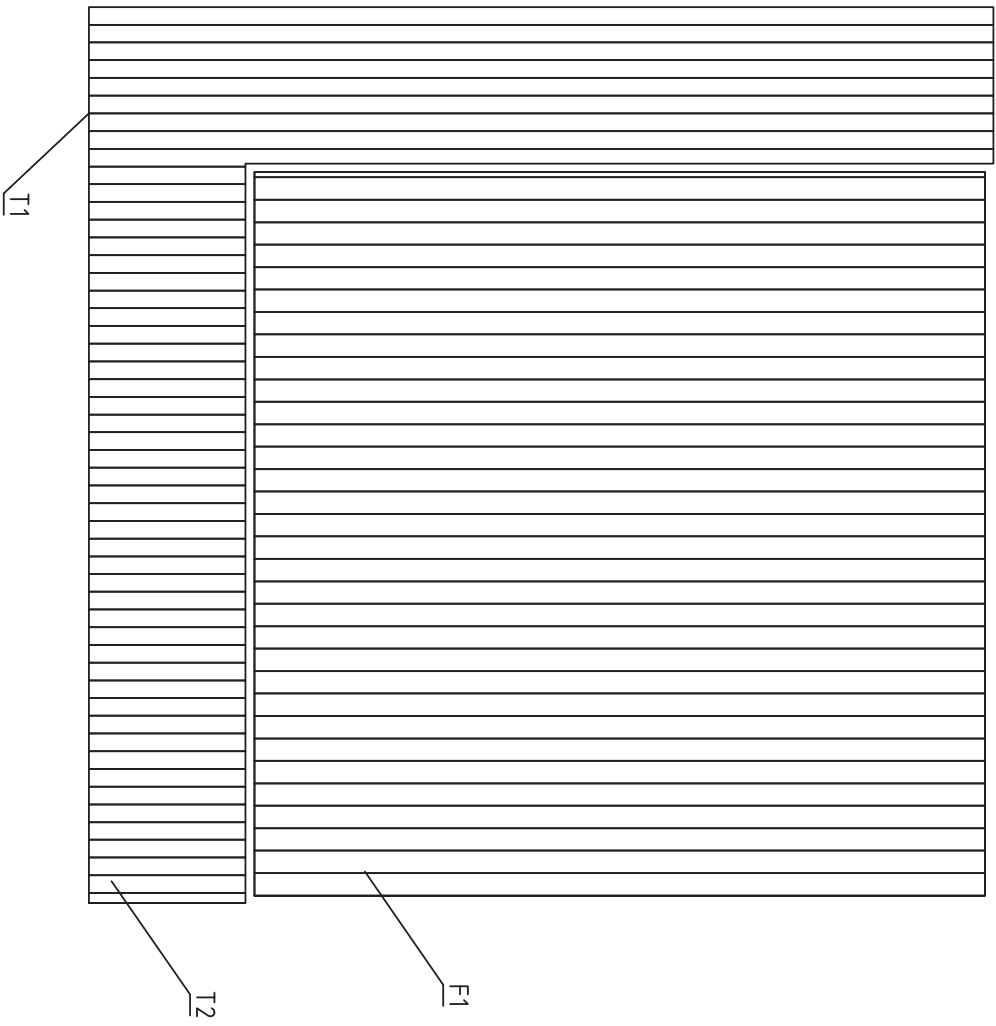

House	Sophia 44	Sheet	3
Drawing		Scale	1:35
Material	44x135	Date	21.02.2020
Drawer	K.K.	File	Sophia 44.dwg

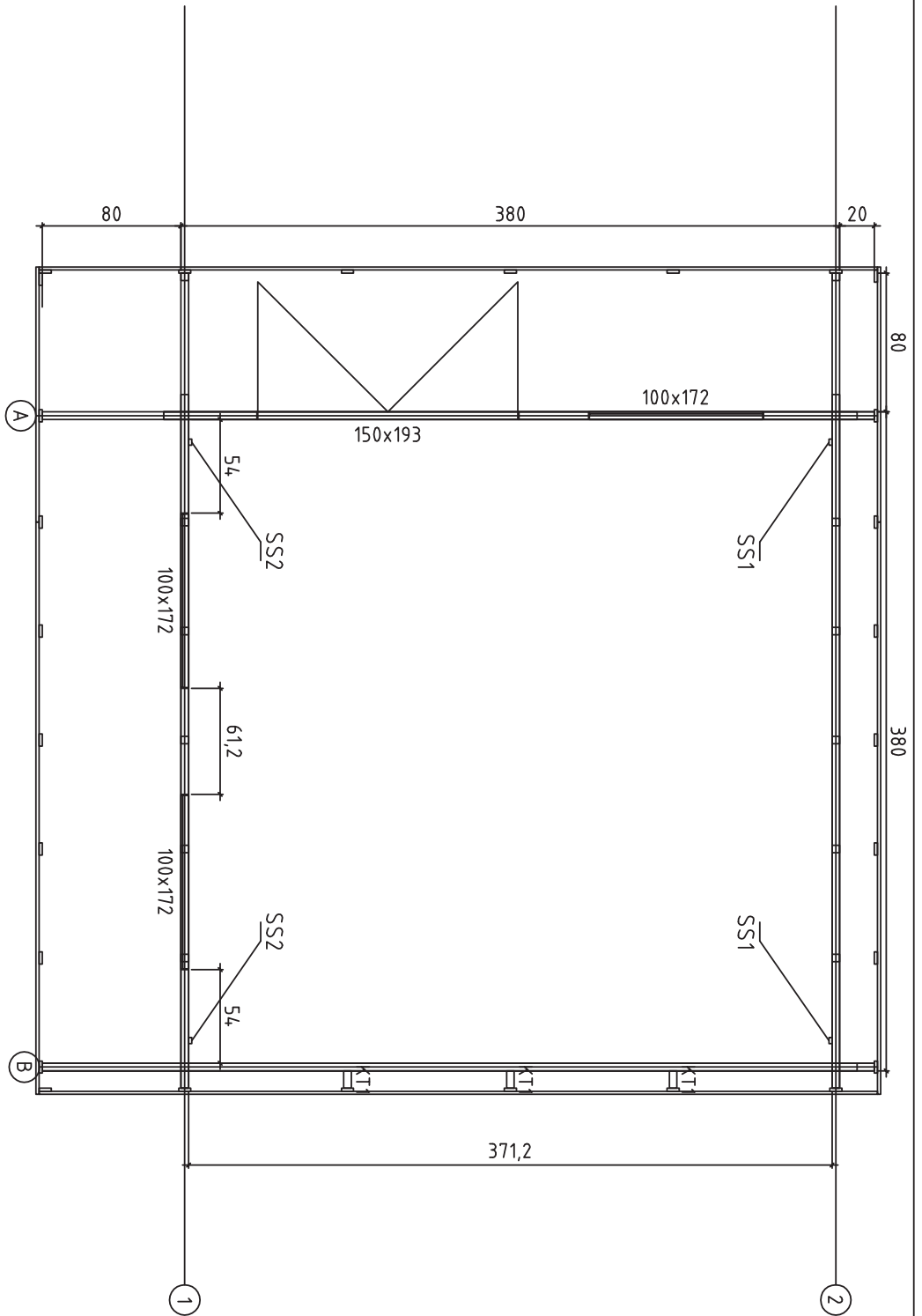

House	Sophia 4.4	Sheet	4
Drawing	Plan	Scale	1:35
Material	4.4x135	Date	21.02.2020
Drawer	K.K.	File	Sophia 4.4.dwg

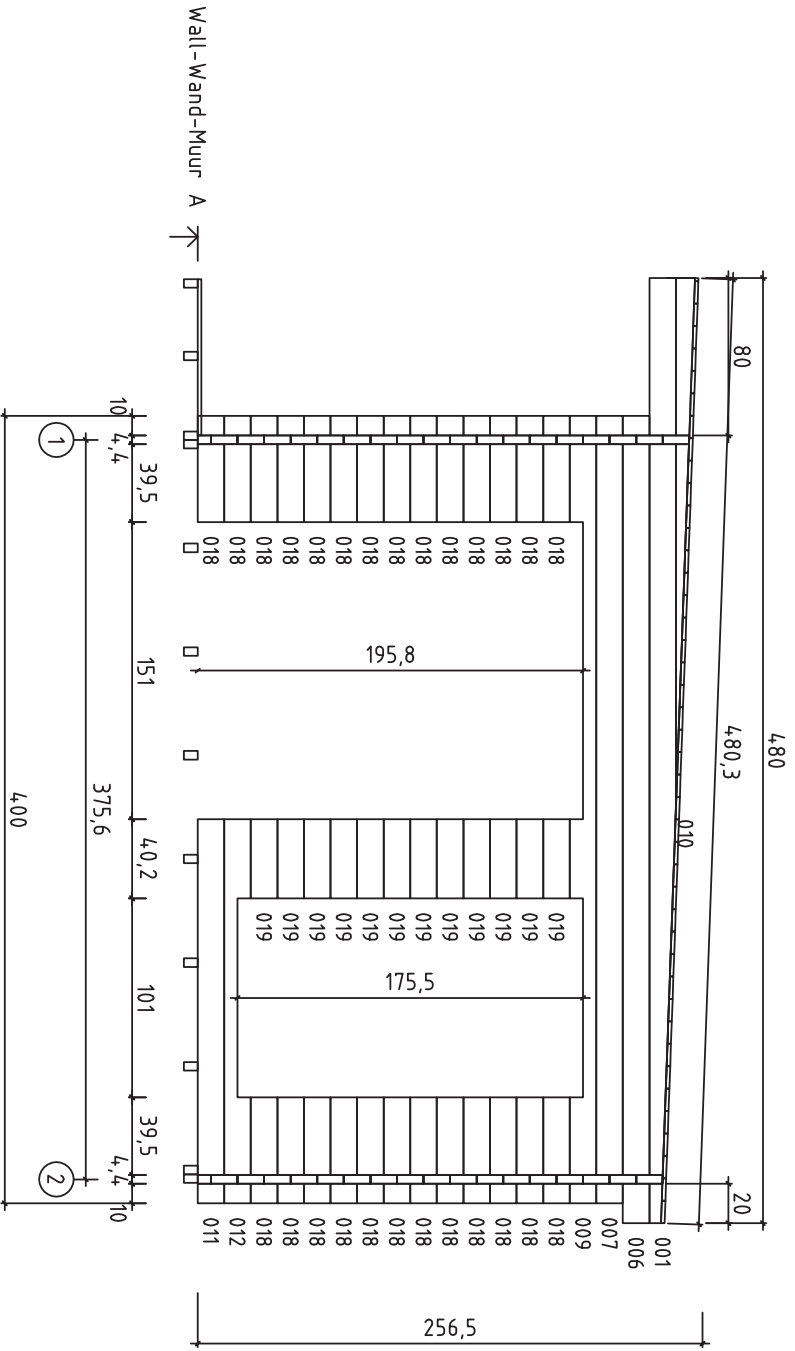

House	Sophia 44	Sheet	5
Drawing	WALL-WAND-MUUR A	Scale	1:35
Material	4.4 x 13.5	Date	21.02.2020
Drawer	K.K.	File	Sophia 44.dwg

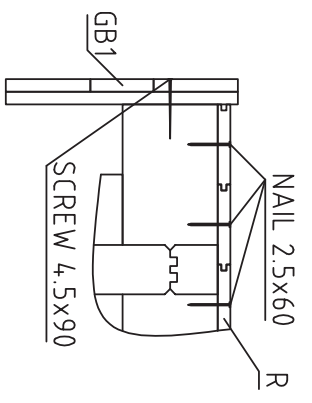
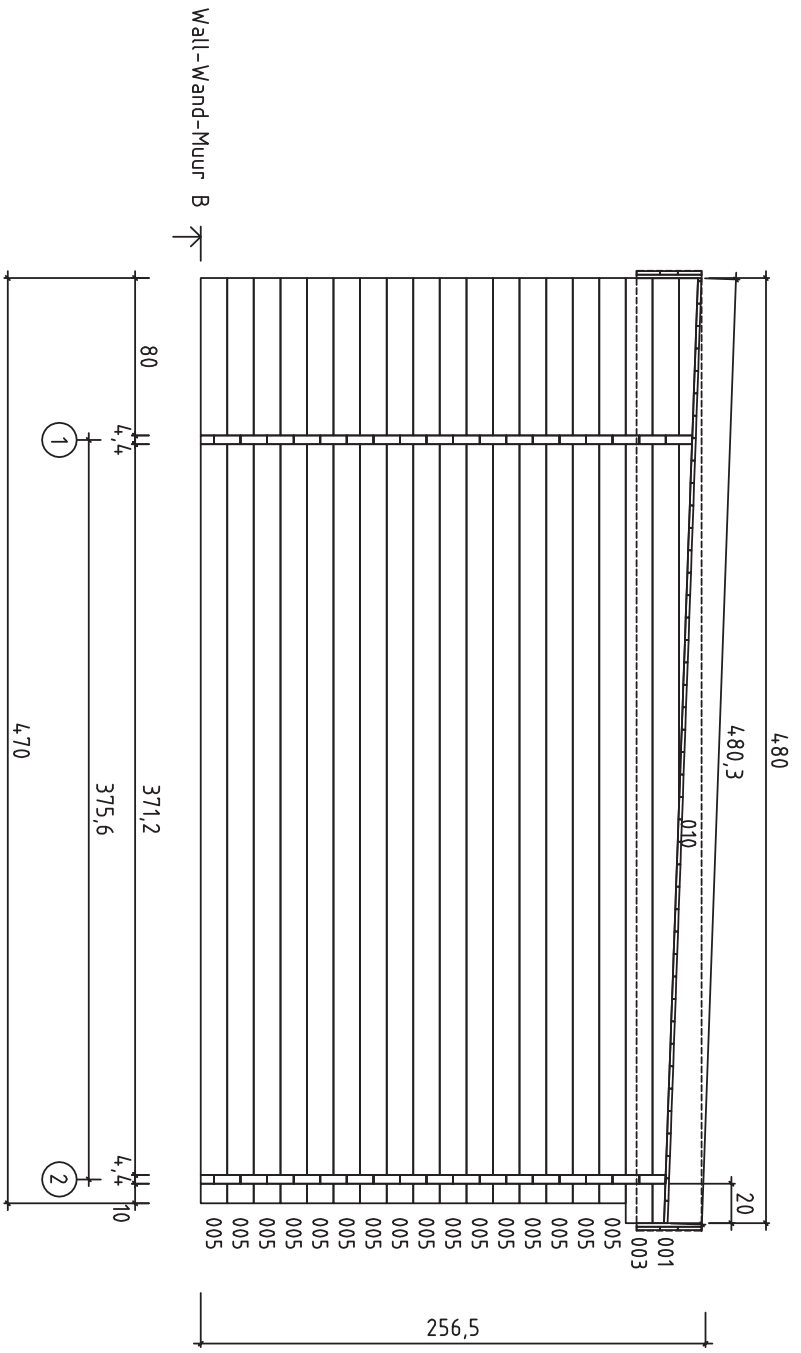

House	Sophia 4,4	Sheet	6
Drawing	WALL-WAND-MUUR B	Scale	1:35
Material	4,4 x 13,5	Date	21.02.2020
Drawer	K.K.	File	Sophia 4,4.dwg

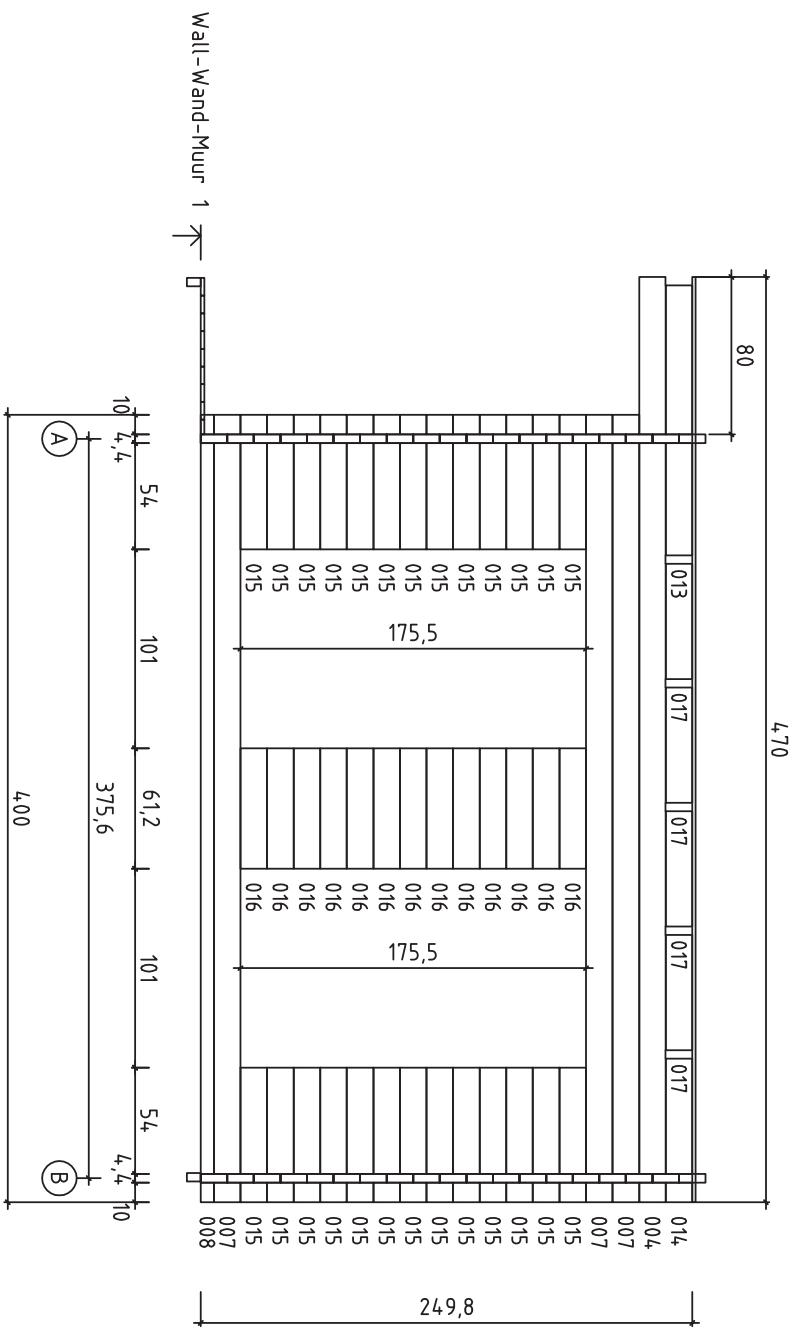



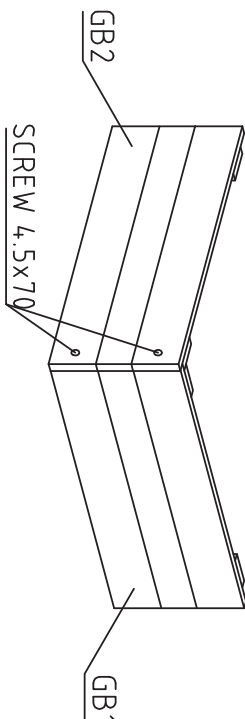
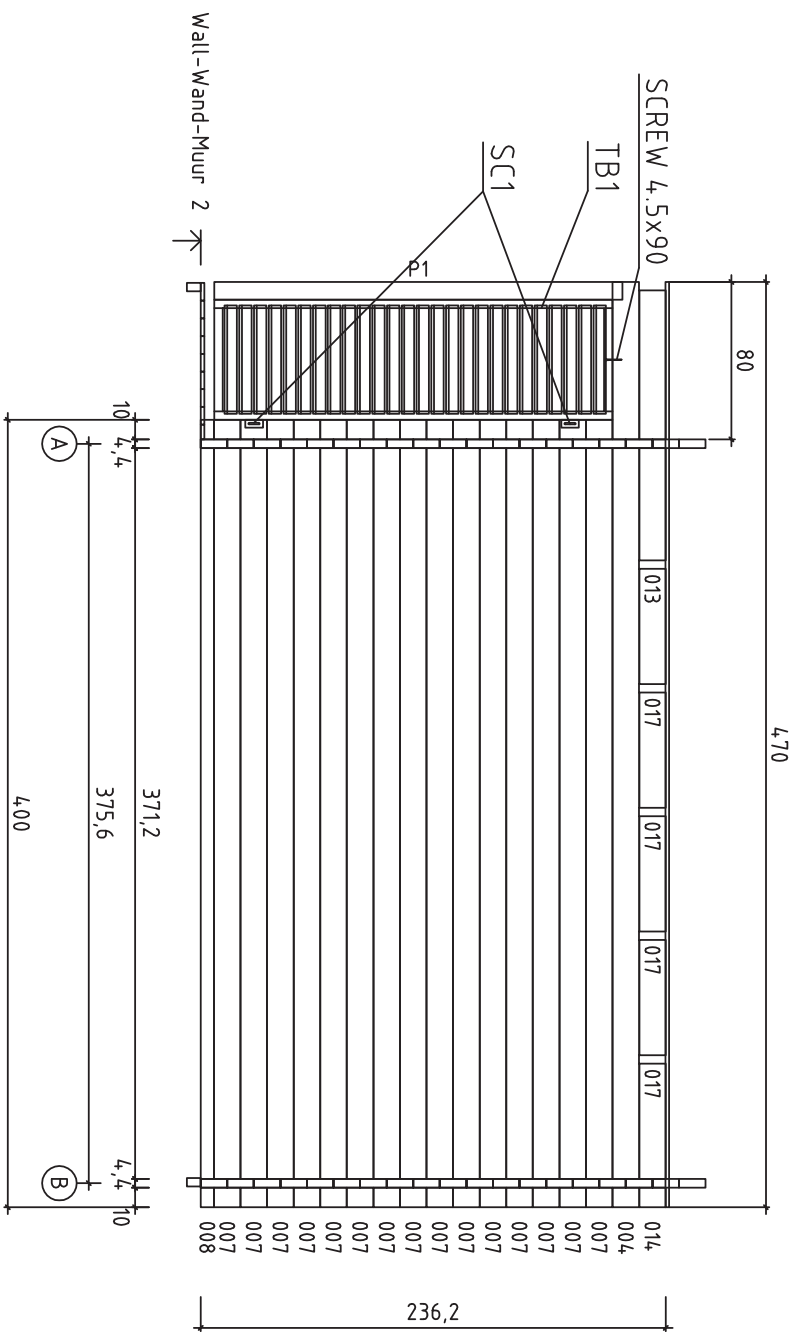



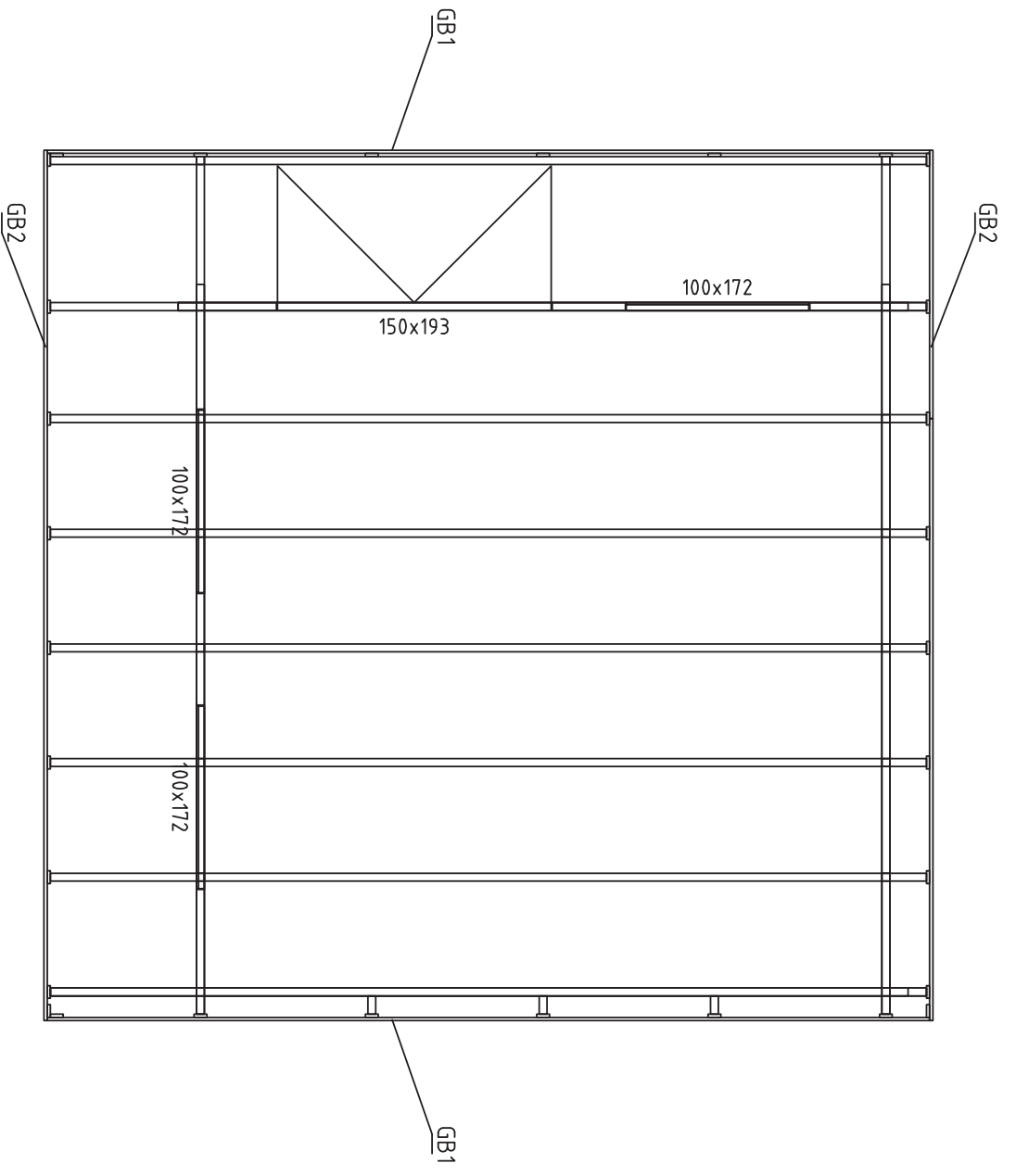

House	Sophia 4.4	Sheet	7
Drawing	WALL-WAND-MUUR 1	Scale	1:35
Material	4.4 x 13.5	Date	21.02.2020
Drawer	K.K.	File	Sophia 4.4.dwg

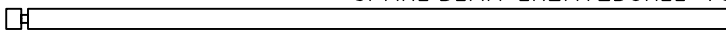
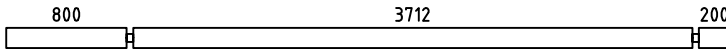

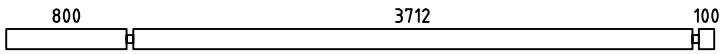
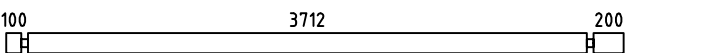
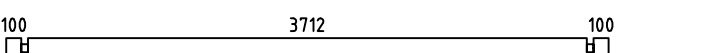
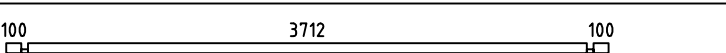
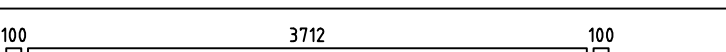
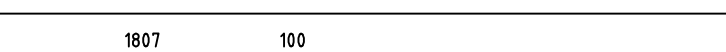
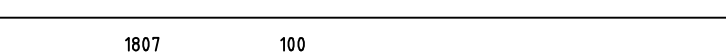
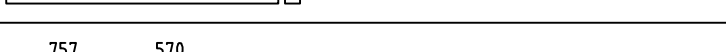
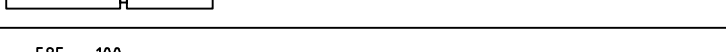
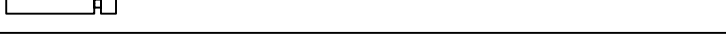
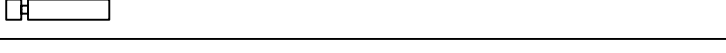
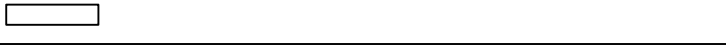
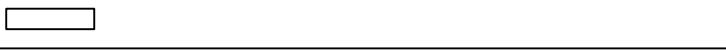

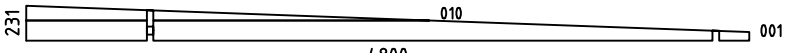
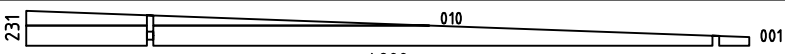

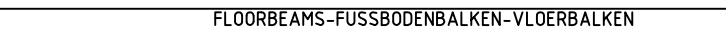
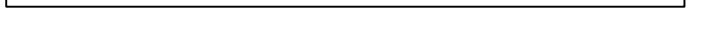
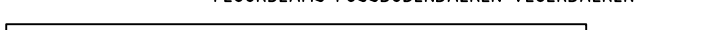



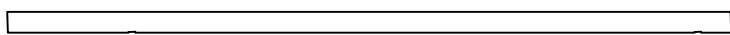





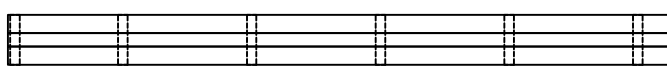





House	Sophia 4.4	Sheet	8
Drawing	WALL-WAND-MUUR 2	Scale	1:35
Material	4.4 x 13.5	Date	21.02.2020
Drawer	K.K.	File	Sophia 4.4.dwg



House	Sabrina - 44	Sheet	9
Drawing	Plan	Scale	1:35
Material		Date	21.02.2020
Drawer	K.K.	File	Sabrina - 44.dwg

Pos	Specification-Bestimmung-Omschrijving Sophia 44	Pcs	Profile (mm)	L (mm)		
002	SPARE BEAM-ERZATZBOHLE-VOORRAADPLANK 	1	44x135	4800		
003		1	44x135	4800		
004		2	44x135	4700		
005		16	44x135	4700		
006		1	44x135	4100		
007		19	44x135	4000		
008		2	44x68	4000		
009		1	44x135	4000		
011		1	44x135	1951		
012		1	44x135	1951		
013		2	44x135	1371		
014		2	44x135	729		
015		26	44x135	684		
016		13	44x135	612		
017		8	44x135	585		
018		26	44x135	539		
019		12	44x135	402		
HB	HIT BLOCK-SCHLAGHÖLZER-BLAZENPLANK 	2	44x135	300		
WA-1		1	44x231	4800		
WB-1		1	44x231	4800		
FBI1	FLOORBEAMS-FUSSBODENBALKEN-VLOERBALKEN  IMM	2	43x70	4590		
FBI3	FLOORBEAMS-FUSSBODENBALKEN-VLOERBALKEN  IMM	10	43x70	4505		
FBI4	FLOORBEAMS-FUSSBODENBALKEN-VLOERBALKEN  IMM	2	43x70	3850		
FBI2	FLOORBEAMS-FUSSBODENBALKEN-VLOERBALKEN  IMM	4	43x70	484		
P1	POST-POST-POST 	1	90x90	2070		
Kood	Sophia 44	Materjal	File	Sophia 44.dwg	Leht	10

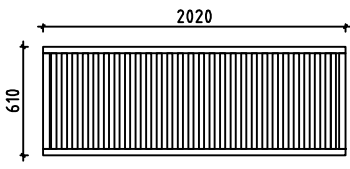
Pos	Specification-Bestimmung-Omschrijving Sophia 44	Pcs	Profile (mm)	L (mm)
KT1	ASSEMBLING BOARD-MONTAGE BOARD-MONTAGE PLANK 	3	45x90	100
RB1	ROOFBEAMS-DACHBALKEN-DAKBALK 	6	43x140	4800
F1	FLOORBOARD-FUSSBODENBRETT-VLOERPLANK  or-oder-of	43+1 33+1	18x88 18x114	3710
T1	TERRACE BOARD-TERRASSENBRETT-TERRASSPLANK  IMM	9+1	90x19	4595
T2	TERRACE BOARD-TERRASSENBRETT-TERRASSPLANK  IMM	42	90x19	795
R1	ROOFBOARD-DACHBRETT-DAKPLANK  or-oder-of	56+1 43+1	18x88 18x114	4700
FF1	FLOOR FILLET-FUSSBODENLEISTE-VLOERPLINT 		18x35	15.0
GB1		2	36x330	4836
GB2		2	36x330	4770
SS1 SS2	STORM SLAT-STURMLEISTE-STORMLIJST 	2 2	18x35	2250 2350
PR	POST REGULATOR-PFOSTEN REGLER-STUT REGELAAR 	1		
SC1	STEEL CORNER-STAHL ECKE-STALEN HOEK 	2	35x130	35
	SCREWS-SCHRAUBEN-SCHROEF FOR-FÜR-VOOR SC1 	2	∅6.0	40
	NAIL-NAGEL-NAGEL FOR-FÜR-VOOR FF1 	20	∅2.0	40
	NAIL-NAGEL-NAGEL FOR-FÜR-VOOR F1, R1, T1, T2 	1015	∅2.5	60
	SCREWS-SCHRAUBEN-SCHROEF FOR-FÜR-VOOR SC1 	4	∅3.5	35
	SCREWS-SCHRAUBEN-SCHROEF FOR-FÜR-VOOR SS1 	12	∅6.0	50
	WASHER-SCHEIBE-SCHIJF FOR-FÜR-VOOR SC1, SS1 	14	∅6.0	18
	SCREWS-SCHRAUBEN-SCHROEF FOR-FÜR-VOOR GB1, GB2 	17	∅4.5	70
	SCREWS-SCHRAUBEN-SCHROEF FOR-FÜR-VOOR TB1, TB2, GB1, GB2 008 	48	∅4.5	90
	SCREWS-SCHRAUBEN-SCHROEF FOR-FÜR-VOOR FBI1, FBI2, FBI3, FBI4 	30	∅5.0	120
	SCREWS-SCHRAUBEN-SCHROEF FOR-FÜR-VOOR RB1 	12	∅6.0	160
TB1		1	70x610	2020
Kood	Sophia 44	Materjal	File Sophia 44.dwg	Leht 11

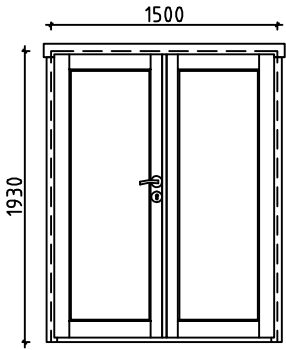
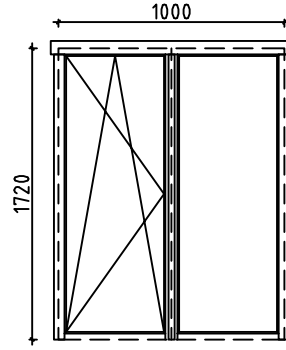
Pos	Specification-Bestimmung-Omschrijving Sophia 44	Pcs	Profile (mm)	L (mm)
	<p>DOUBLEDOOR-DOPPELTÜR-DUBBELE DEUR (left-links-links) AST_PRE</p>  <p>WINDOW-FENSTER-VENSTER (closed-feststehend-gesloten) AST_ISO_K 1P 2V</p> 	<p>V</p> <p>2</p> <p>2</p> <p>2</p> <p>12</p> <p>3</p> <p>6</p> <p>12</p>	<p>1500</p> <p>1000</p>	<p>1930</p> <p>1720</p>
Kood Sophia 44	Materjal	File Sophia 44.dwg	Leht 12	