

Date rev. Description

V 1.0

House	4464881 Yvonne 44	Sheet	1
-------	-------------------	-------	---

Drawing	3D	Scale	
---------	----	-------	--

Material	44x135	Date	15.02.2023
----------	--------	------	------------

Drawer	K.K.	File	4464881 Yvonne 44_3D.dwg
--------	------	------	--------------------------

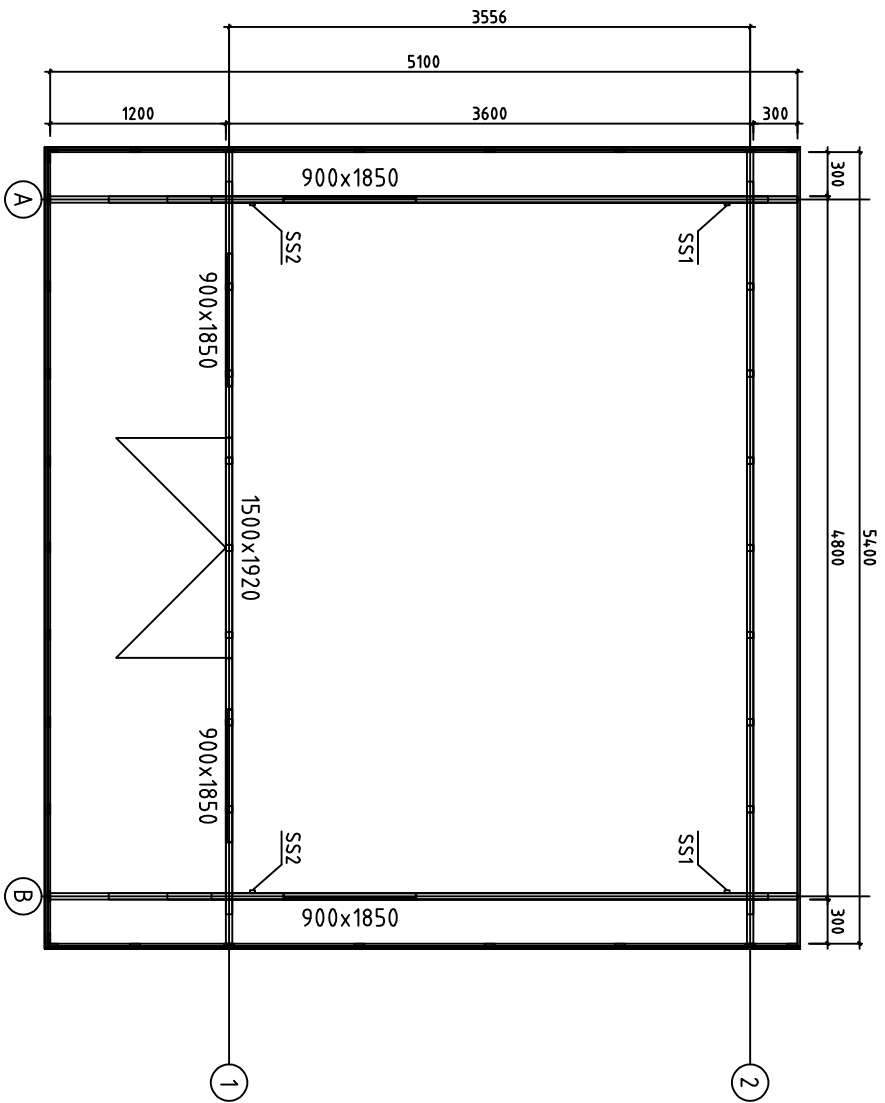

Kood	4464881 Yvonne 44	Leht	2
Joonis	Plan	Mootkava	1:50
Materjal	44x135	Kuup.	15.02.2023
Jonestas	K.K.	File	4464881 Yvonne 44.dwg

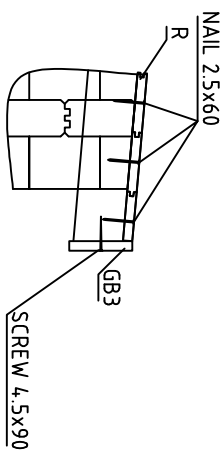
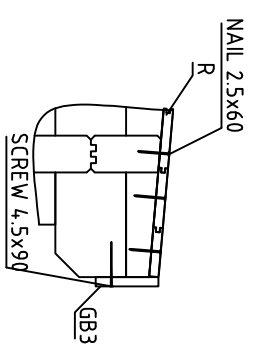
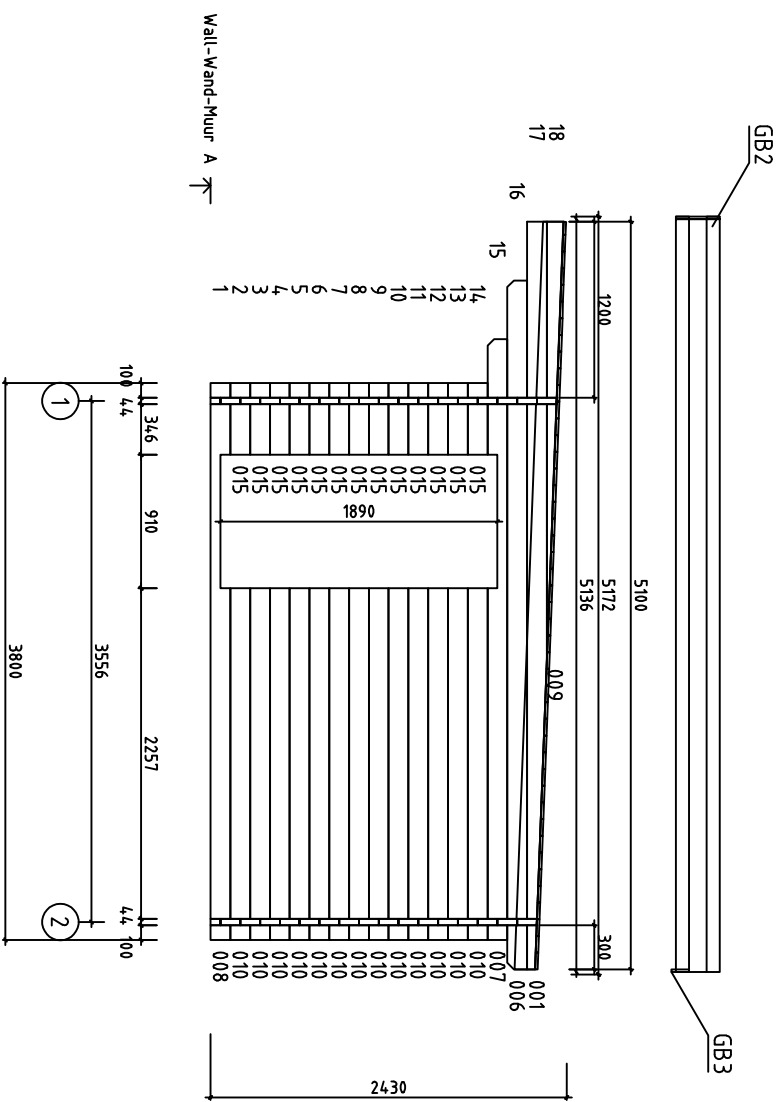

Kood	4464881 Yvonne 4.4	Leht	3
Joonis	WALL - WAND - MUUR A	Mootkava	1:50
Materjal	4.4x13.5	Kuup.	15.02.2023
Joonestaj	K.K.	File	4464881 Yvonne 4.4.dwg

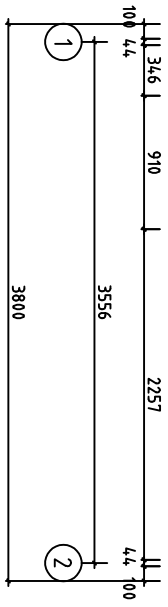
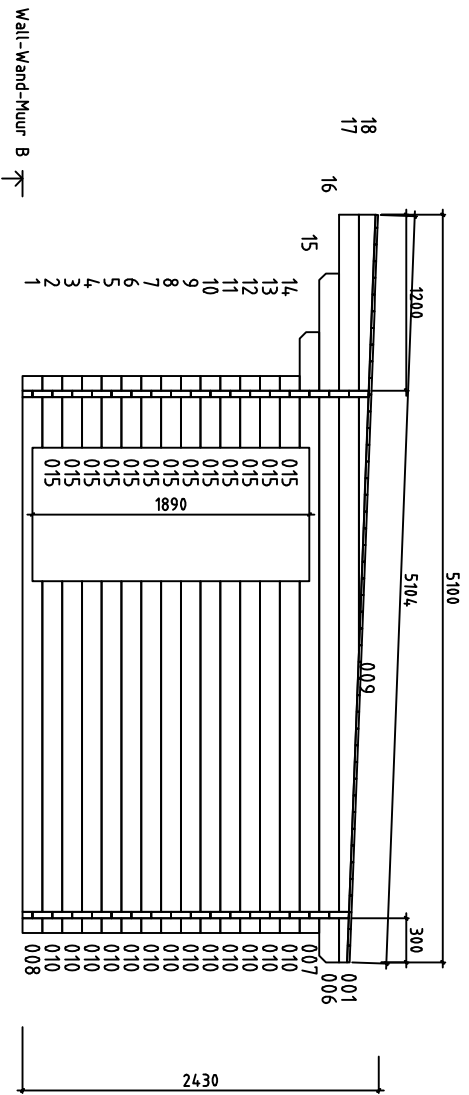

Kood	4464881 Yvonne 44	Leht	4
Joonis	WALL - WAND - MUUR B	Mootkava	1:50
Materjal	4.4x13.5	Kuup.	15.02.2023
Joonestaj	K.K.	File	4464881 Yvonne 44.dwg

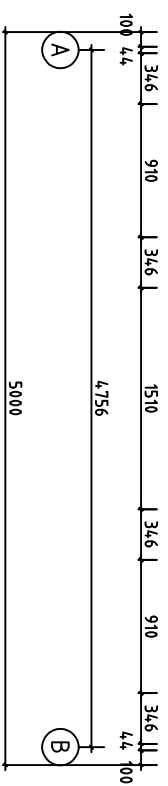
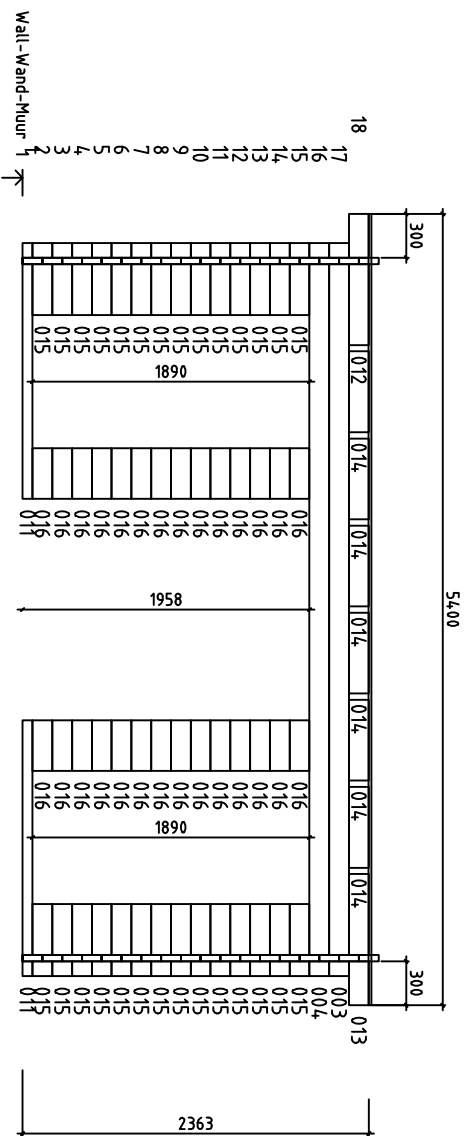
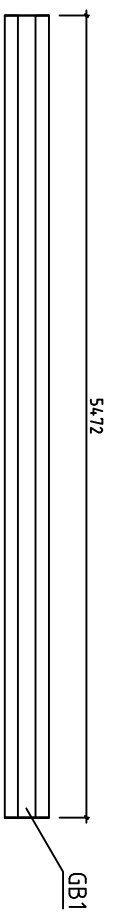



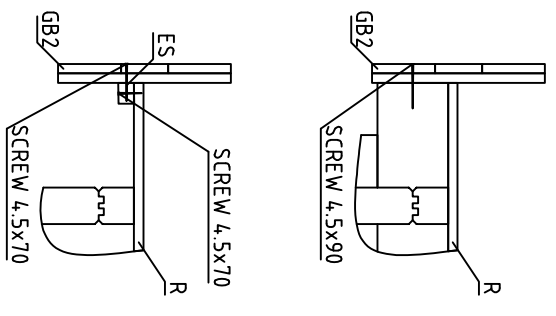



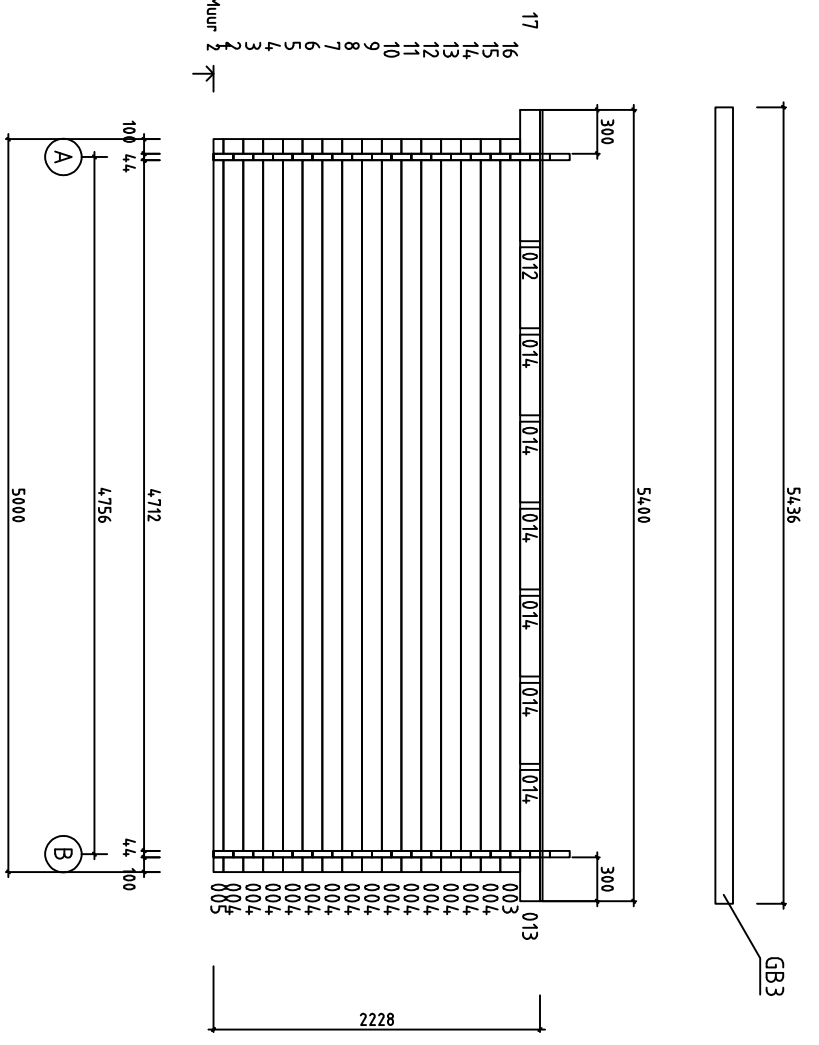

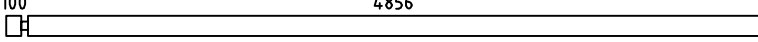
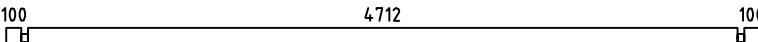
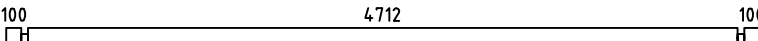
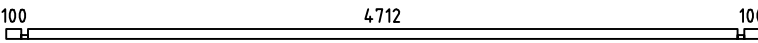
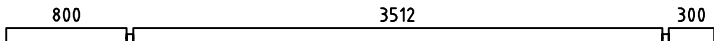
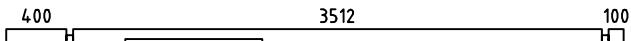
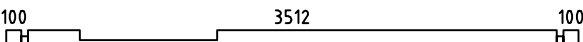
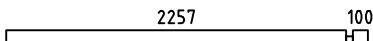
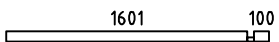
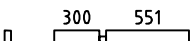
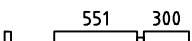
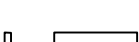

Kood	4464881 Yvonne 44	Leht	5
Joonis	WALL-WAND-MUUR 1	Mootkava	1:50
Materjal	4.4x13.5	Kuup.	15.02.2023
Joonestaj	K.K.	File	4464881 Yvonne 44.dwg



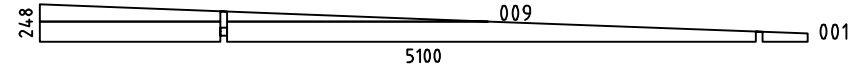
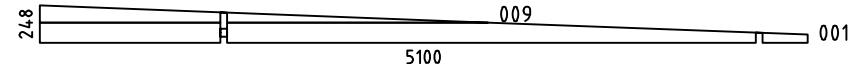
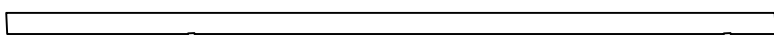



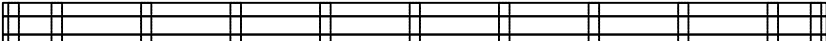
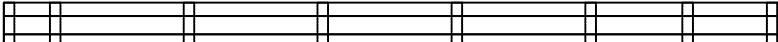





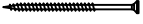
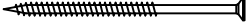

Wall-Wand-Muur

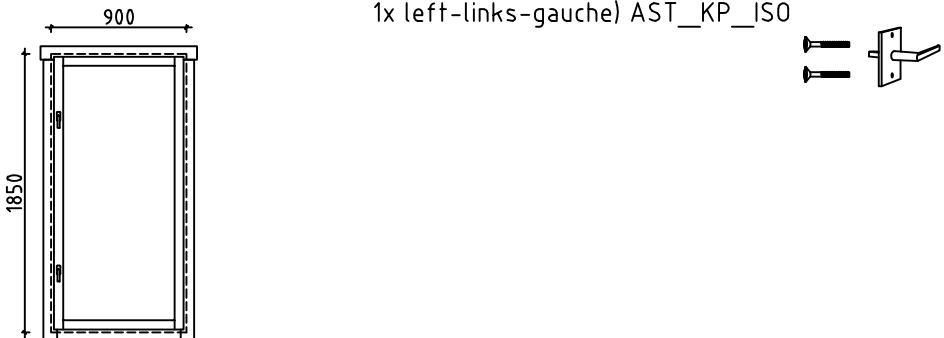
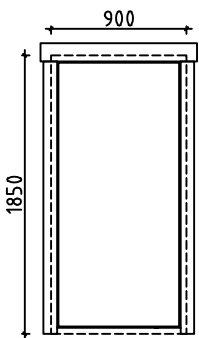

Kood	4464881 Yvonne 44	Leht	6
Joonis	WALL - WAND - MUUR 2	Mootkava	1:50
Materjal	4,4x13,5	Kuup.	15.02.2023
Joonestaj	K.K.	File	4464881 Yvonne 44.dwg

Pos	Specification-Bestimmung-Omschrijving	Pcs	Profile (mm)	L (mm)		
002	SPARE BEAM-ERZATZBOHLE-VOORRAADPLANK 	1	44x135	5000		
003		PM	2	44x135	5000	
004		15	44x135	5000		
005		1	44x68	5000		
006		2	44x135	4700		
007		2	44x135	4100		
008		2	44x135	3800		
010		26	44x135	2400		
011		2	44x68	1745		
012		2	44x135	895		
013		2	44x135	895		
014		12	44x135	551		
015		54	44x135	490		
016		28	44x135	345		
HB	HIT BLOCK-SCHLAGHÖLZER-BLAZENPLANK 	2	44x135	300		
WA-1		1	44x248	5100		
WB-1		1	44x248	5100		
RB1	ROOFBEAMS-DACHBALKEN-DAKBALK 	7	43x140	5110		
R1	ROOFBOARD-DACHBRETT-DAKPLANK  or-oder-of	59+1 45+1	18x88 18x114	5400		
ES1	EAVE SLAT-TRAUFENLEISTE-AFDEKLIJST 	2	30x40	5105		
SS1	STORM SLAT-STURMLEISTE-STORMLIJST 	2	18x35	2160		
SS2	STORM SLAT-STURMLEISTE-STORMLIJST 	2	18x35	2250		
GB1		1	36x300	5472		
GB2		2	36x300	5136		
GB3	GABLE BOARD-GIEBELBLENDE-PLANCHE DE RIVE 	1	18x120	5436		
Kood	4464881 Yvonne 44	Materjal	File	4464881 Yvonne 44.dwg	Leht	7

Pos	Specification-Bestimmung-Omschrijving	Pcs	Profile (mm)	L (mm)		
	SCREWS-SCHRAUBEN-SCHROEF FOR-FÜR-VOOR SS1, SS2 	12	∅6.0	50		
	WASHER-SCHEIBE-SCHIJF FOR-FÜR-VOOR SS1, SS2 	12	∅6.0	18		
	NAIL-NAGEL-NAGEL FOR-FÜR-VOOR R1 	545	∅2.5	60		
	SCREWS-SCHRAUBEN-SCHROEF FOR-FÜR-VOOR GB1, GB2 	235	∅3.5	35		
	SCREWS-SCHRAUBEN-SCHROEF FOR-FÜR-VOOR 2xGB1, 2xGB2 	35	∅4.5	70		
	SCREWS-SCHRAUBEN-SCHROEF FOR-FÜR-VOOR 005, 2x011, GB1, GB2 	37	∅4.5	90		
	SCREWS-SCHRAUBEN-SCHROEF FOR-FÜR-VOOR 2x008, RB1 	39	∅6.0	160		
	DOUBLEDOR-DOPPELTÜR-DUBBELE DEUR (right-rechts-rechts) AST_PL_ISO P 	1	1500	1920		
	WINDOW-FENSTER-FENÊTRE (1x right-rechts-droit 1x left-links-gauche) AST_KP_ISO P+V 	1+1	900	1850		
	WINDOW-FENSTER-VENSTER (closed-feststehend-gesloten) AST_ISO_K 	2	900	1850		
Kood	4464881 Yvonne 44	Materjal	File	4464881 Yvonne 44.dwg	Leht	8

Assembly Instructions-Montageanleitungen-Montage-instructies					
L1	BOARD-BRETT-PLANK		1	18x120	5472
L2	BOARD-BRETT-PLANK		2	18x90	5472
L3	BOARD-BRETT-PLANK		2	18x120	5136
L4	BOARD-BRETT-PLANK		4	18x90	5136
L5	BOARD-BRETT-PLANK		27	18x70	300

GB1 1 36x300 5472

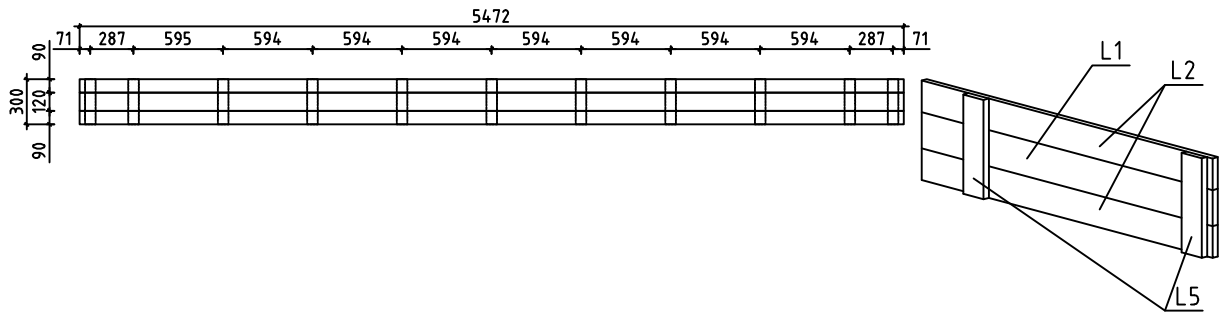

GB2 2 36x300 5136

