

# INSTALLATION VON ABDECKUNG UND ELEKTROSYSTEM.

**ALLE ELEKTRISCHE ARBEITEN SOLLTEN VON ZUGELASSENE SPEZIALIST MONTIERT WERDEN !!!**

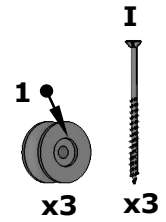

Schrauben sie 6 st. aus.

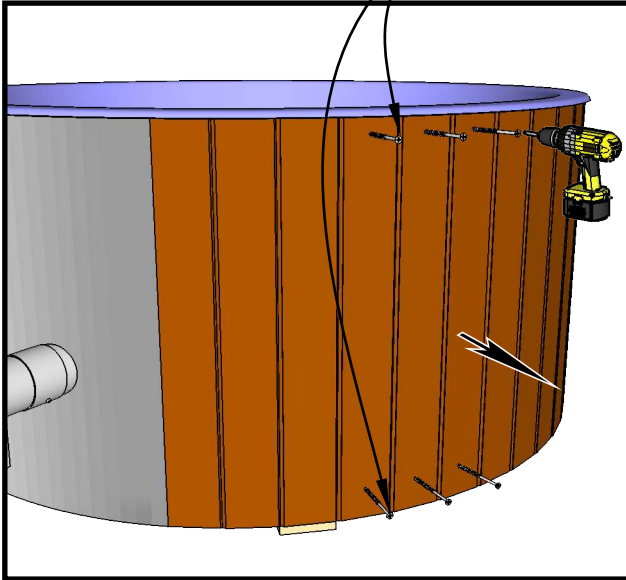

I

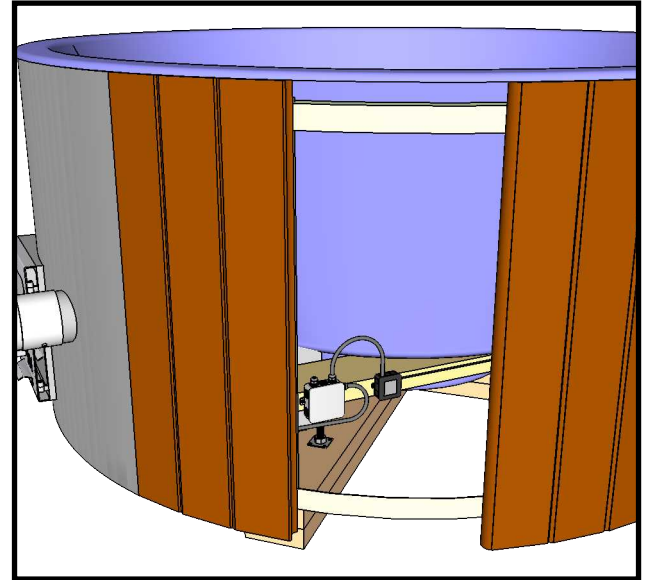

II

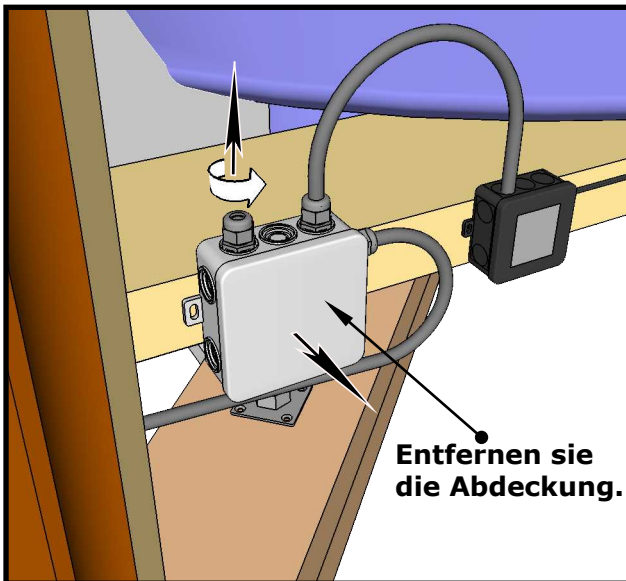

III

Entfernen sie die Abdeckung.

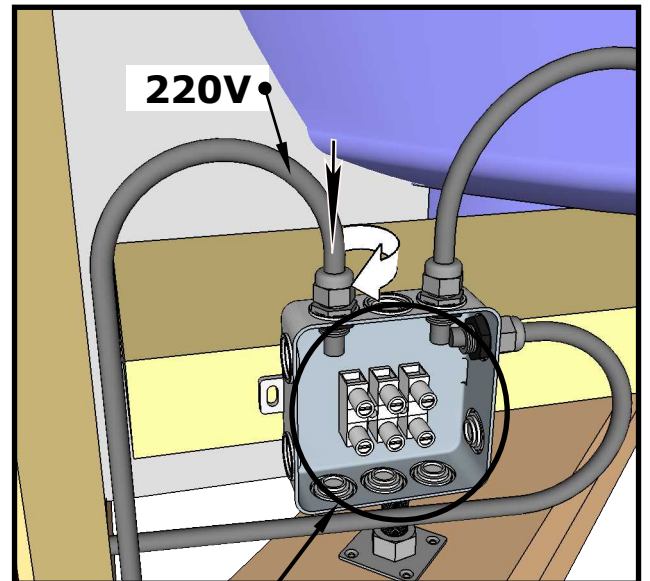

VI

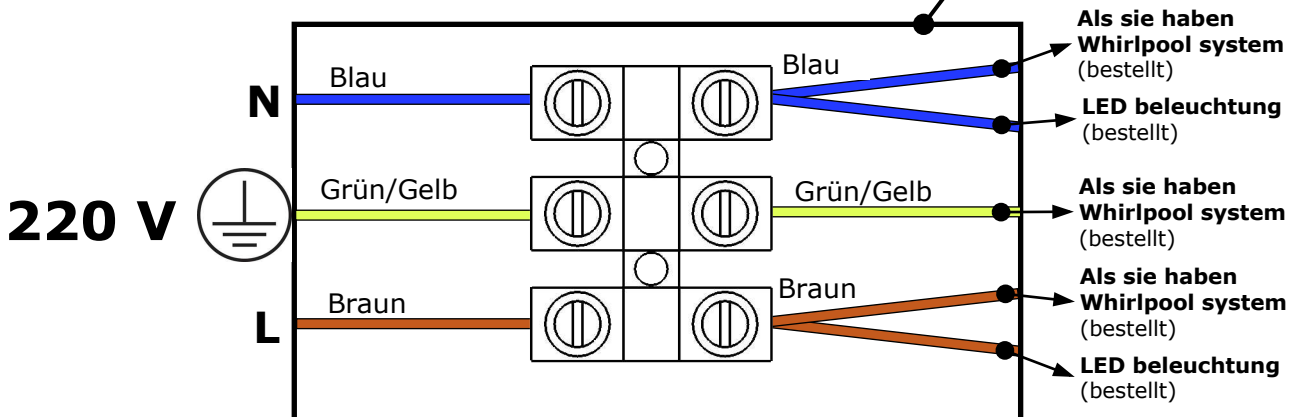

Schrauben sie  
die Bohlen neu.

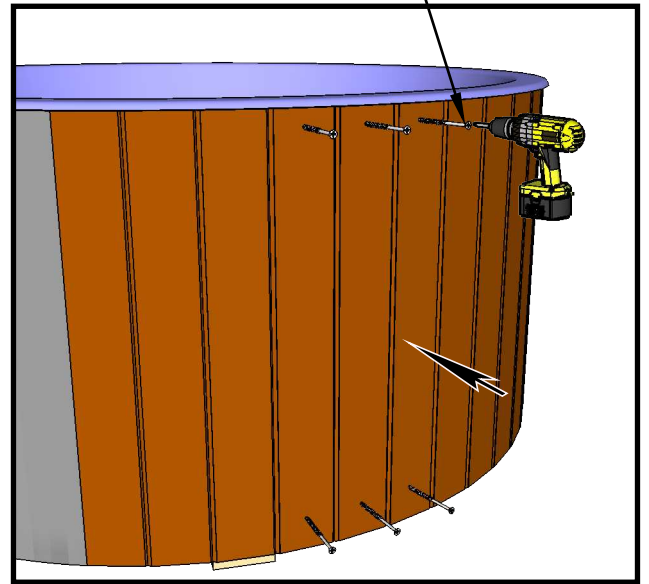
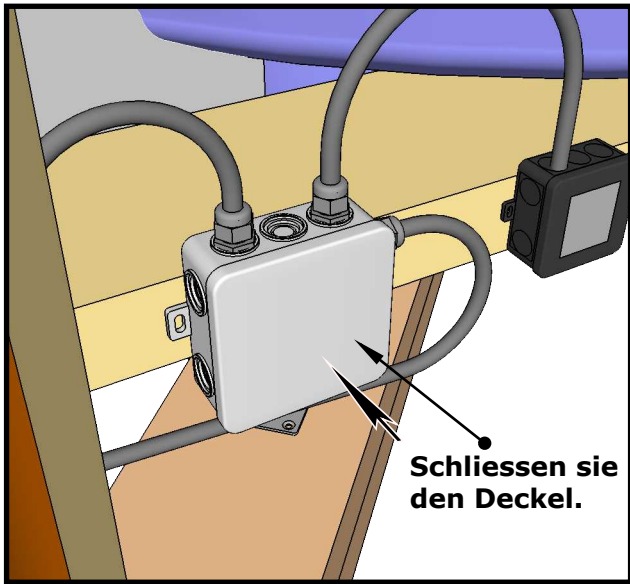

Finde 3  
vorgebohrte Löcher.

