

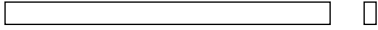

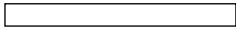

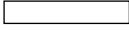







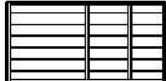
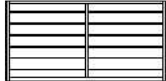
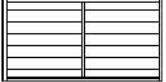
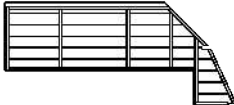
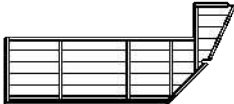

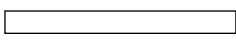
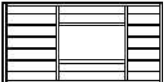

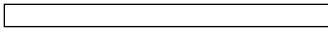

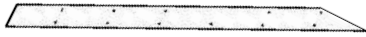

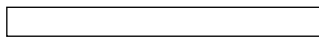
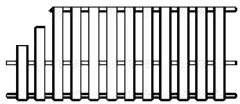
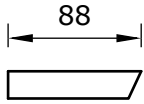
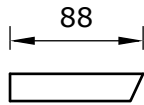
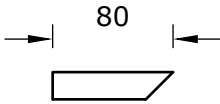
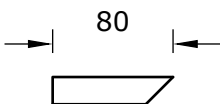
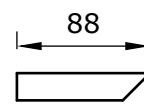
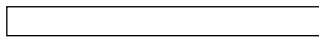

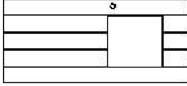
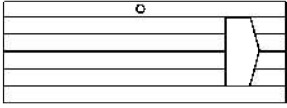
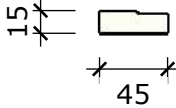
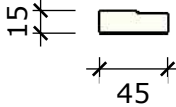
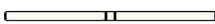

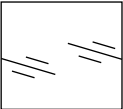
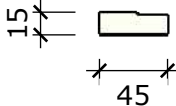
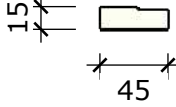
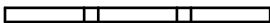

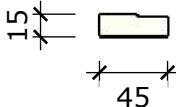
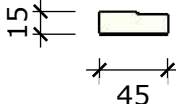
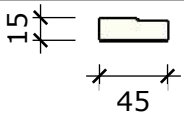
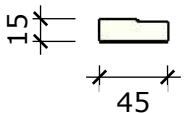
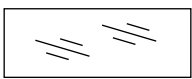
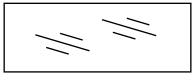
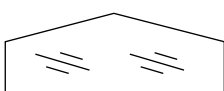
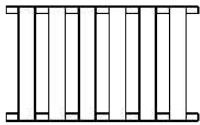
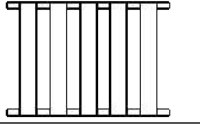



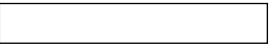

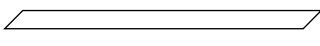
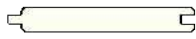
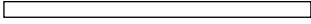

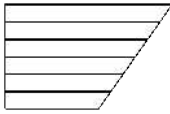
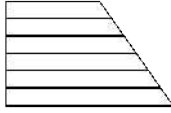
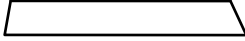
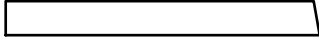

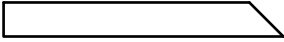
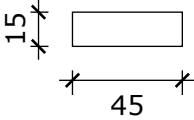

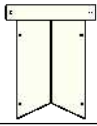
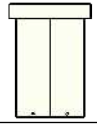

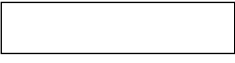
Pos.		pcs	mm.
1		2	28x40x2002
2		16	28x40x1161
3		8	28x40x400
4		21	16x114x2002
5		1	44x1017x2292
6		1	44x1017x2292
7		1	44x789x1587
8		1	44x800x1587
9		1	44x789x1587
10		1	44x1017x2292
11		1	44x1017x2292
12		1	28x58x675
13		1	28x28x675
14		1	44x789x1587

Pos.		pcs	mm.
15		1	44x800x1587
16		1	44x789x1587
17		3	28x58x2000
18		18	16x114x733
19		2	28x90x1438
20		6	28x90x400
21		1	28x58x845
22		1	42x625x1518
23		4	18x88x1800; 25*
24		4	18x88x870; 25*
25		2	18x80x1800; 45*
26		2	18x80x870; 45*
27		4	18x88x1335; 45*
28		2	28x40x802

Pos.		pcs	mm.
29		24	18x90x802
30		1	44x550x1220
31		1	44x665x1860
32		6	15x45x421
33		2	15x45x360
34		1	15x17x444
35		5	15x17x415
36		1	1,5x370x397
37		6	15x45x644
38		4	15x45x537
39		4	15x17x728
40		2	15x17x531
41		2	15x45x278; 15*
42		2	15x45x278; 15*

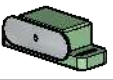
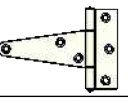
Pos.		pcs	mm.
43		2	15x45x160; 15*
44		2	15x45x160; 15*
45		2	1,5x357x680
46		1	1,5x484x680
47		2	1,5x484x260
48		2	42x450x762
49		2	42x450x644
50		4	40x68x1245
51		4	40x68x1335; 10*
52		2	14x66x644
53		2	14x66x762
54		48	16x114x630
55		48	16x114x800
56		2	28x40x733;5*+10*

Pos.		pcs	mm.
57		24	16x114x900
58		2	28x28x730
59		1	44x602x1203
60		1	31x880x1284
61		1	31x880x1284
62		4	18x90x639; 10*+25*
63		2	18x90x830;10*
64		2	18x90x825; 10*+35*
65		2	18x90x930
66		2	18x90x900; 45*
67		4	15x45x640
68		2	15x45x830
69		2	15x45x820
70		2	15x45x775
71		2	15x45x900
72		8	15x45x1500

Pos.			pcs	mm.
73			2	44x236x300
74			2	44x216x300
75			6	18x90x180
76			6	18x90x385
77			3	18x90x500
K1	4,0x50		184	
K2	4,0x60		20	
K3	2,1x40		534	
K4	5,0x70		42	
K5	3,5x30		186	
K6	3,5x25		86	
K7			3	
K8			5	
K9			14	
K10	5,0x120		4	
K11	3,5x40		151	

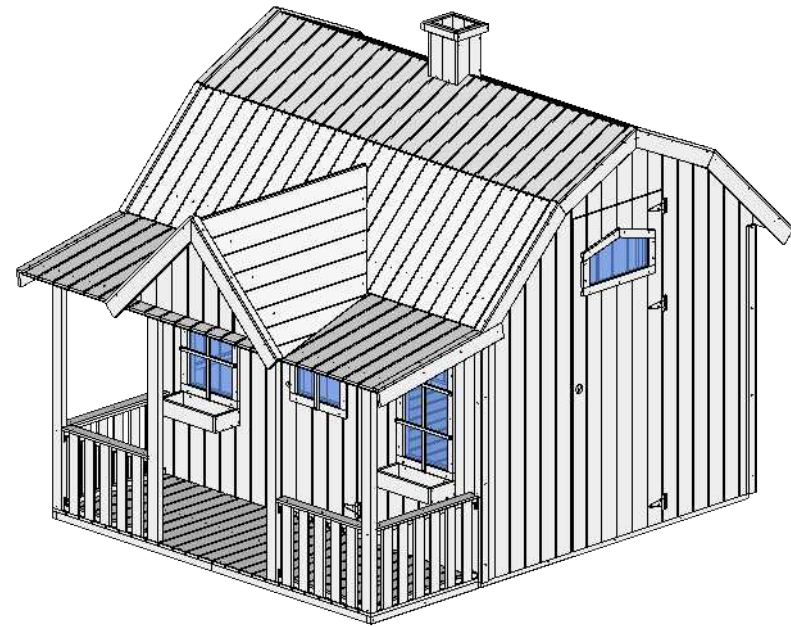
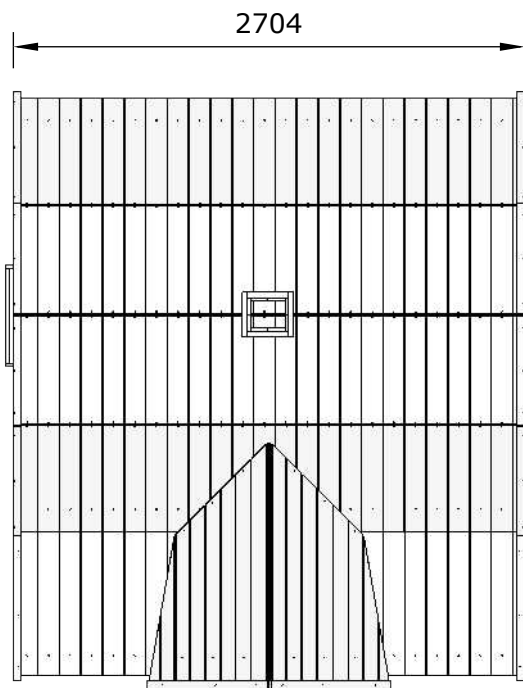
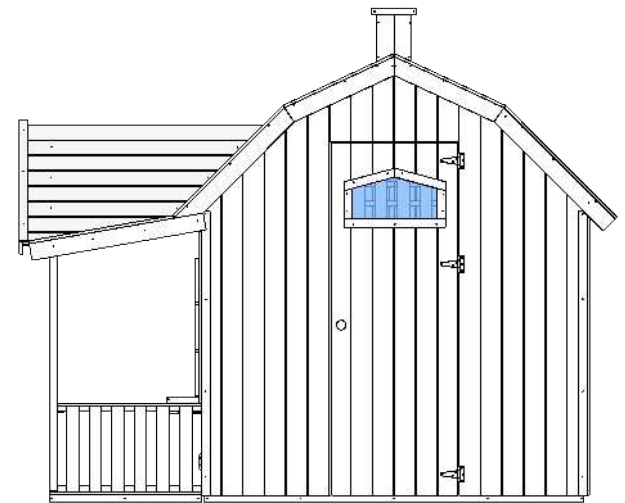
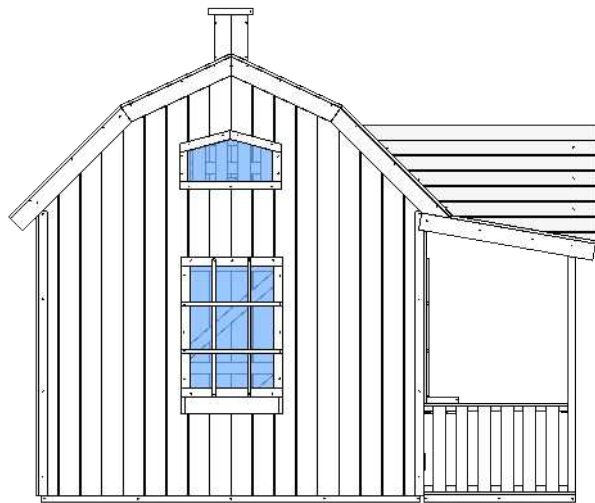

Serial no. _____

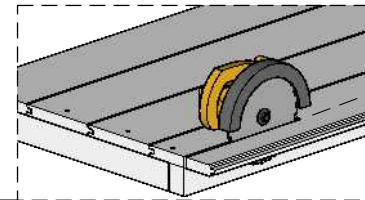
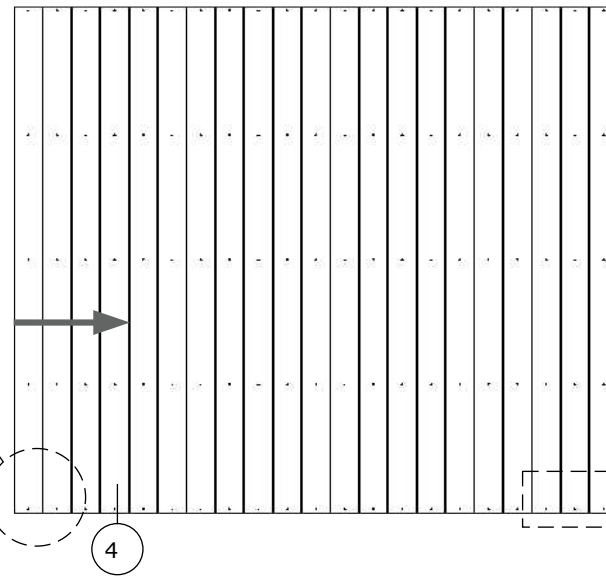
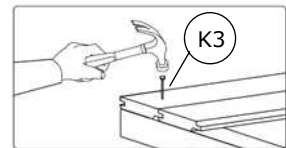
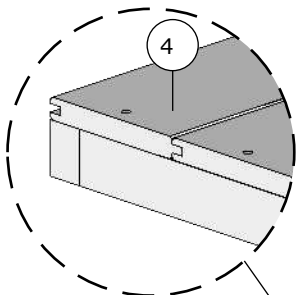
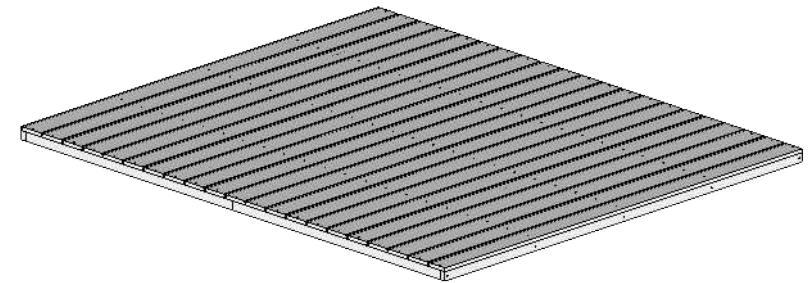
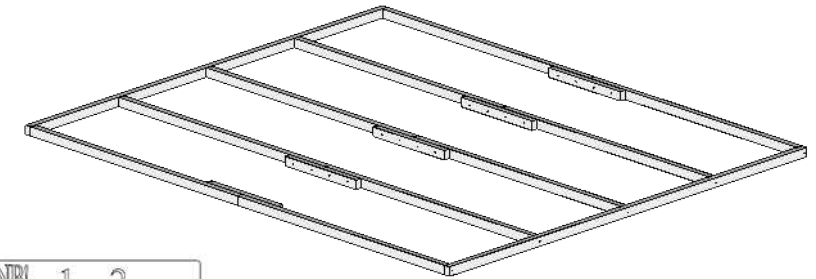
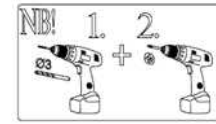
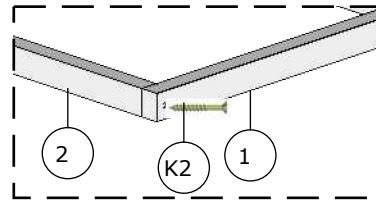
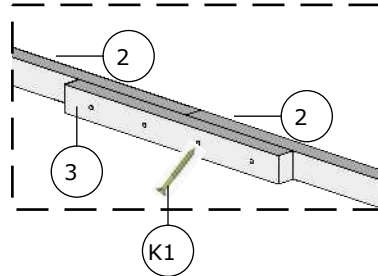
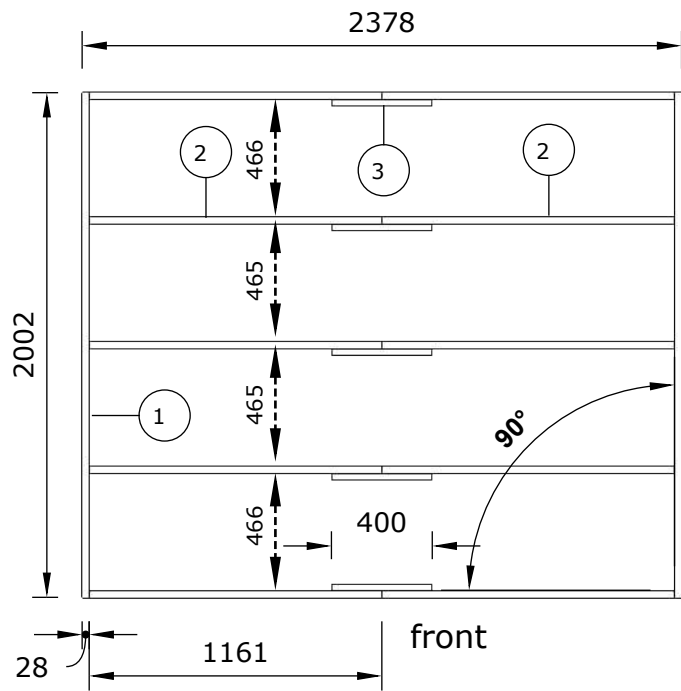

1	28x40x2002	2
2	28x40x1161	10
3	28x40x400	5
4	16x114x2002	21
K1	4,0x50	20
K2	4,0x60	10
K3	2,1x40	120

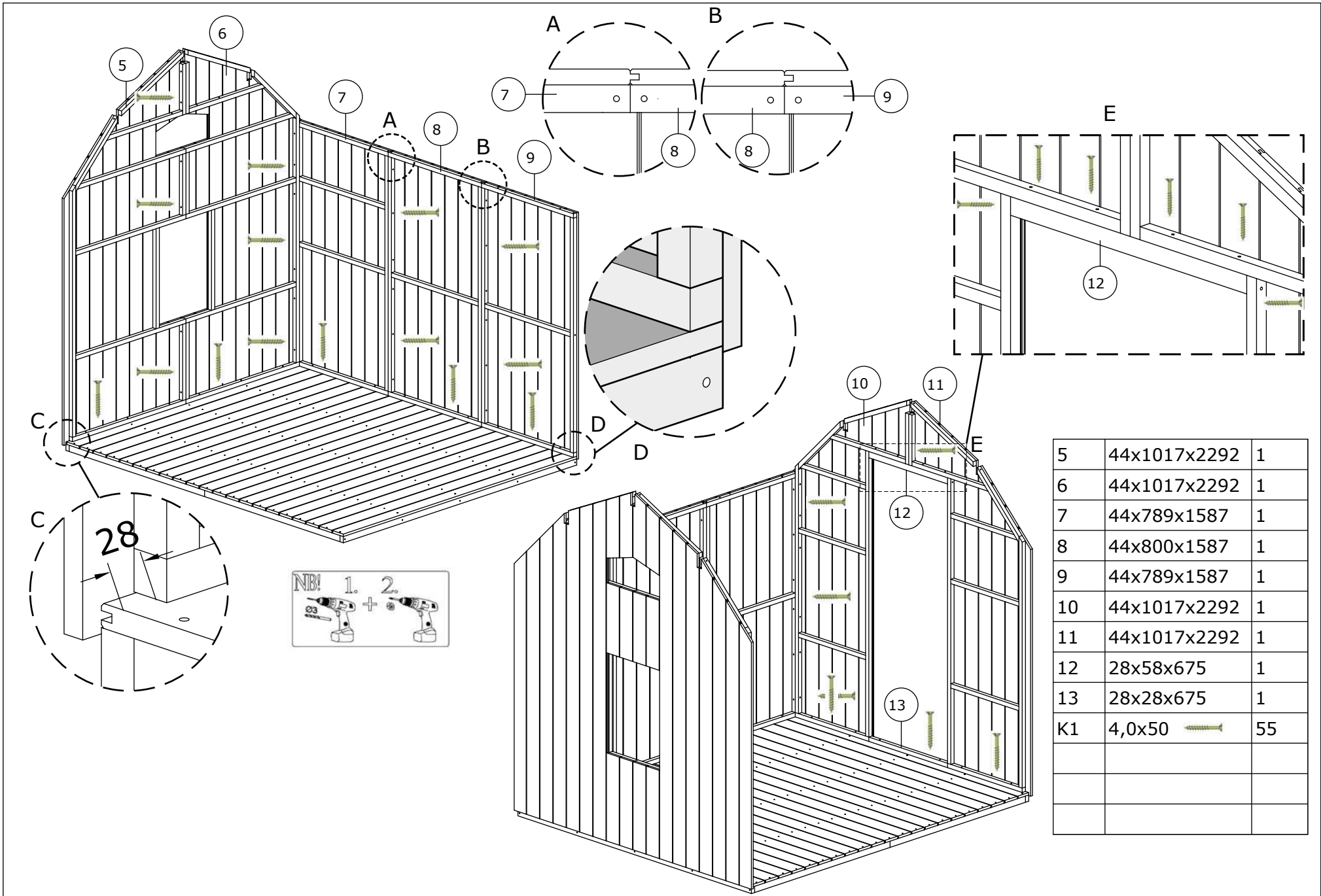

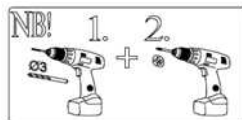
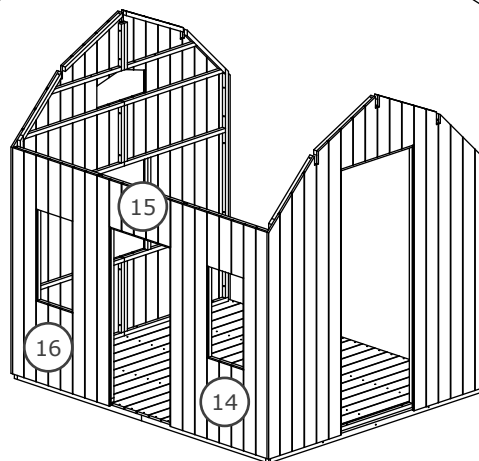
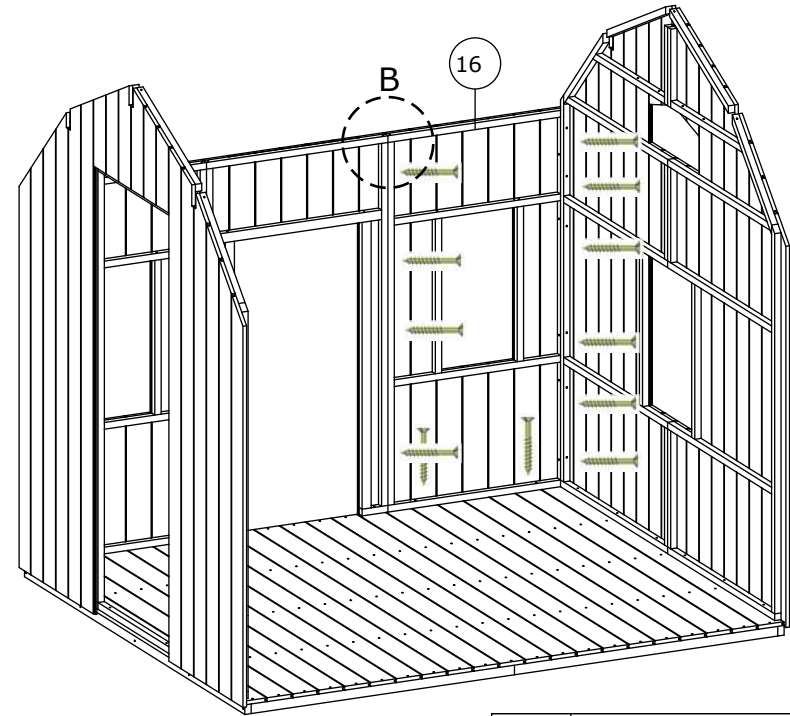
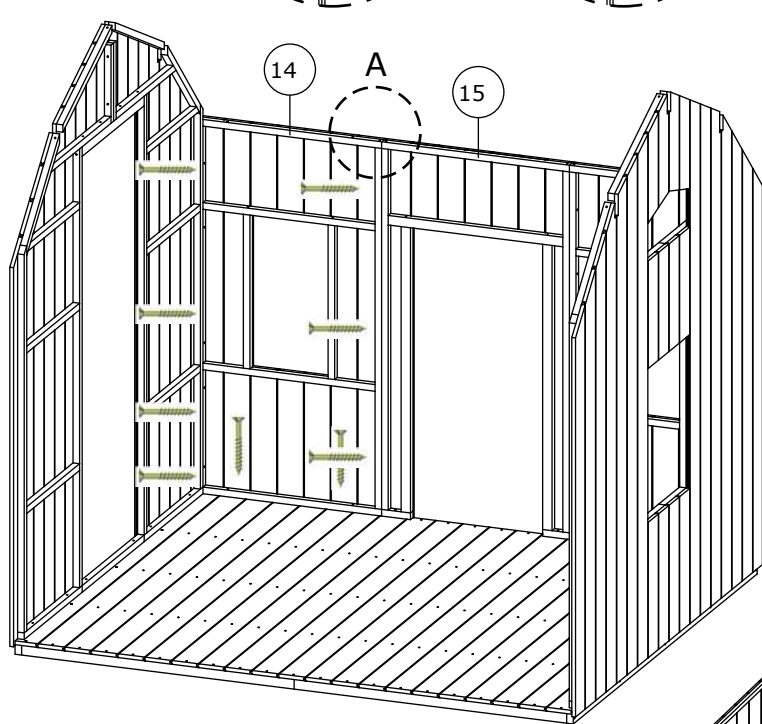
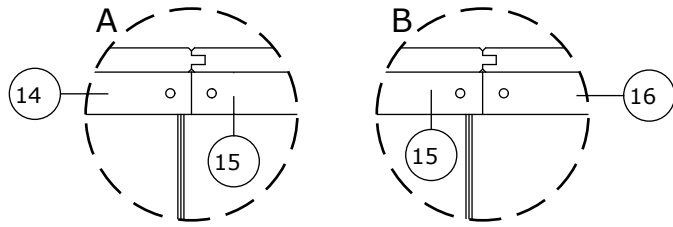

5	44x1017x2292	1
6	44x1017x2292	1
7	44x789x1587	1
8	44x800x1587	1
9	44x789x1587	1
10	44x1017x2292	1
11	44x1017x2292	1
12	28x58x675	1
13	28x28x675	1
K1	4,0x50 	55

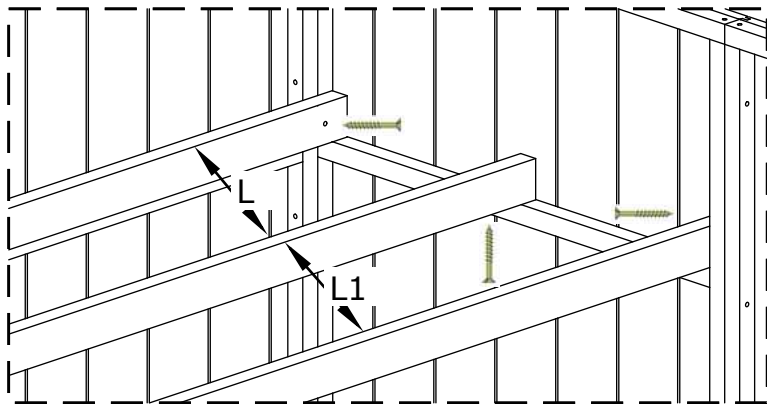
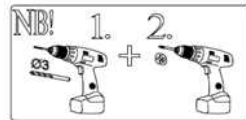
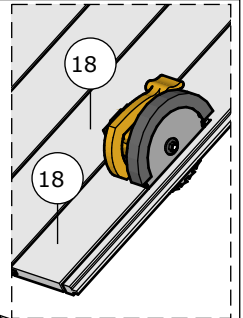
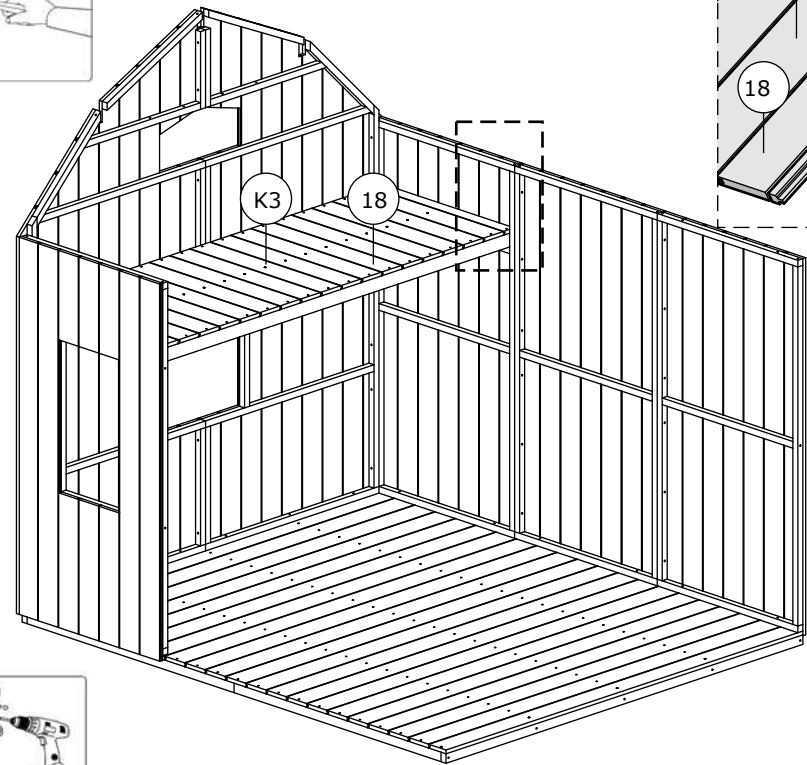
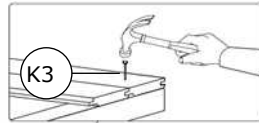
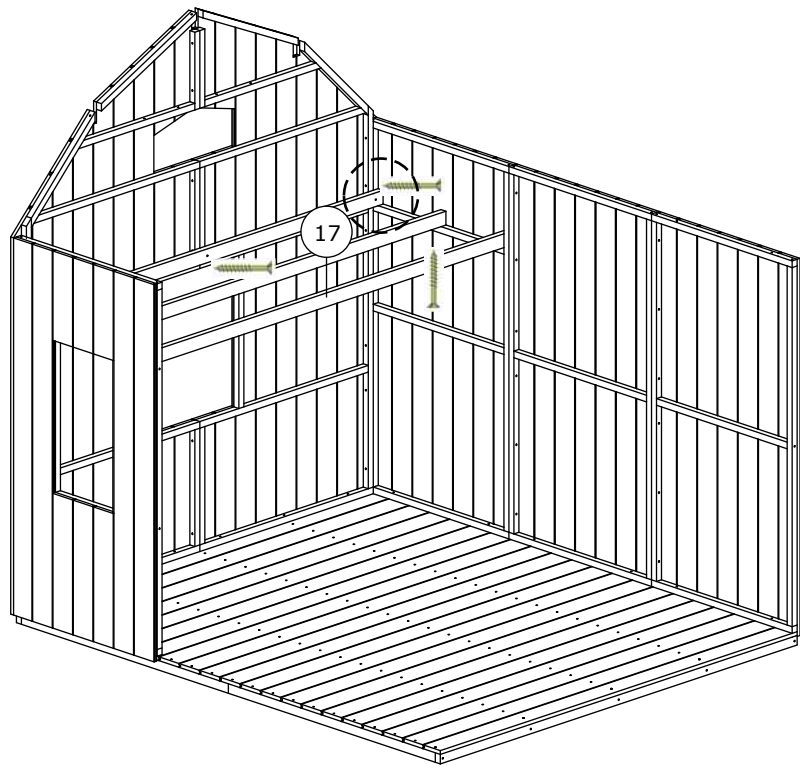

14	44x789x1587	1
15	44x800x1587	1
16	44x789x1587	1
K1	4,0x50	24



L=L1



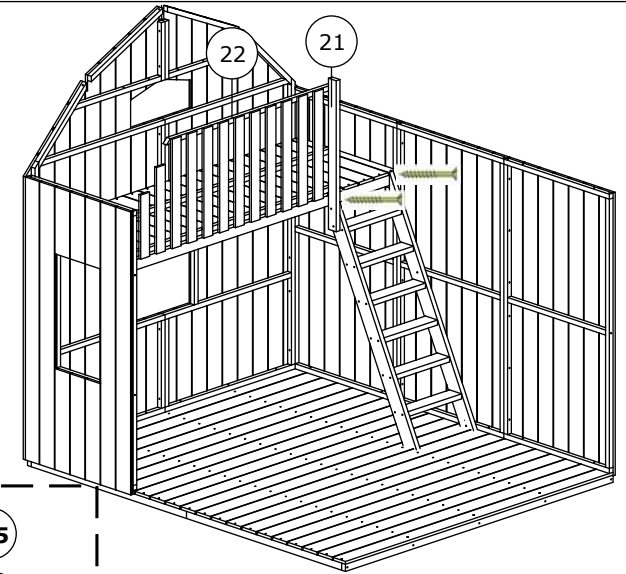
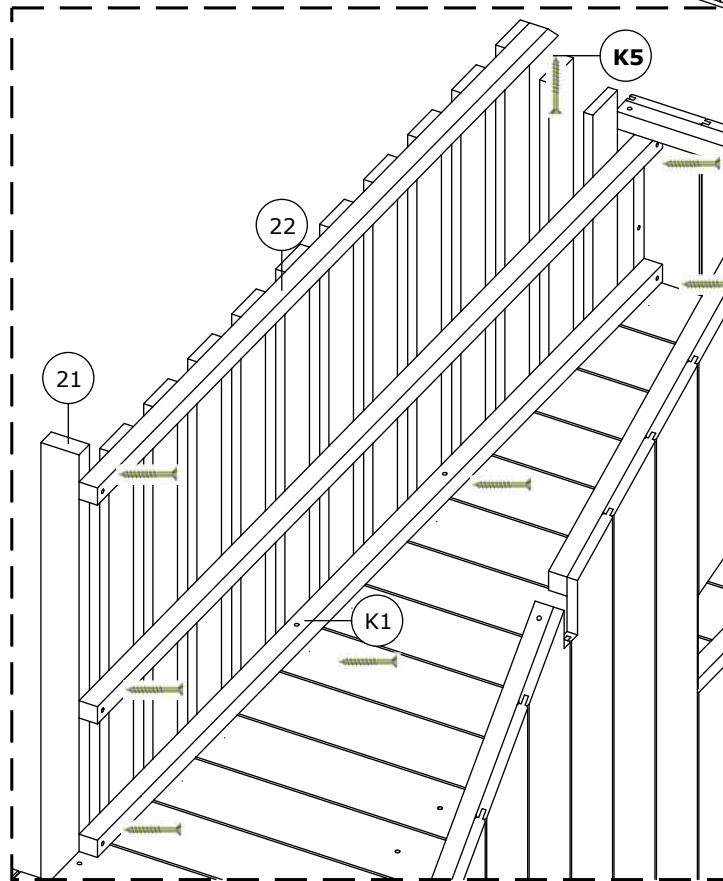
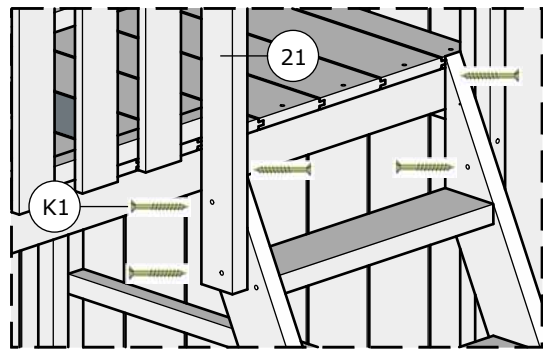
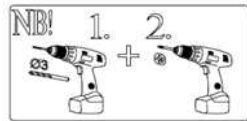
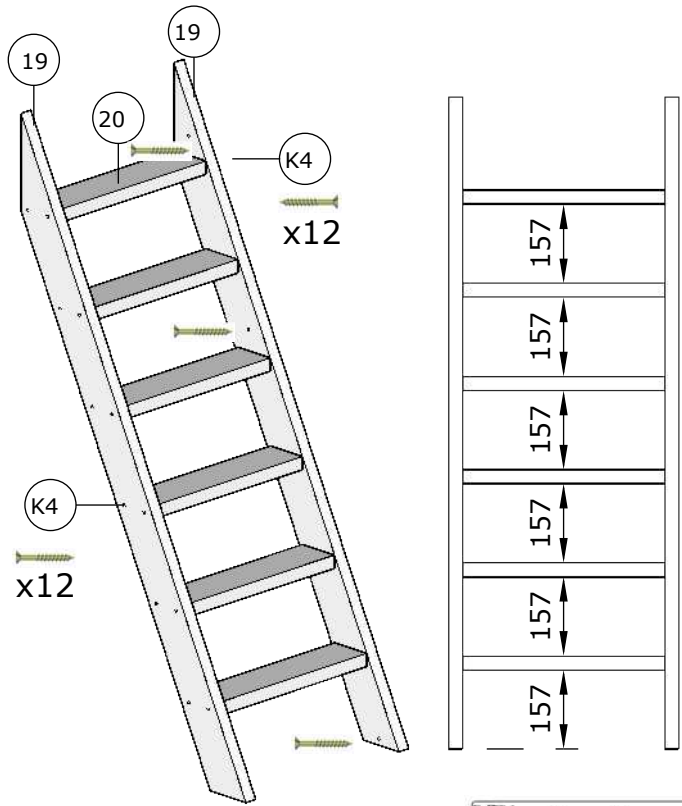

17	28x58x2000	3
18	16x114x733	18
K1	4,0x50 	7
K3	2,1x40 	54

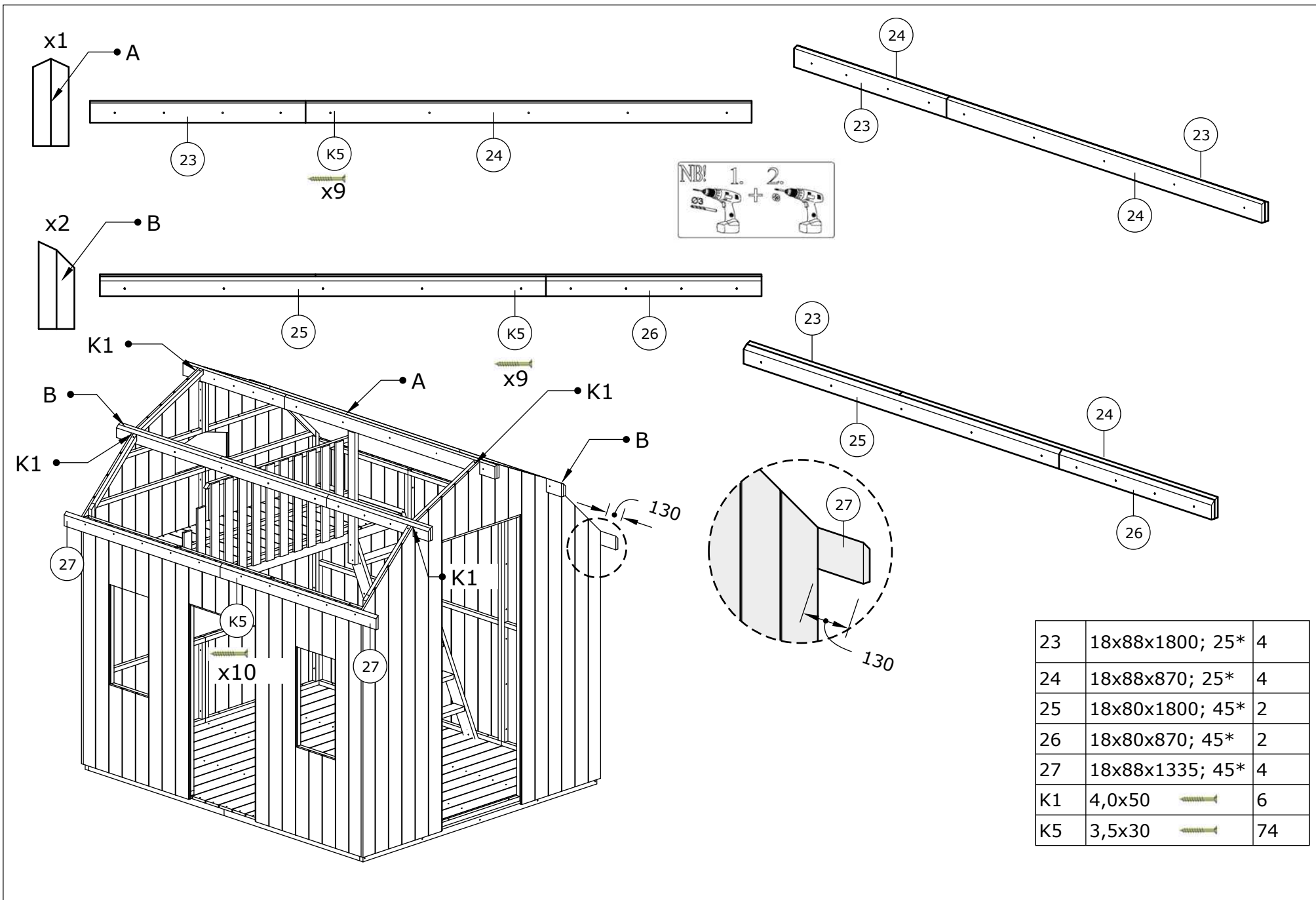

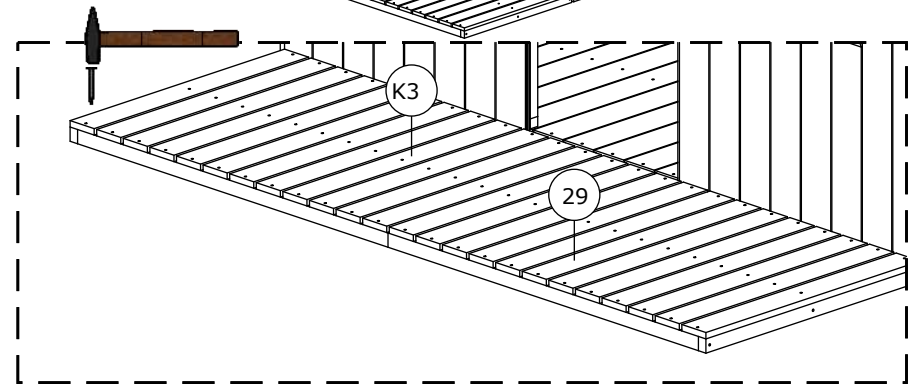
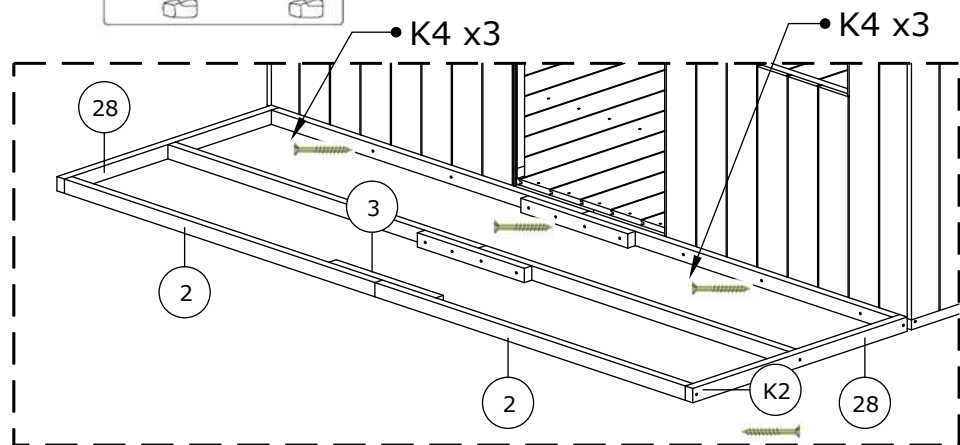
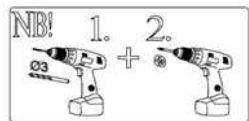
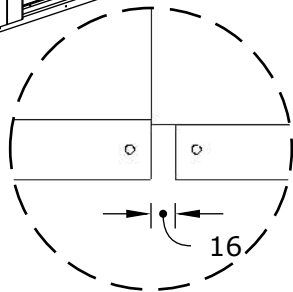
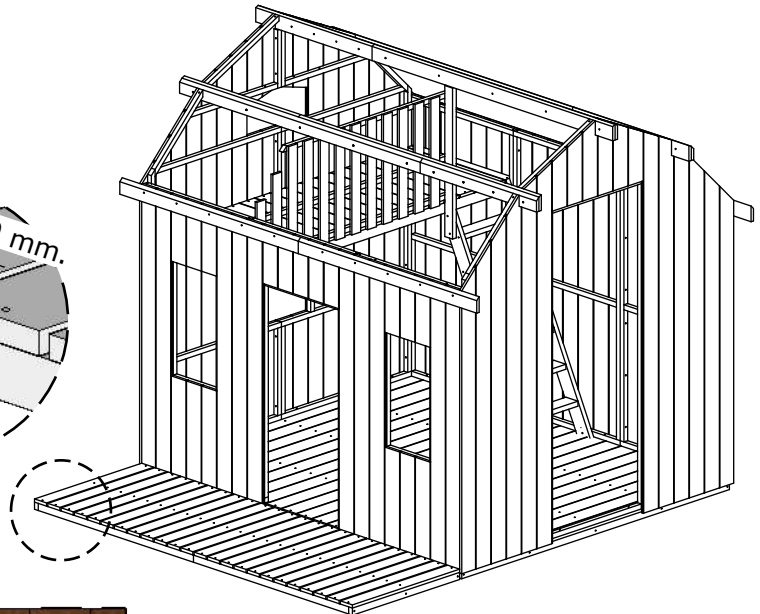
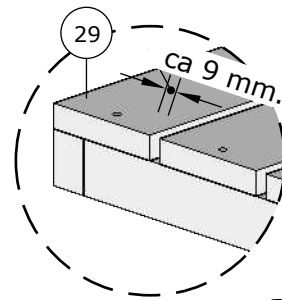
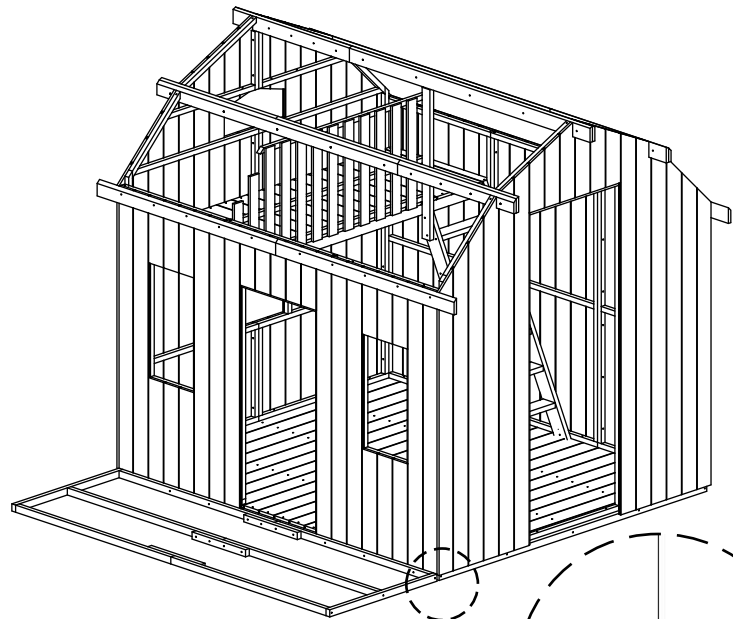

19	28x90x1438	2
20	28x90x400	6
21	28x58x845	1
22	42x625x1518	1
K1	4,0x50	14
K4	5,0x70	24
K5	3,5x30	1





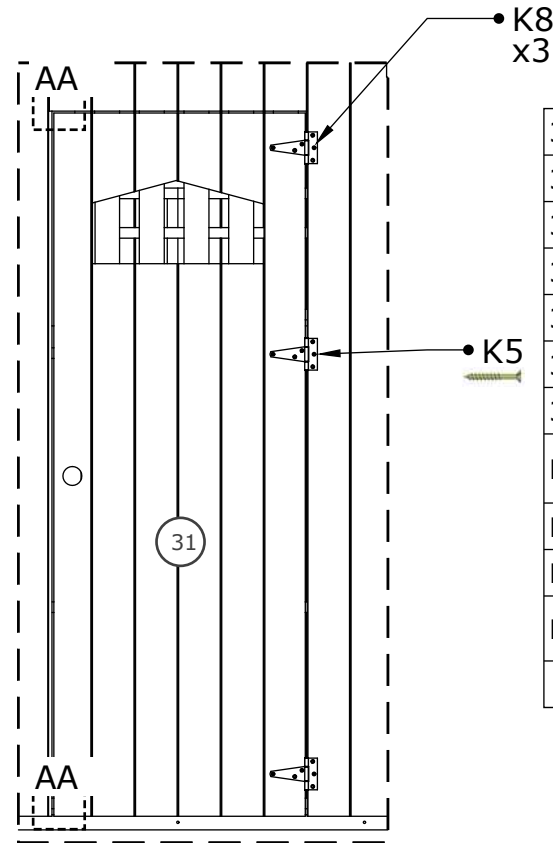
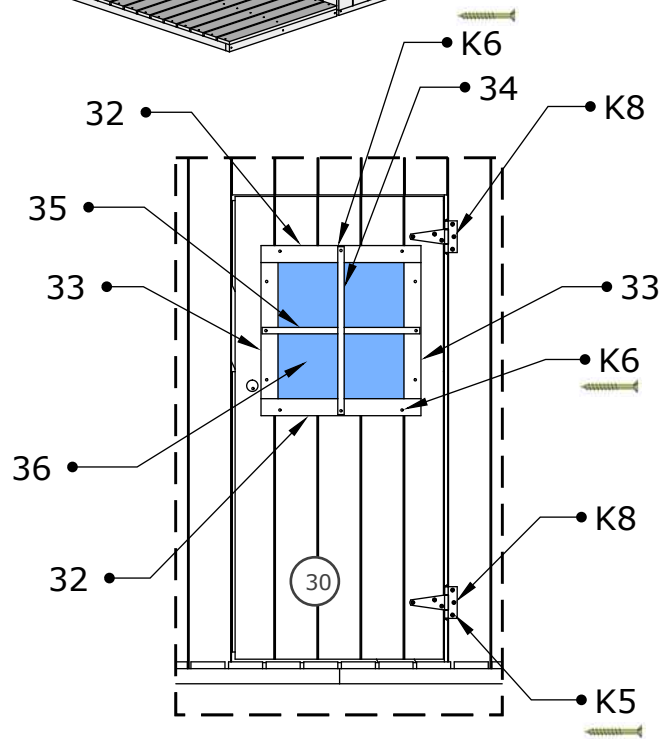
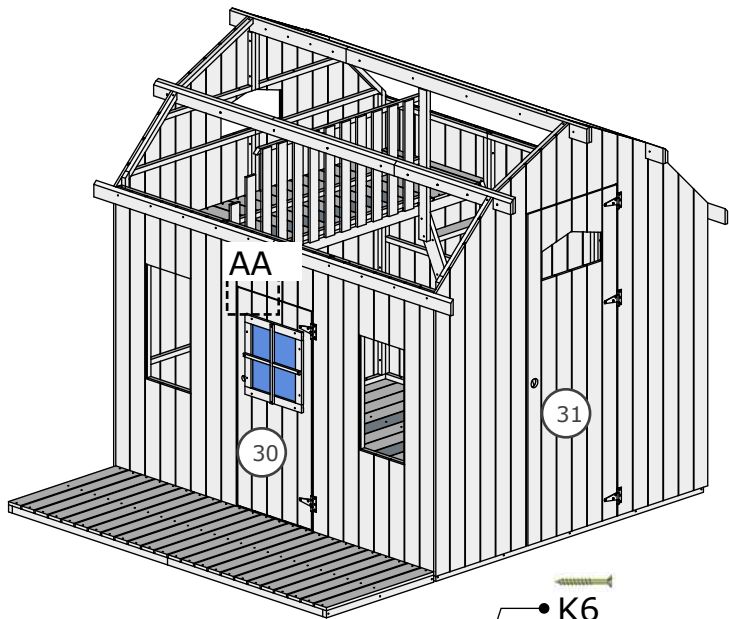

2	28x40x1161	6
3	28x40x400	3
28	28x40x802	2
29	18x90x802	24
K1	4,0x50 	12
K2	4,0x60 	6
K3	2,1x40 	80
K4	5,0x70 	6

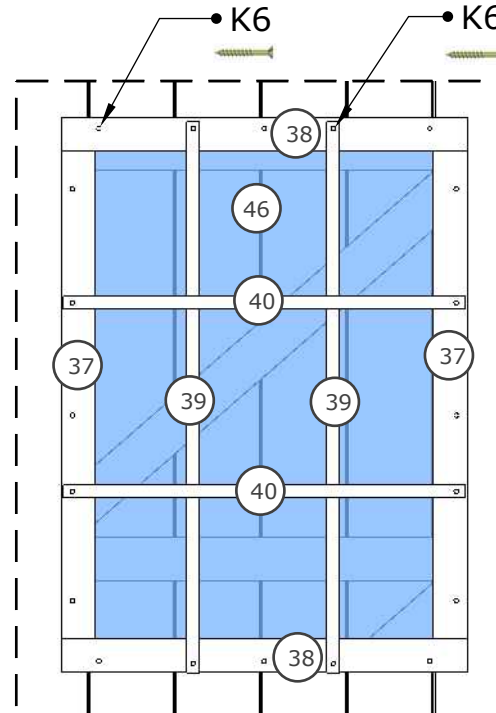
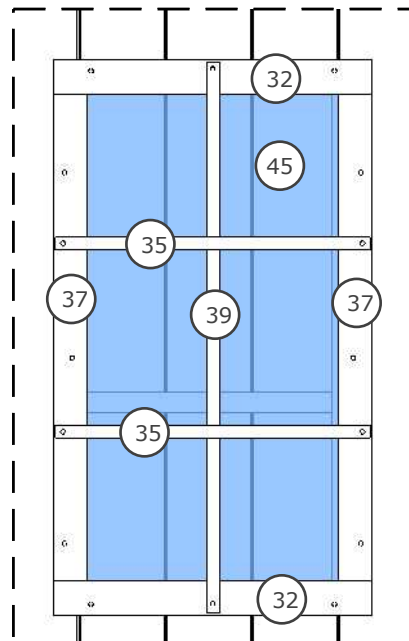
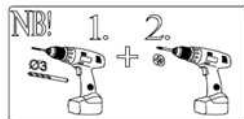
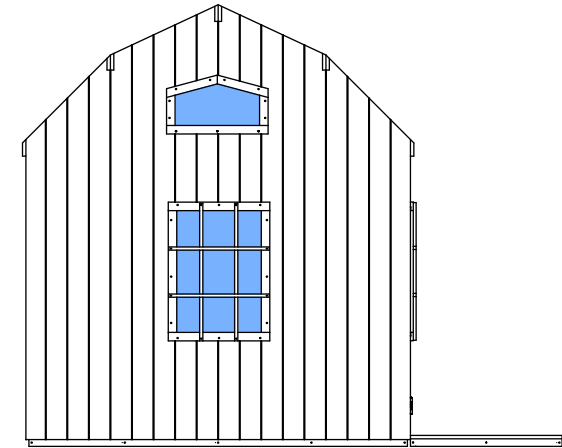
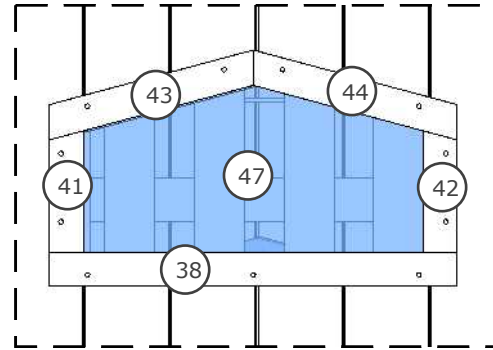
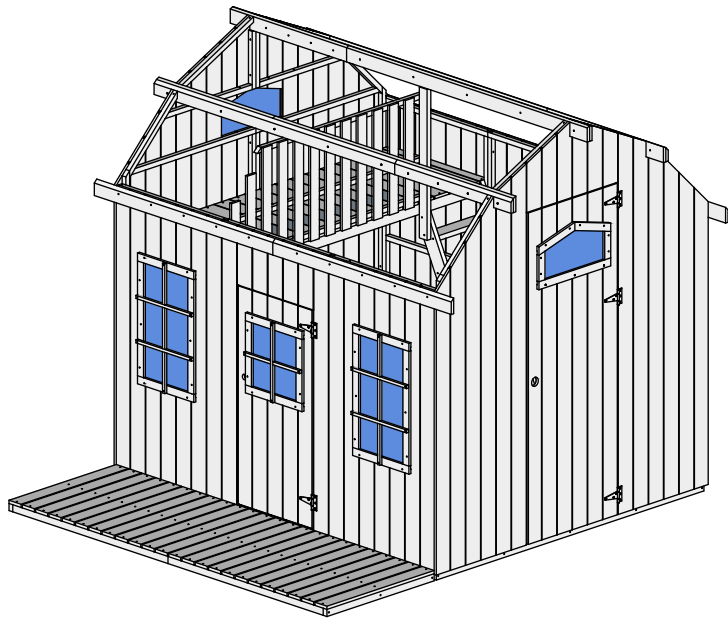

30	44x550x1220	1
31	44x665x1860	1
32	15x45x421	2
33	15x45x360	2
34	15x17x444	1
35	15x17x415	1
36	1,5x370x397	1
K8		5
K5	3,5x30	35
K6	3,5x25	12
K7		3



32	15x45x421	4
35	15x17x415	4
37	15x45x644	6
38	15x45x537	4
39	15x17x728	4
40	15x17x531	2
41	15x45x278; 15*	2
42	15x45x278; 15*	2
43	15x45x160; 15*	2
44	15x45x160; 15*	2
45	1,5x357x680	2
46	1,5x484x680	1
47	1,5x484x260; 15*+15*	2
K6	3,5x25 	74

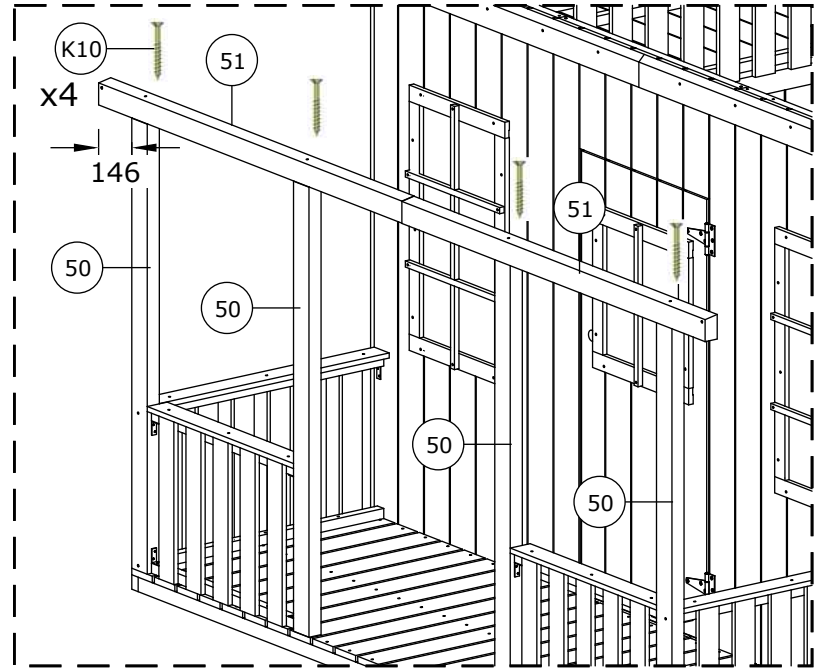
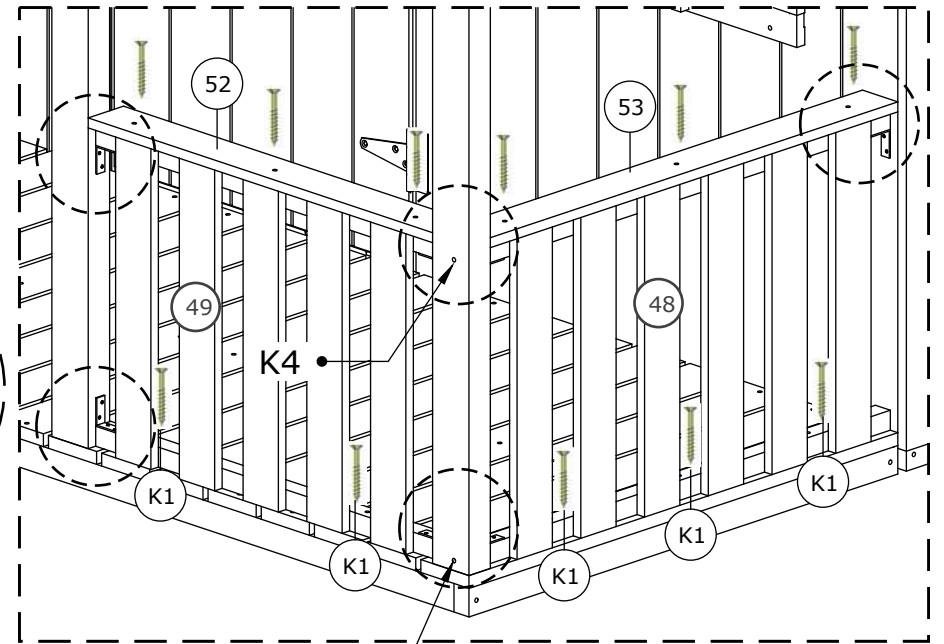
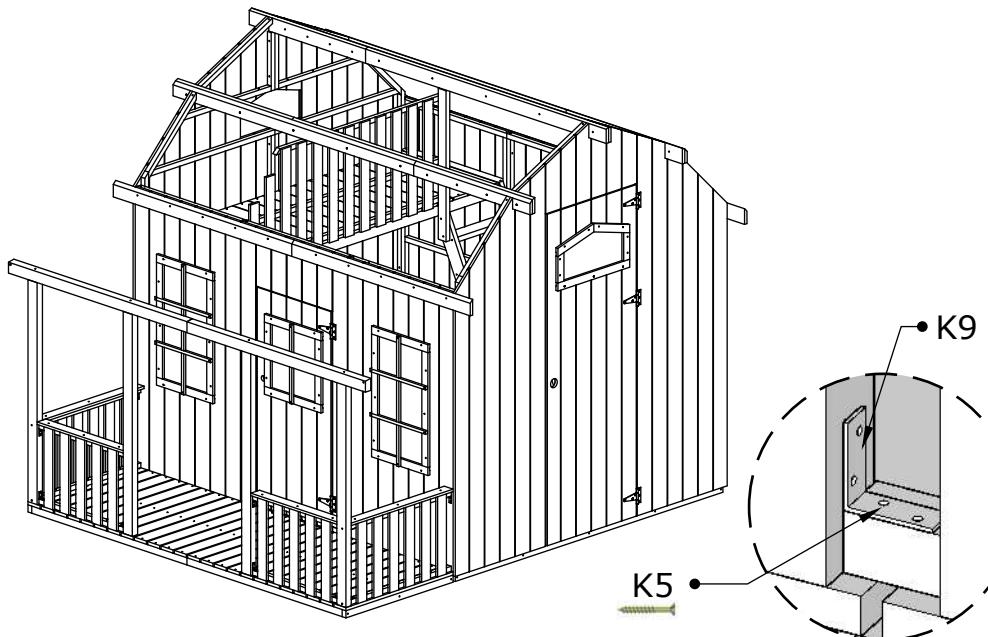

48	42x450x762	2
49	42x450x644	2
50	44x68x1245	4
51	40x68x1335; 10*	2
52	14x66x644	2
53	14x66x762	2
K1	4,0x50	10
K5	3,5x30	70
K4	5,0x70	4
K9		14
K10	5,0x120	4

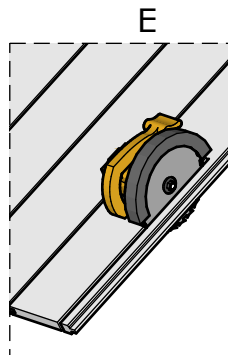
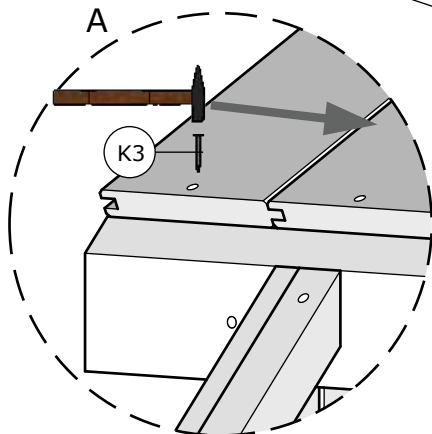
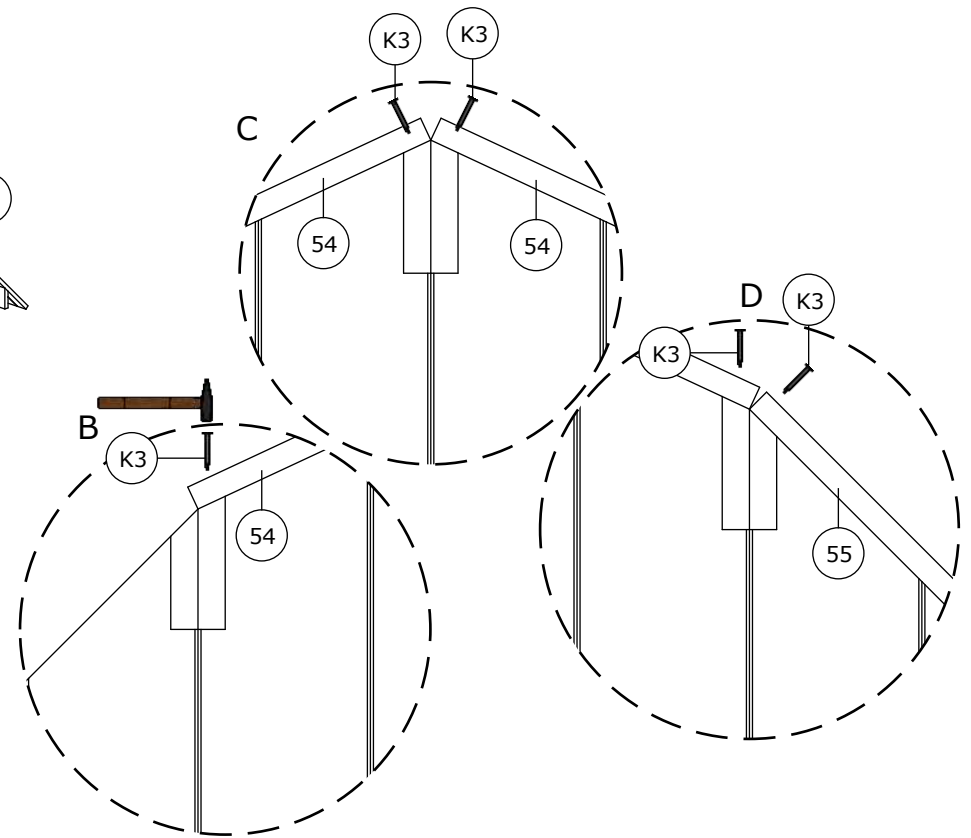
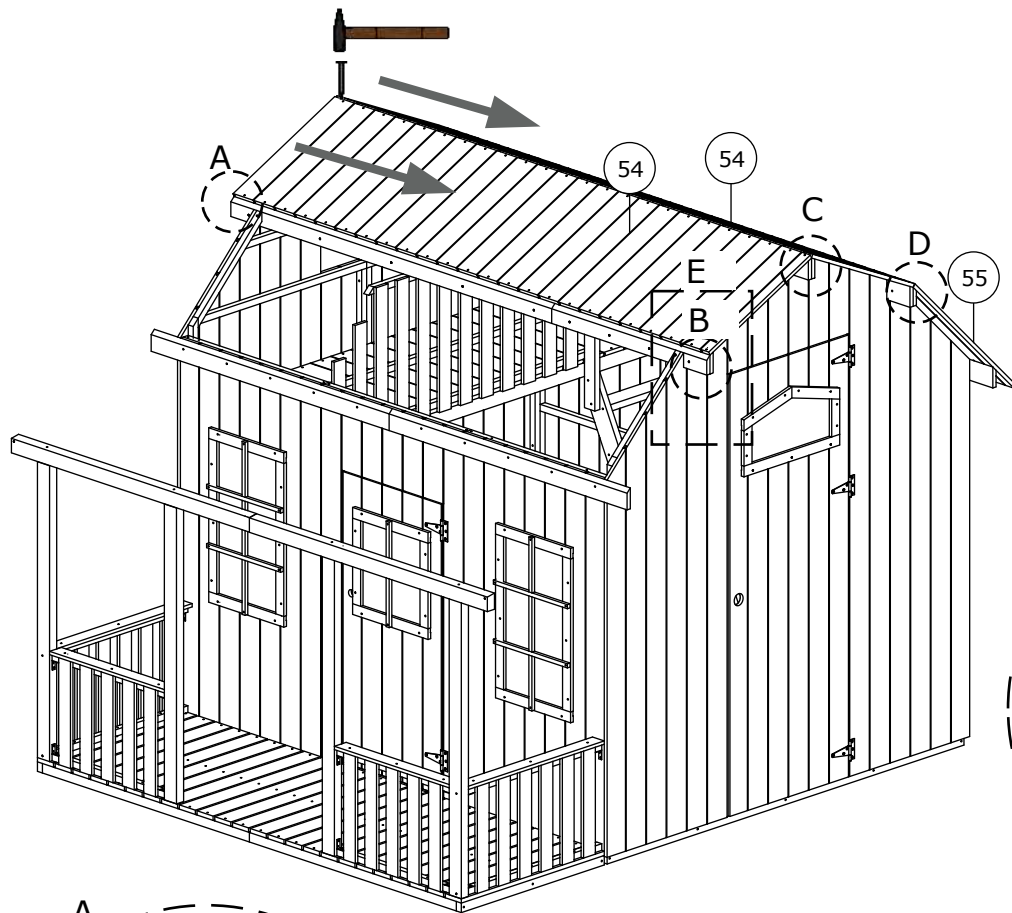

54	16x114x630	48
55	16x114x800	24
K3	2,1x40	180

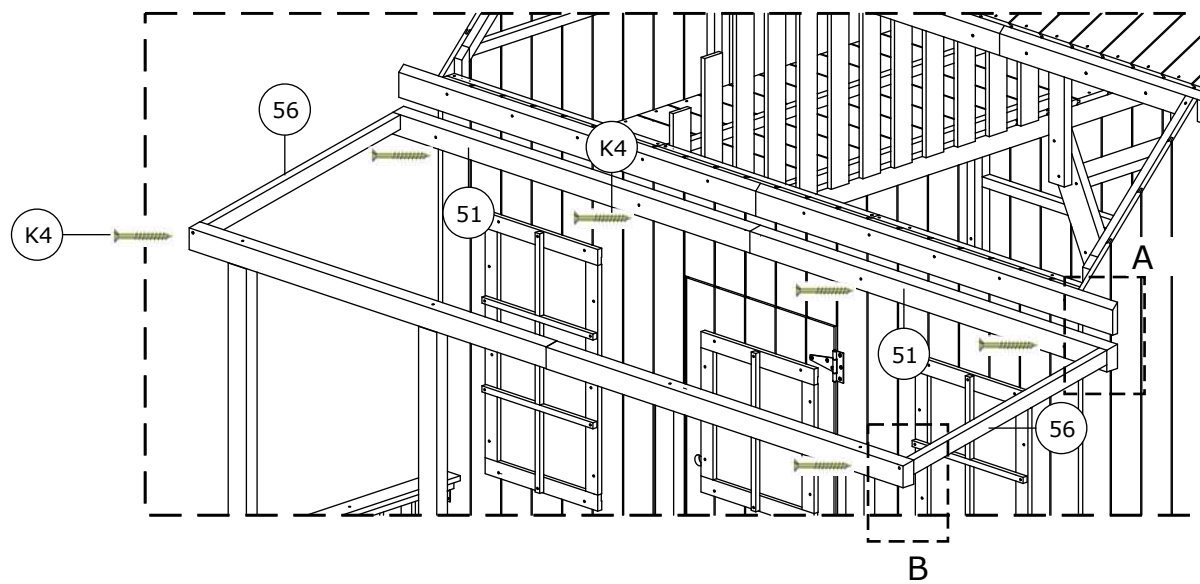
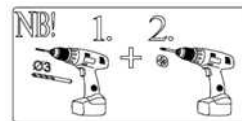
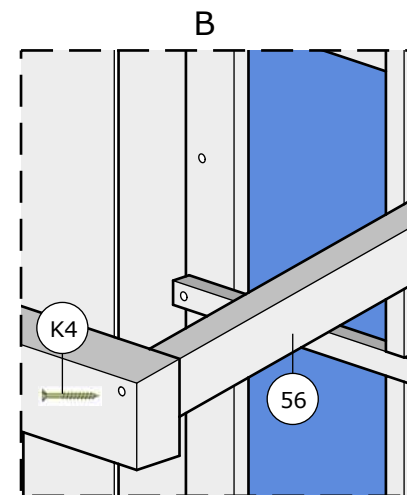
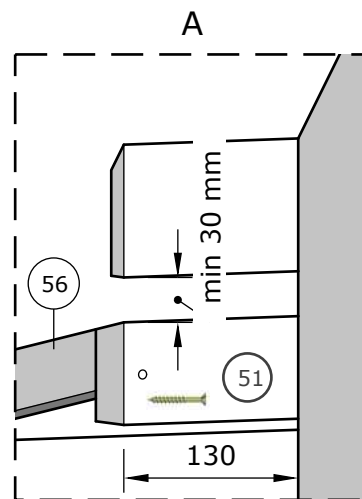
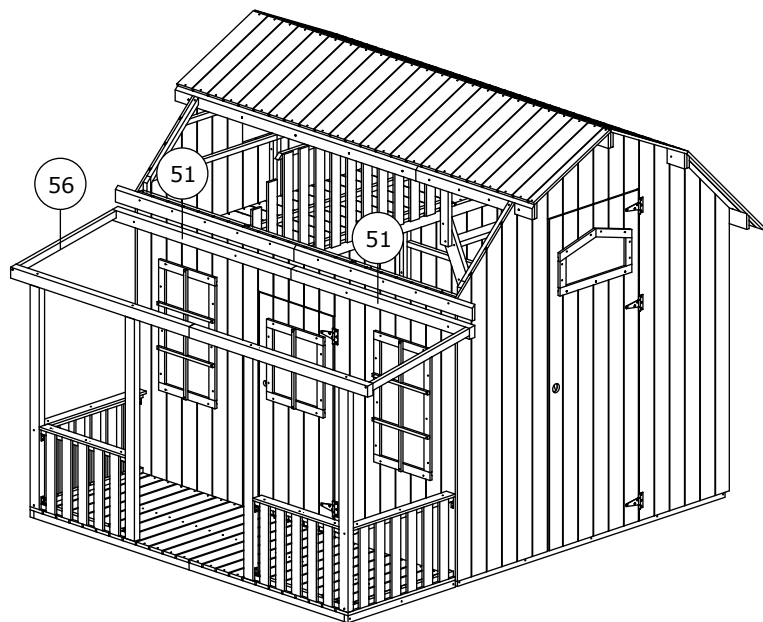

51	40x68x1335; 10*	2
56	28x40x733; 10*+10*	2
K4	5,0x70 	8

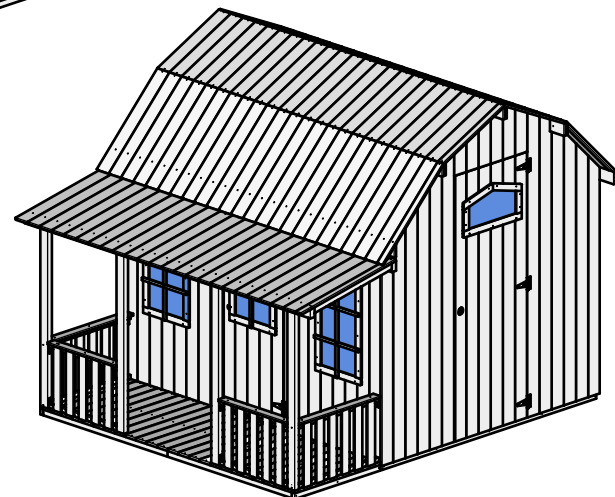
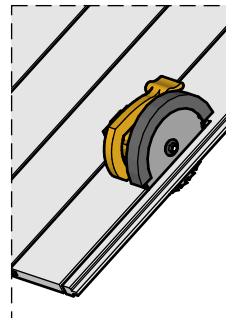
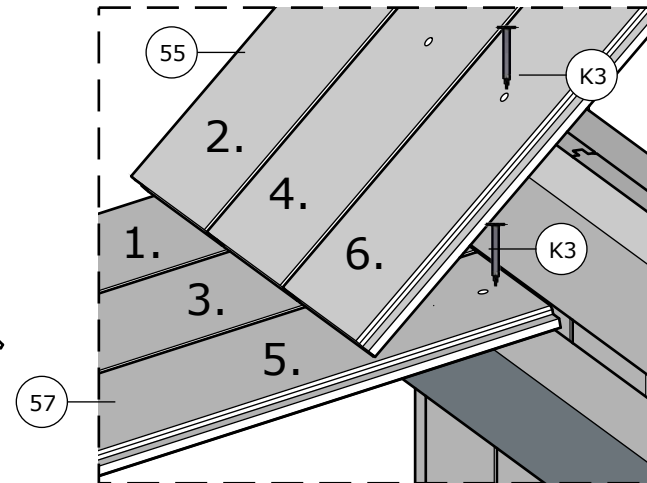
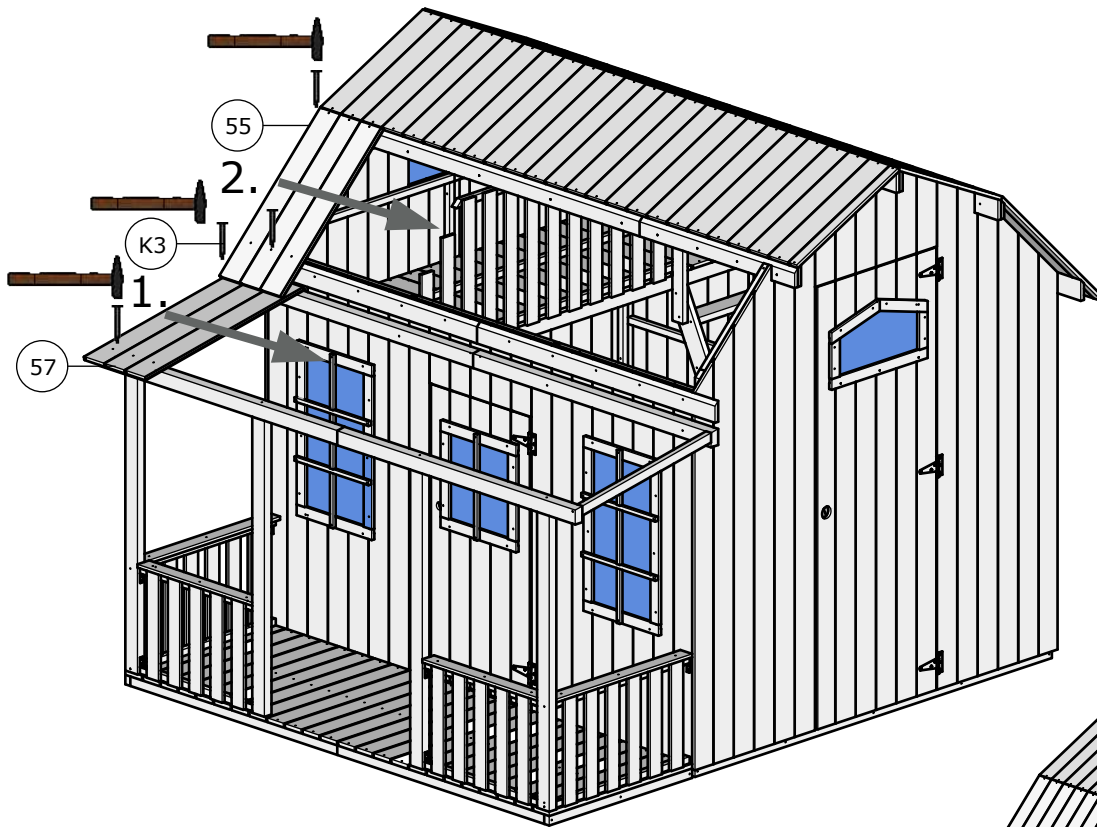

55	16x114x800	24
57	16x114x900	24
K3	2,1x40	100

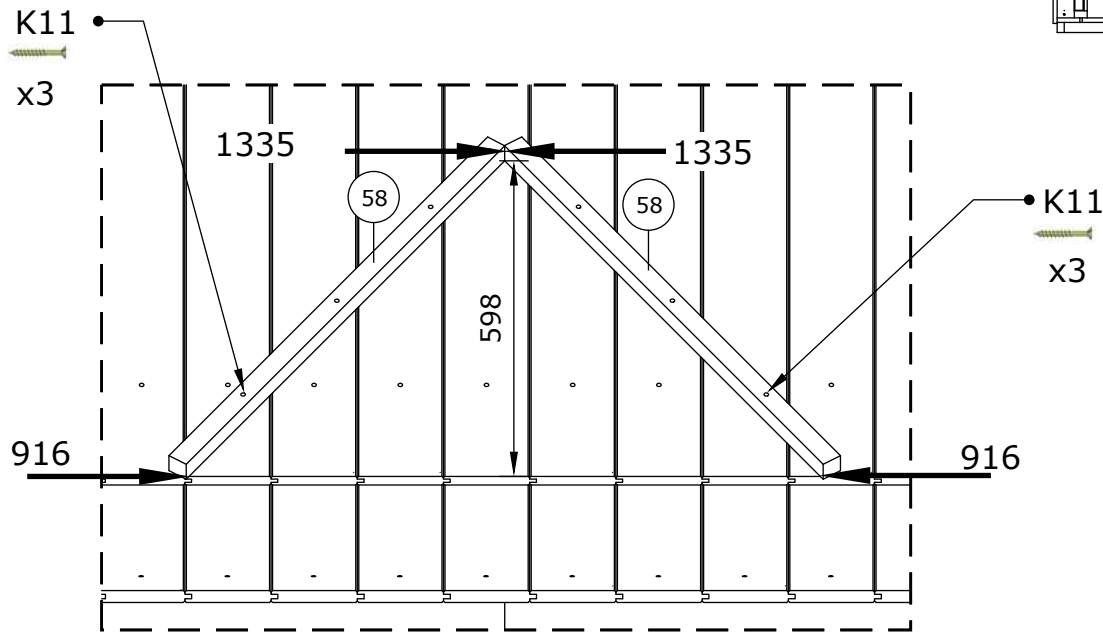
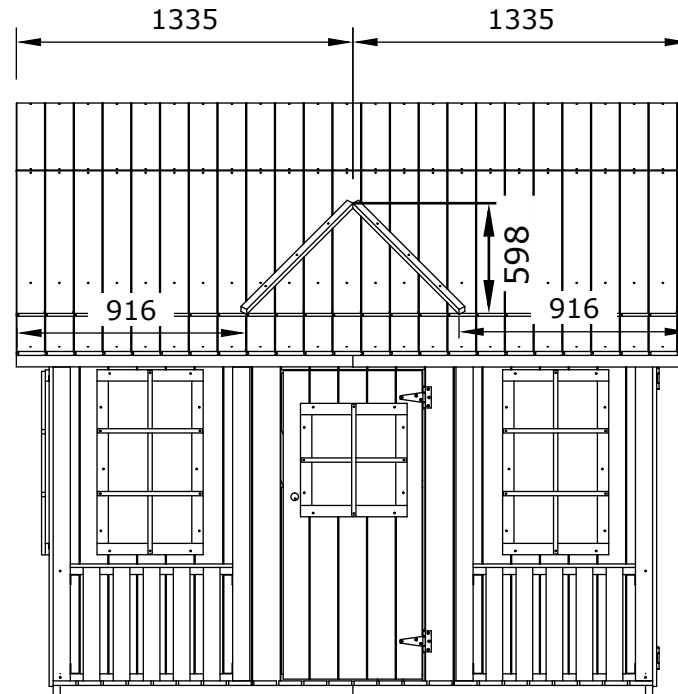
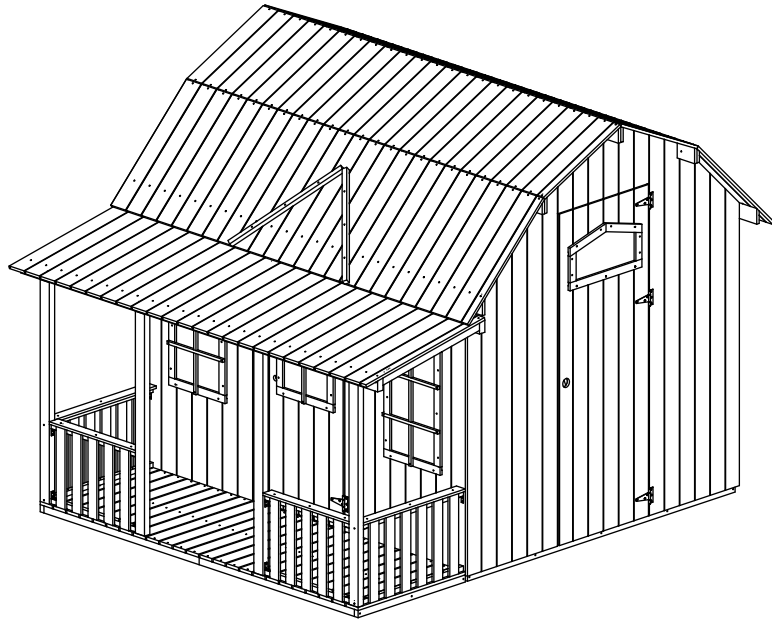

58	28x28x730	2
K11	3,5x40	6

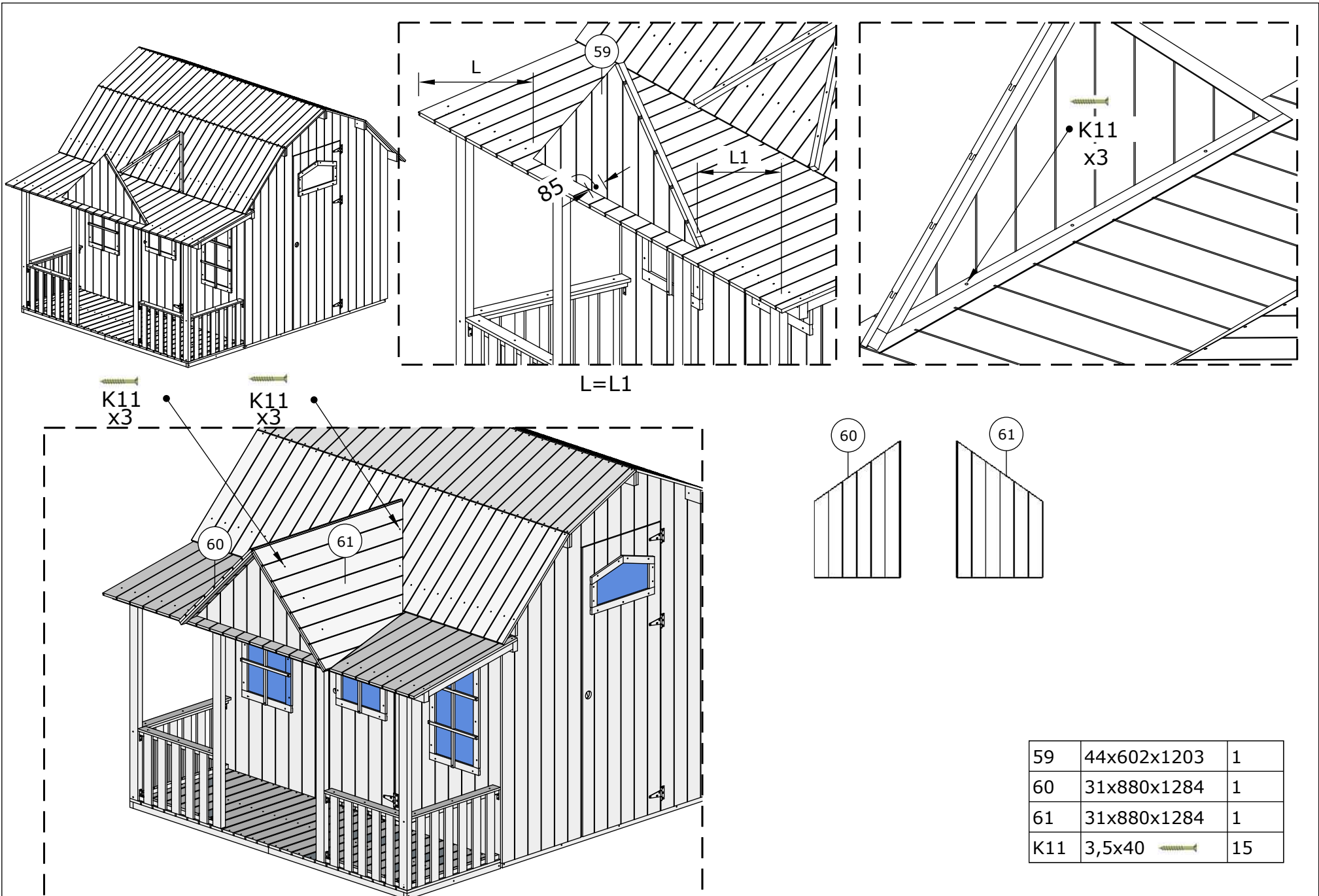

59	44x602x1203	1
60	31x880x1284	1
61	31x880x1284	1
K11	3,5x40 	15

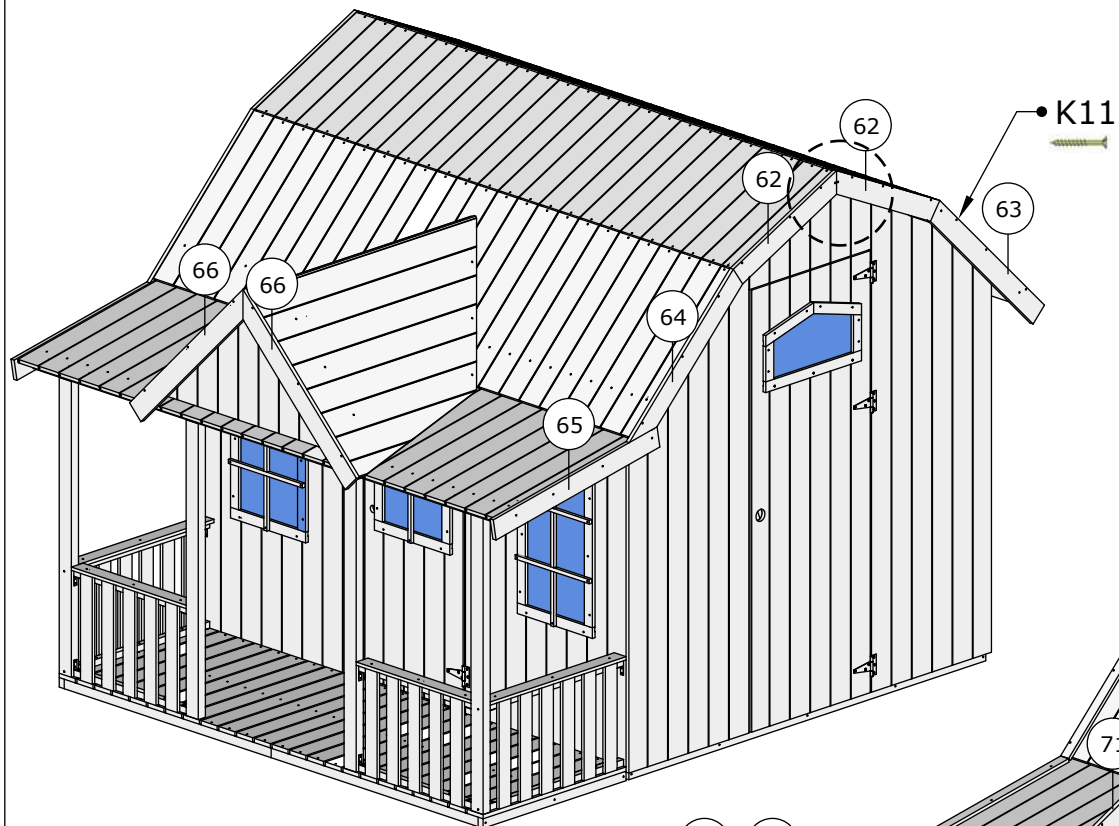

67	15x45x640	4
68	15x45x830	2
69	15x45x820	2
70	15x45x775	2
71	15x45x900	2
K11	3,5x40	40

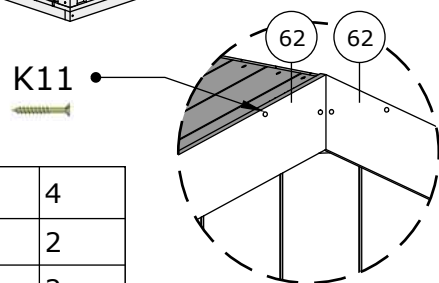
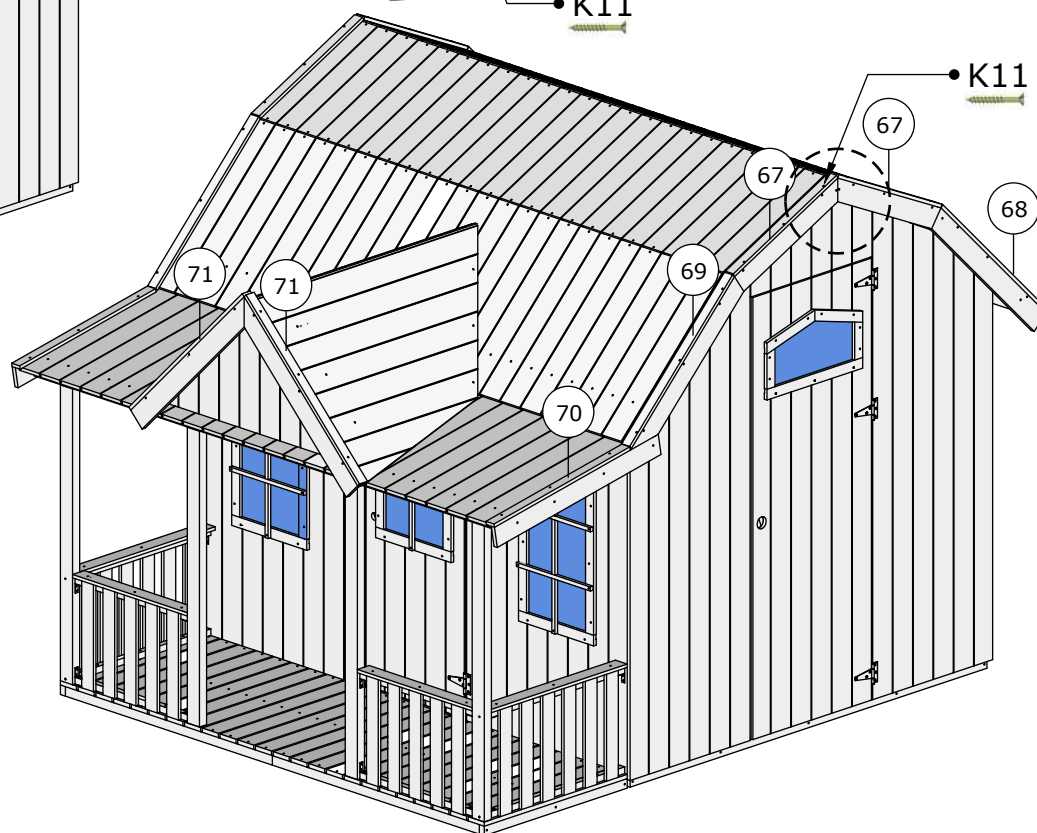
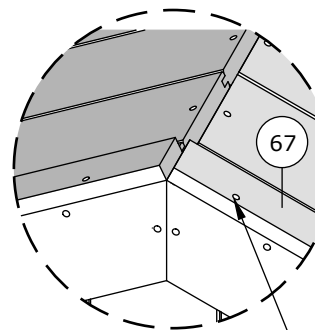

62	18x90x639; 10*+25*	4
63	18x90x830; 10*	2
64	18x90x825; 10*+35*	2
65	18x90x930	2
66	18x90x900; 45*	2
K11	3,5x40	45

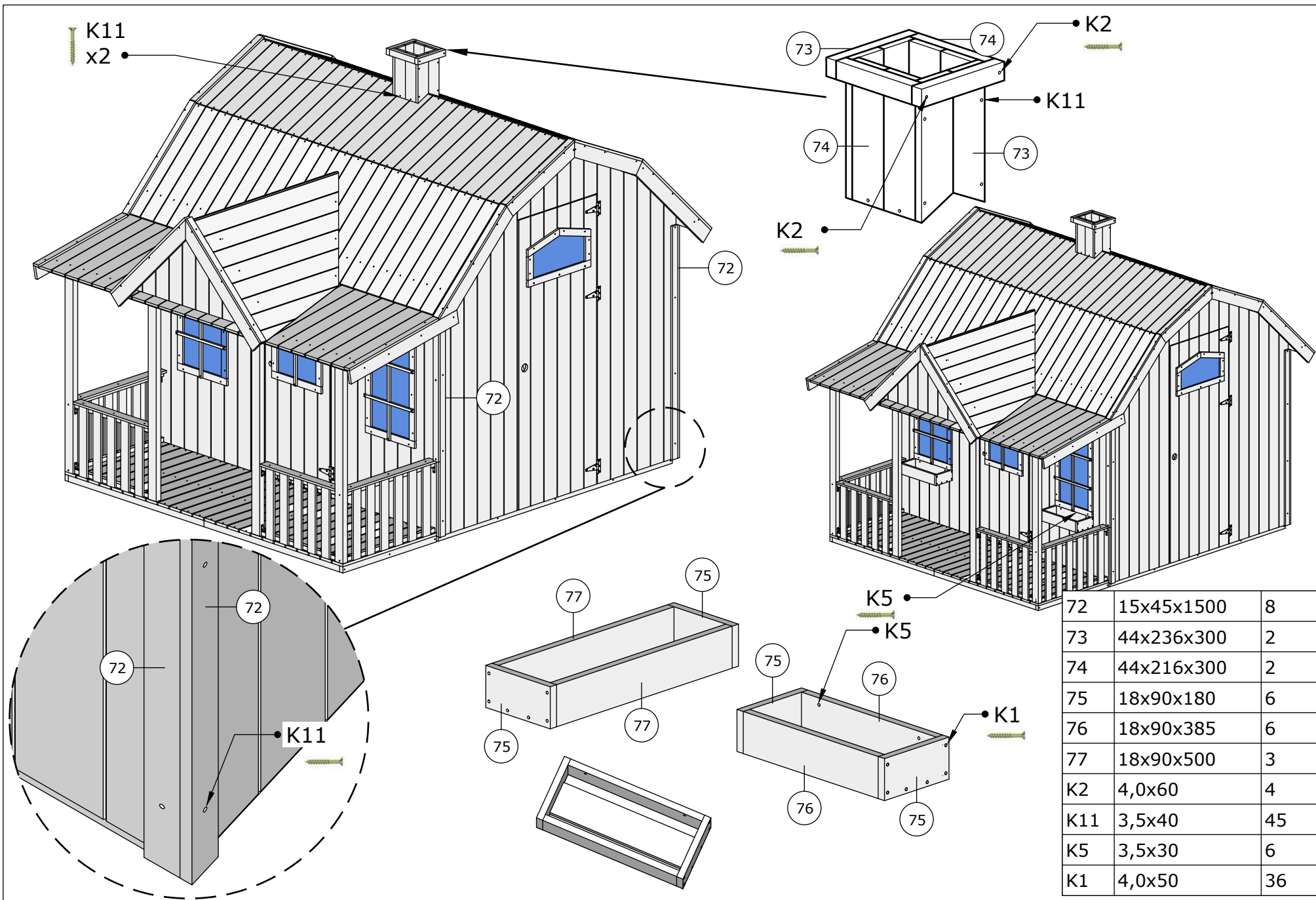

72	15x45x1500	8
73	44x236x300	2
74	44x216x300	2
75	18x90x180	6
76	18x90x385	6
77	18x90x500	3
K2	4,0x60	4
K11	3,5x40	45
K5	3,5x30	6
K1	4,0x50	36