

Canberra

4412195

1/8

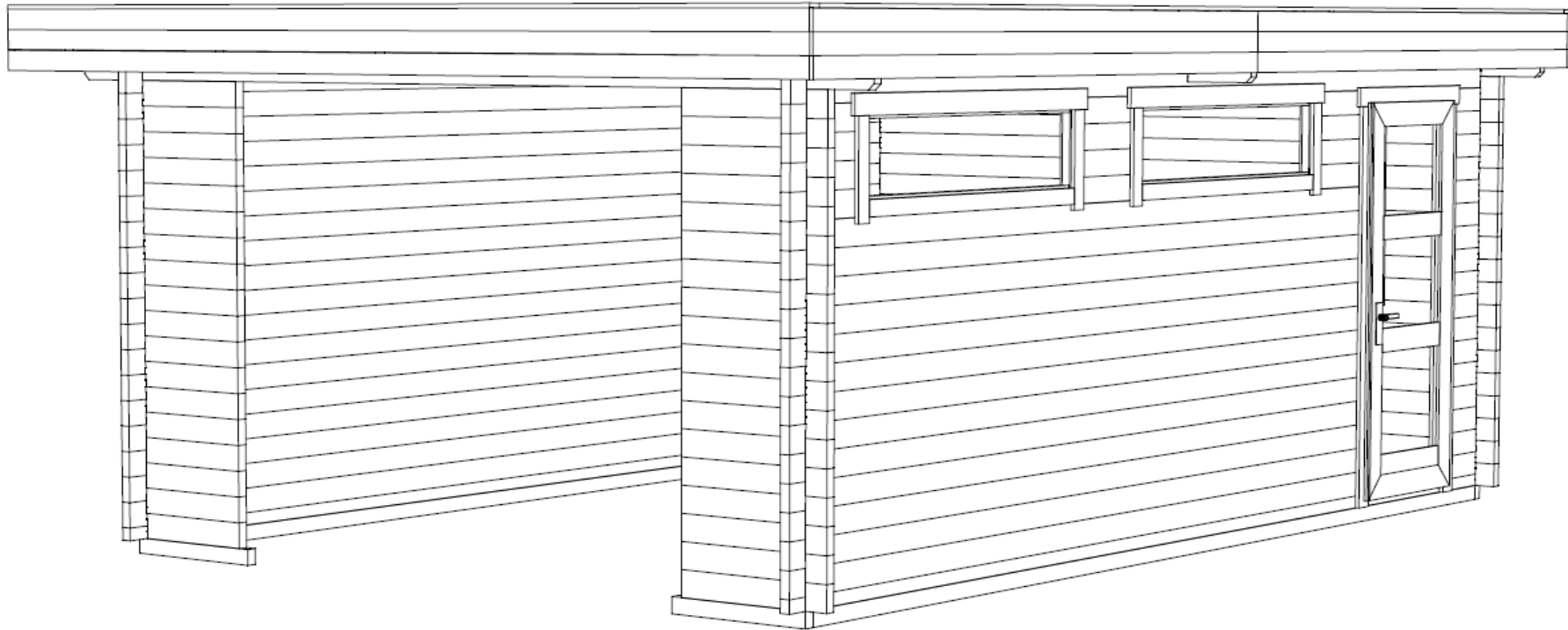

44x114

19.03.2015

GROUNDPLAN - GRUNDPLAN - PLAN DE MASSE

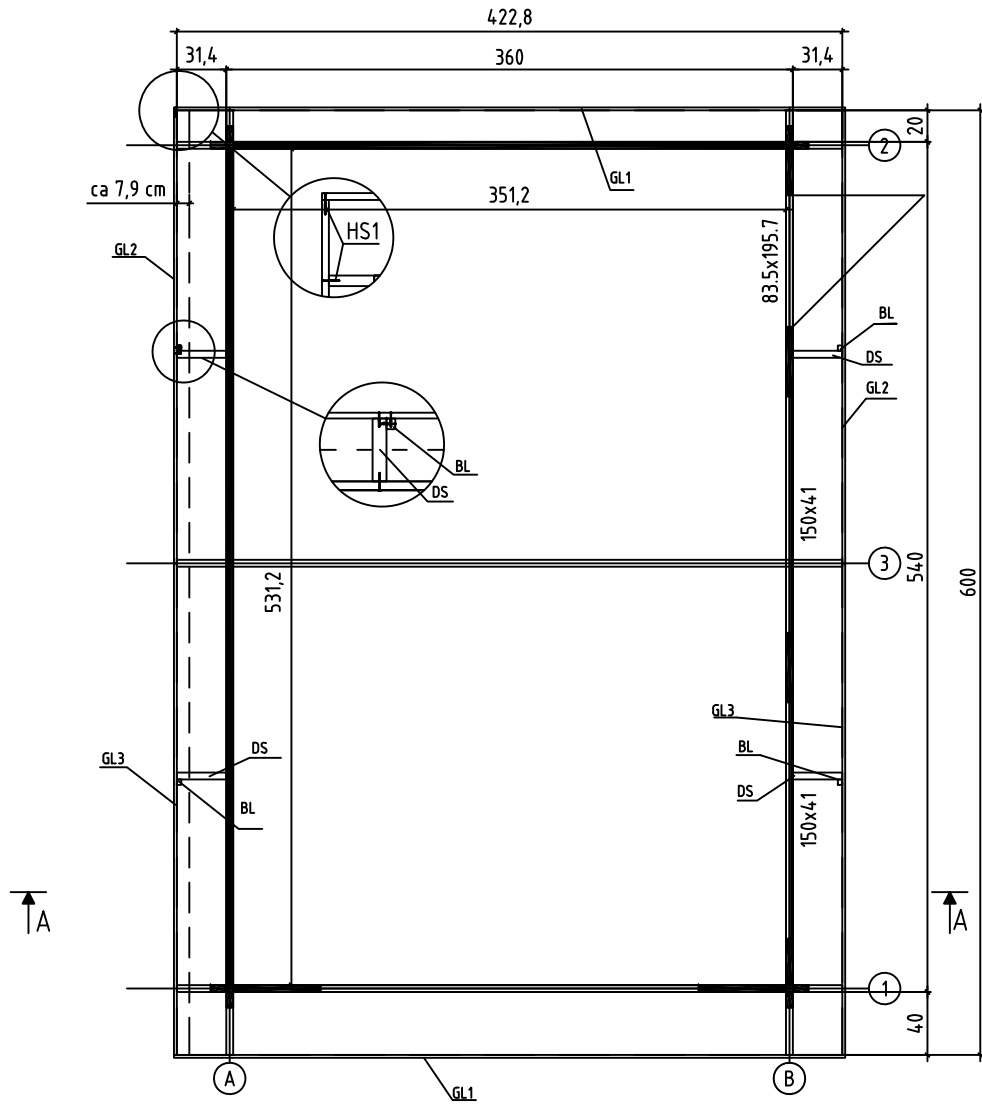

FOUNDATION - FUNDAMENT - FONDATION

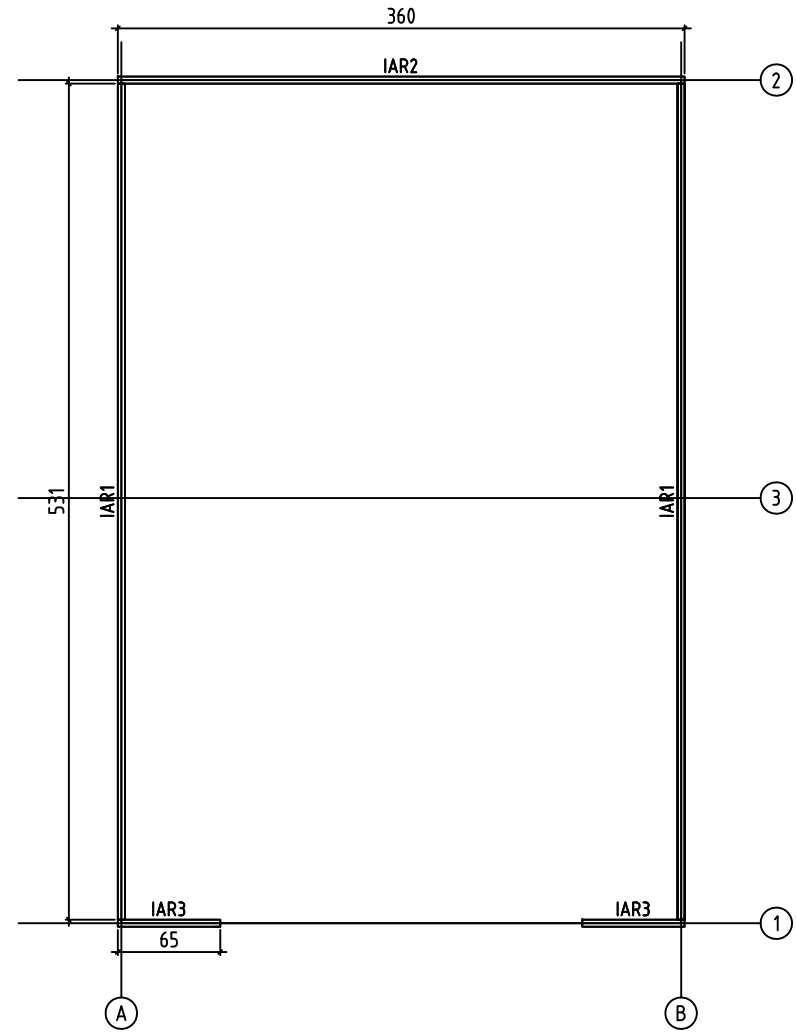

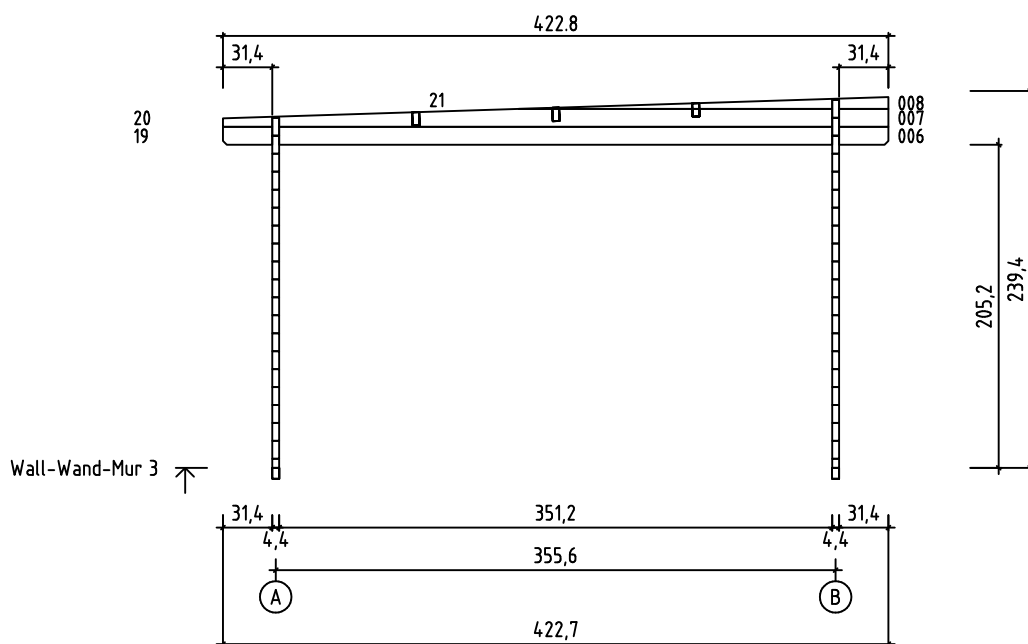
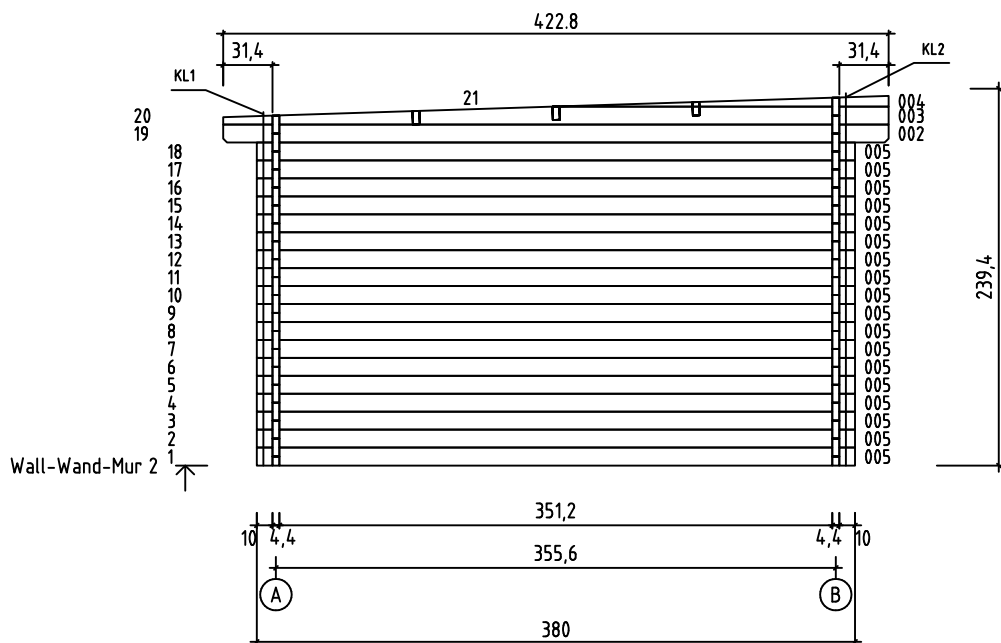
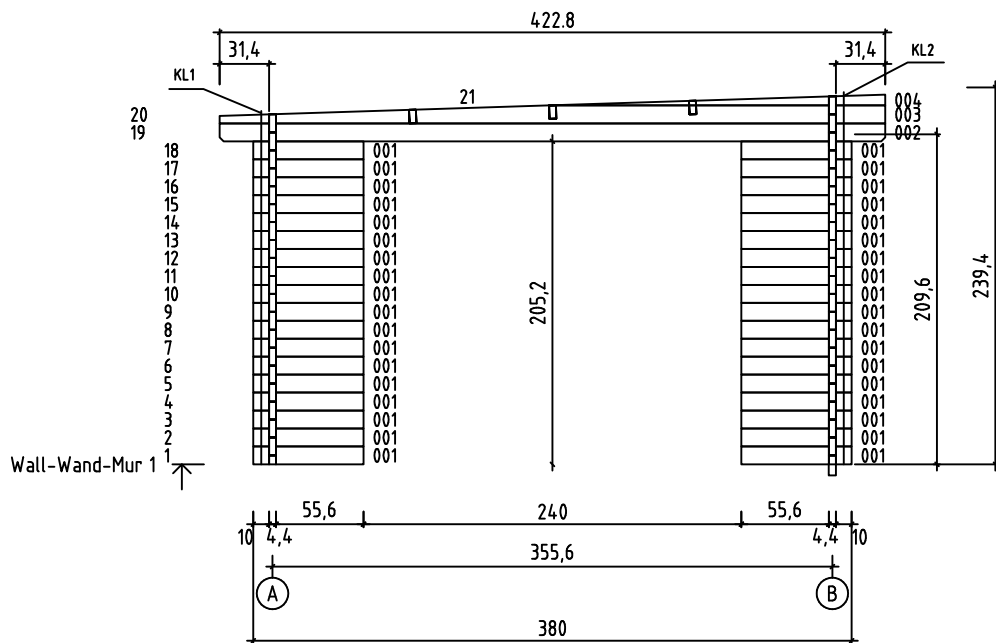



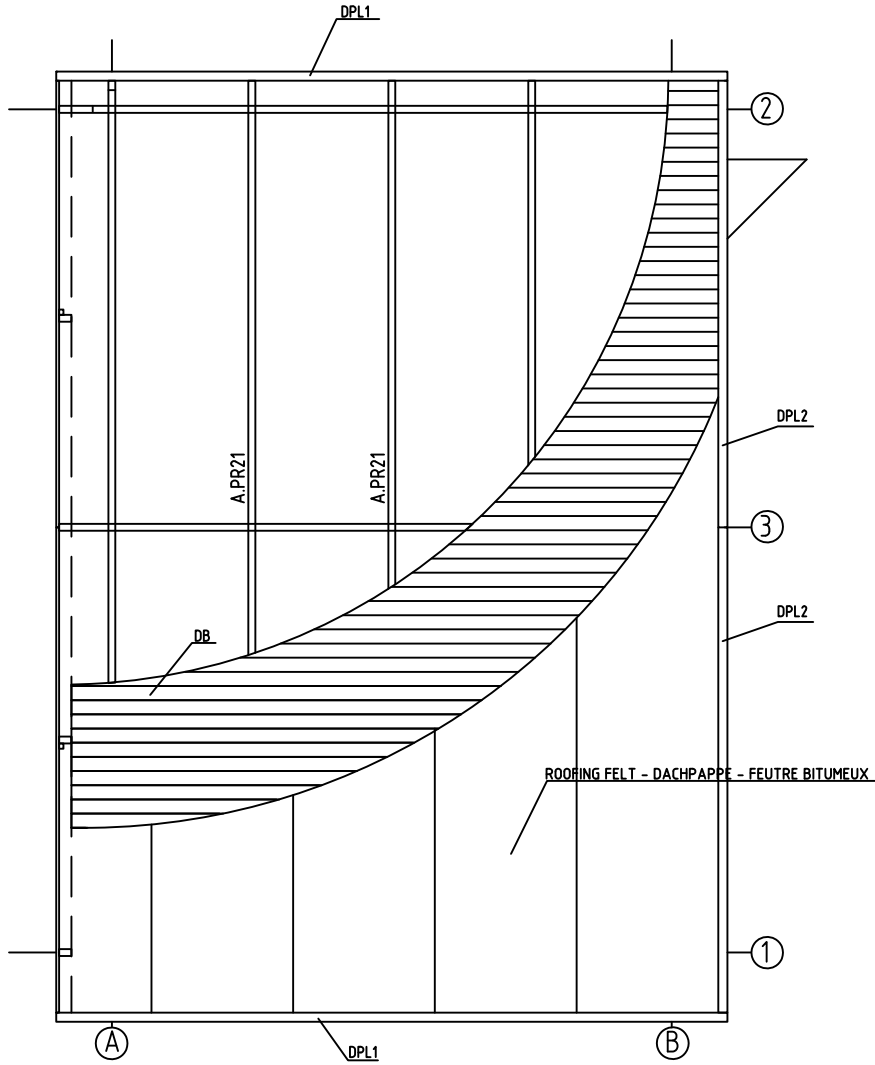



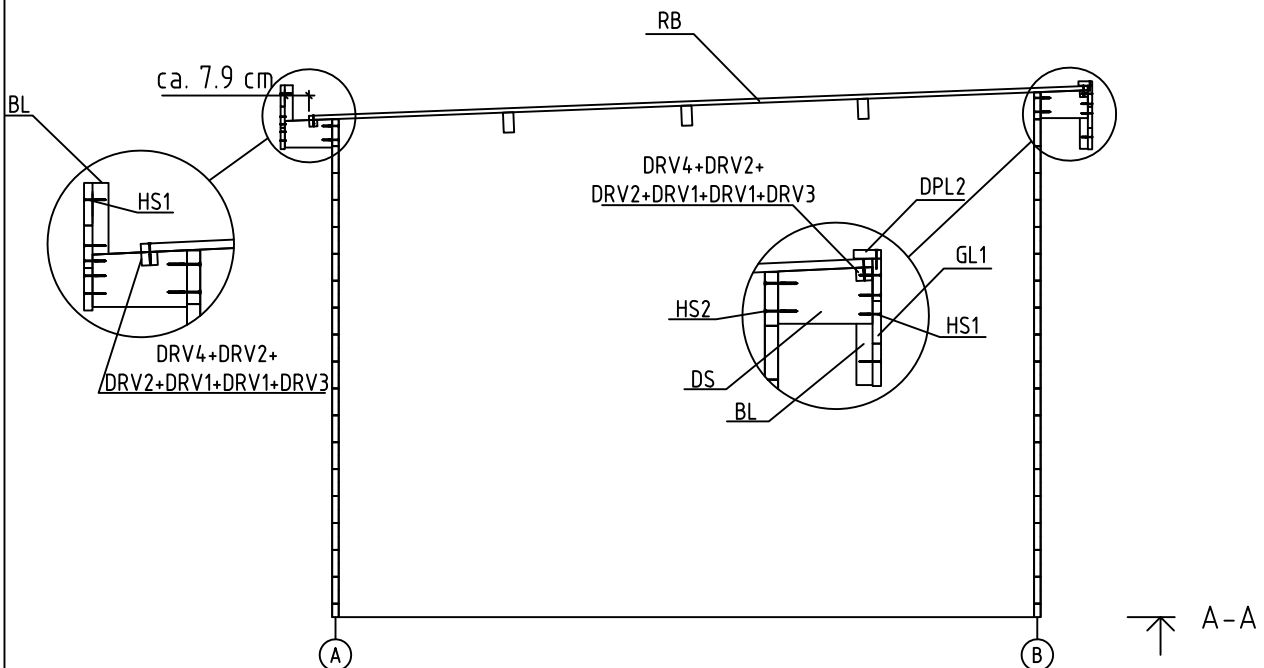

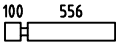
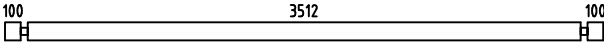
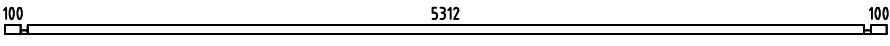
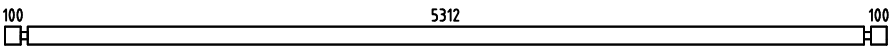
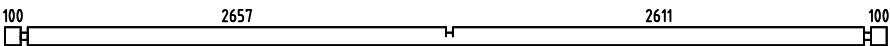
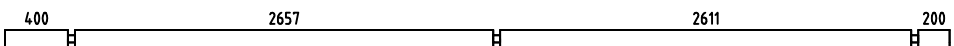
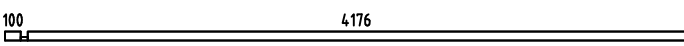

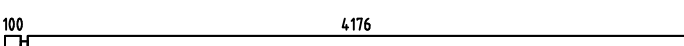



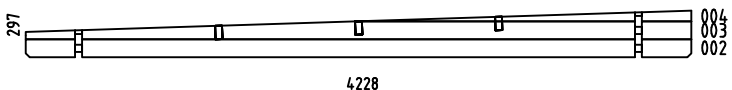
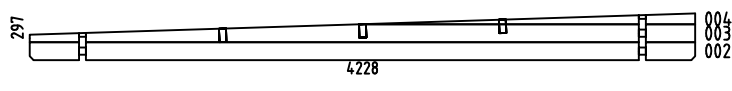
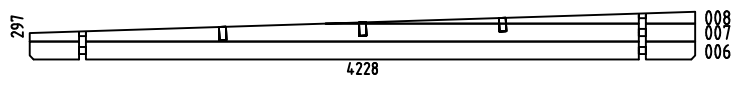
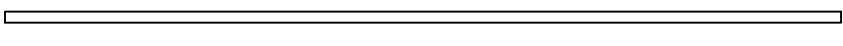
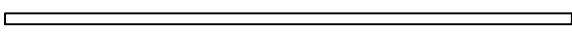
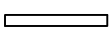
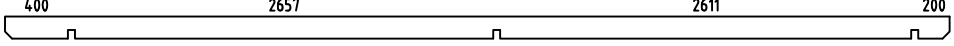
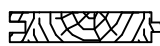



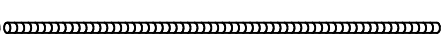

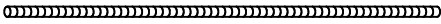

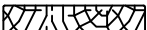
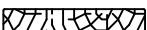



ROOF PLAN - DACH-PLAN - PLAN DU TOIT



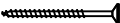
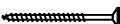
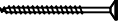
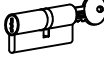
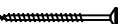
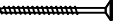
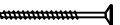

CROSS SECTION - SCHNITT - VU DE COUPE

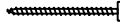

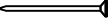
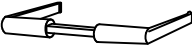
Pos	19.03.2015	Piece list - Stückliste - Liste des pièces Art. Nr. 4412195	6/8	Q.	P (mm)	L (mm)
001				36	44x114	700
005				18	44x114	3800
009				1	44x57	5600
010				17	44x114	5600
011				2	44x114	5600
012				2	44x114	6000
013				1	44x57	4320
014				1	44x57	435
015				13	44x114	4320
016				21	44x114	435
017				8	44x114	435
018				1	44x114	6000
W1-1				1		
W2-1				1		
W3-1				1		
IAR1		FOUNDATION - FUNDAMENT - FONDATION 		2	45x70	5310
IAR2		FOUNDATION - FUNDAMENT - FONDATION 		1	45x70	3600
IAR3		FOUNDATION - FUNDAMENT - FONDATION 		2	45x70	650
A.PR21		ROOF BEAM - DACHBALKEN - PANNE DE TOIT 		3	44x140	6000
DB		ROOF BOARDS - DACHBRETTER - VOLIGES 		67	90x18	4150
DPL2		ROOFING FELT FILLET - DACHPAPPENLEISTE - BAGUETTE DE FIXATION DU FEUTRE BITUMEUX 		2	18x58	2960
DPL1		ROOFING FELT FILLET - DACHPAPPENLEISTE - BAGUETTE DE FIXATION DU FEUTRE BITUMEUX 		2	18x58	4264
BL		ROOF EDGE REINFORCEMENT - DACHRANDVERSTÄRKUNG - CORNIERE DE RENFORT DE BORD DE TOIT 		4	28x34	220
KL1		TREADED ROD M10 - GEWINDESTANGE M10 - TIGE FILETÉE M10 		2		245

Pos	19.03.2015	Piece list - Stückliste - Liste des pièces Art. Nr. 4412195	7/8	Q.	P (mm)	L (mm)
KL2	TREADED ROD M10 - GEWINDESTANGE M10 - TIGE FILETÉE M10			2		365
KL1/KL2	TREADED ROD M10 - GEWINDESTANGE M10 - TIGE FILETÉE M10			4		2000
GL2	EAVES BOARD - TRAUFBRETT - BANDEAU DE TOIT			6	18x90	2877
GL3	EAVES BOARD - TRAUFBRETT - BANDEAU DE TOIT			6	18x90	3123
GL1	EAVES BOARD - TRAUFBRETT - BANDEAU DE TOIT			6	18x90	4264
DRV 1	ROOF EDGE REINFORCEMENT - DACHRANDVERSTÄRKUNG - CORNIERE DE RENFORT DE BORD DE TOIT			4	28x34	1284
DRV 2	ROOF EDGE REINFORCEMENT - DACHRANDVERSTÄRKUNG - CORNIERE DE RENFORT DE BORD DE TOIT			4	28x34	1306
DRV 3	ROOF EDGE REINFORCEMENT - DACHRANDVERSTÄRKUNG - CORNIERE DE RENFORT DE BORD DE TOIT			2	28x34	200
DRV 4	ROOF EDGE REINFORCEMENT - DACHRANDVERSTÄRKUNG - CORNIERE DE RENFORT DE BORD DE TOIT			2	28x34	400
	SUPPORT BEAM FOR GATE FRAME - STUTZBOHLE FÜR TORZARGE - MADRIER DE SUPPORT DU CADRE DE LA PORTE BASCULANTE			1	44x140	3510
DS	DISTANCE SPACERS FOR GABLE MOULDING - DACHSTÜZEN - SUPPORTS EXTENSION TOITURE			4	44x120	319
	LENGTHENING BOLT FOR TREADED ROD - VERLÄNGERUNGSMUTTER FÜR GEWINDESTANGE - MANCHON DE RACCORDEMENT DE TIGE FILETÉE			4		
	DRIVE NUT TREADED ROD - EINSHLAGMUTTER FÜR GEWINDESTANGE - ÉCROU A FRAPPER POUR TIGE FILITÉE			4		
	NUT FOR TREADED ROD - MUTTER FÜR GEWINDESTANGE - ÉCROU POUR TIGE FILETÉE			4		
	PLAIN WASHER TREADED ROD - UNTERLEGSCHLEIBE FÜR GEWINDESTANGE - RONDELLE PLATE POUR TIGE FILETÉE			4		
HS1	SCREW FOR GABLE MOULDING - SCHRAUBEN FÜR GIEBELLEISTE - VIS DE FIXATION POUR PLANCHE DE RIVE			120	3.5x50	
	SCREW FOR ROOF EDGE REINFORCEMENT - SCHRAUBEN FÜR DACHRANDVERSTÄRKUNG - VIS POUR RENFORT DE BORD DE TOIT			32	4x40	
	SCREW FOR ROOF BEAMS - SCHRAUBEN FÜR DACHBALKEN - VIS POUR PANNE DE TOIT			15	5x120	
	CYLINDER LOCK - ZYLINDERSCHLOSS - CYLINDRE DE SERRURE			1		
	SCREW FOR 1. WALL BEAM - SCHRAUBE FÜR 1. BOHLENREIHE - VIS DE FIXATION DES FONDATIONS			8	5x90	
	SCREW FOR FUNDAMENT - SCHRAUBEN ZUR BEFESTIGUNG FUNDAMENT - VIS POUR FONDATION			4	5x90	
HS 2	SCREW FOR FIXING GABLE MOULDING DISTANCE SPACERS TO THE WALL SCHRAUBEN FÜR DACHSTÜZEN - VIS DE SUPPORTS EXTENSION TOITURE			8	5x90	
	HAMMER BLOCK - SCHLAGHOLZ - CALLE DE FRAPPE			1		
	SCREW FOR DOORSTEP - SCHRAUBEN FÜR TÜRSCHWELLE - VIS DE FIXATION DU SEUIL DE PORTE			3	4.5x65	
	ZN NAIL FOR ROOFING FELT FILLET - ZN NÄGEL FÜR DACHPAPPENLEISTE - POINTE POUR BAGUETTE FIXATION FEUTRE BITUMEUX			33	2x40	
	ZN NAIL FOR ROOF - ZN NÄGEL FÜR DACHBRETTER - POINTE POUR TOIT			352	2x50	
	DOOR HANDLE FITTINGS - TÜRGRIF - SET DE GARNITURES DE SERRURE DE PORTE			1		

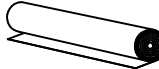
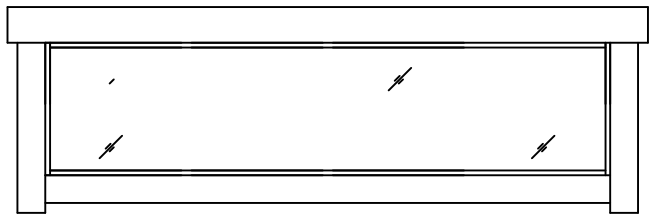
Pos	19.03.2015	Piece list - Stückliste - Liste des pièces Art. Nr. 4412195	8/8	Q.	P (mm)	L (mm)
		SET OF DOOR LOCK COVERS - SCHLOSSBLENDEN - SET DE GARNITURES DE SERRURE DE PORTE		1		
		ROOFING NAILS FOR ROOFING FELT - NÄGEL FÜR DACHPAPPE - POINTE DE FIXATION POUR FEUTRE BITUMEUX		287	2.8x15	
		ROOFING FELT - DACHPAPPE - FEUTRE BITUMEUX		5		6100
				3		15 m2
		WINDOW - FENSTER - FENETRE AK.1.100.MMO.k1500x410 MGC		2		
						
		DOOR - TÜR- PORTE UK.3.030.MVP.MM 835x1957 MGC		1		
		