

Dustin
Art. Nr. 405060
1/8

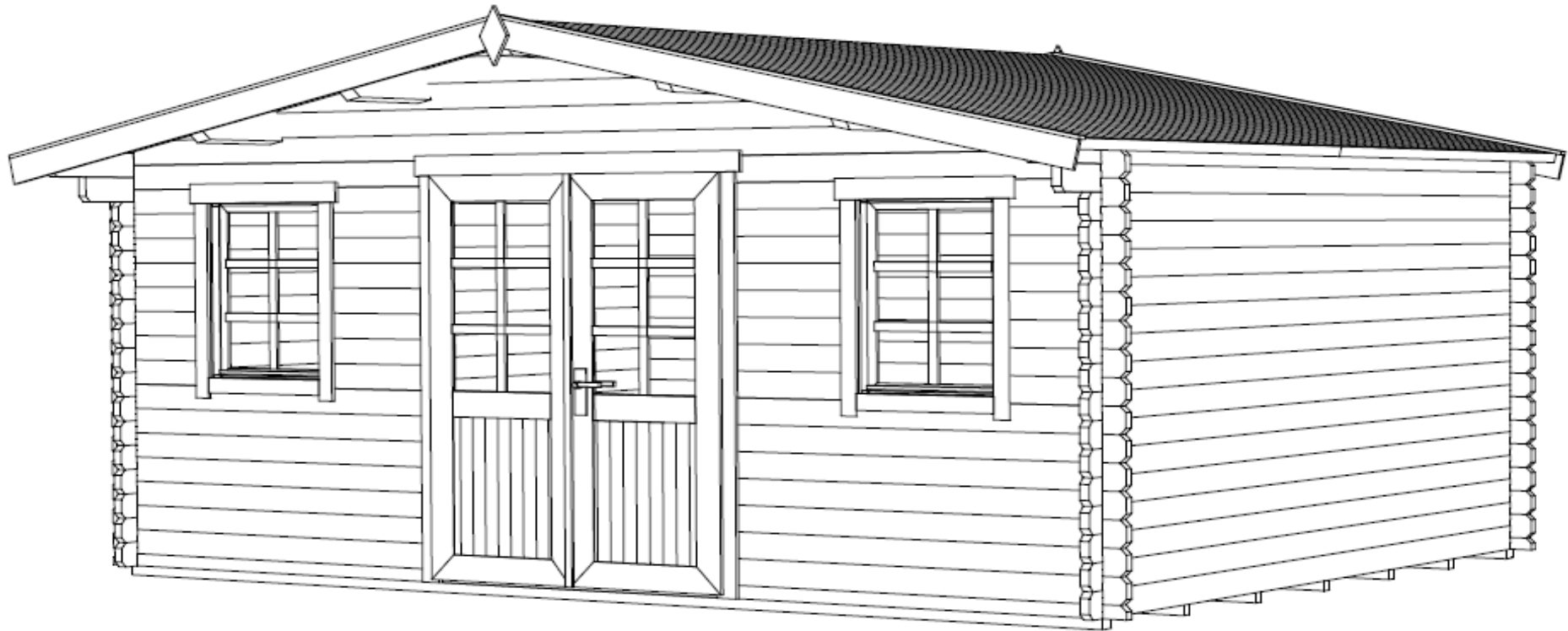

Art.Nr. 405060

GROUNDPLAN - GRUNDPLAN - PLAN DE MASSE

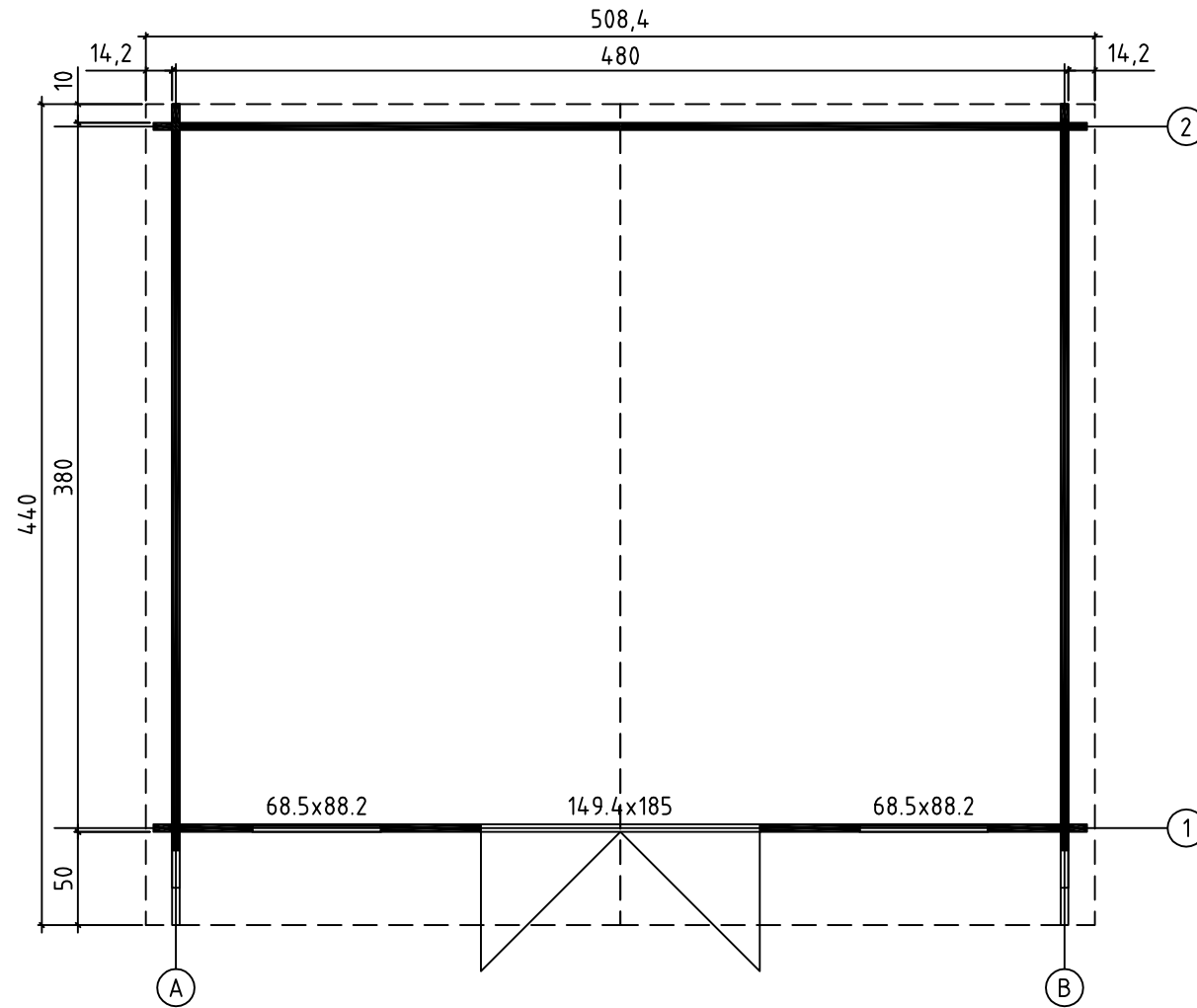

FOUNDATION - FUNDAMENT - FONDATION

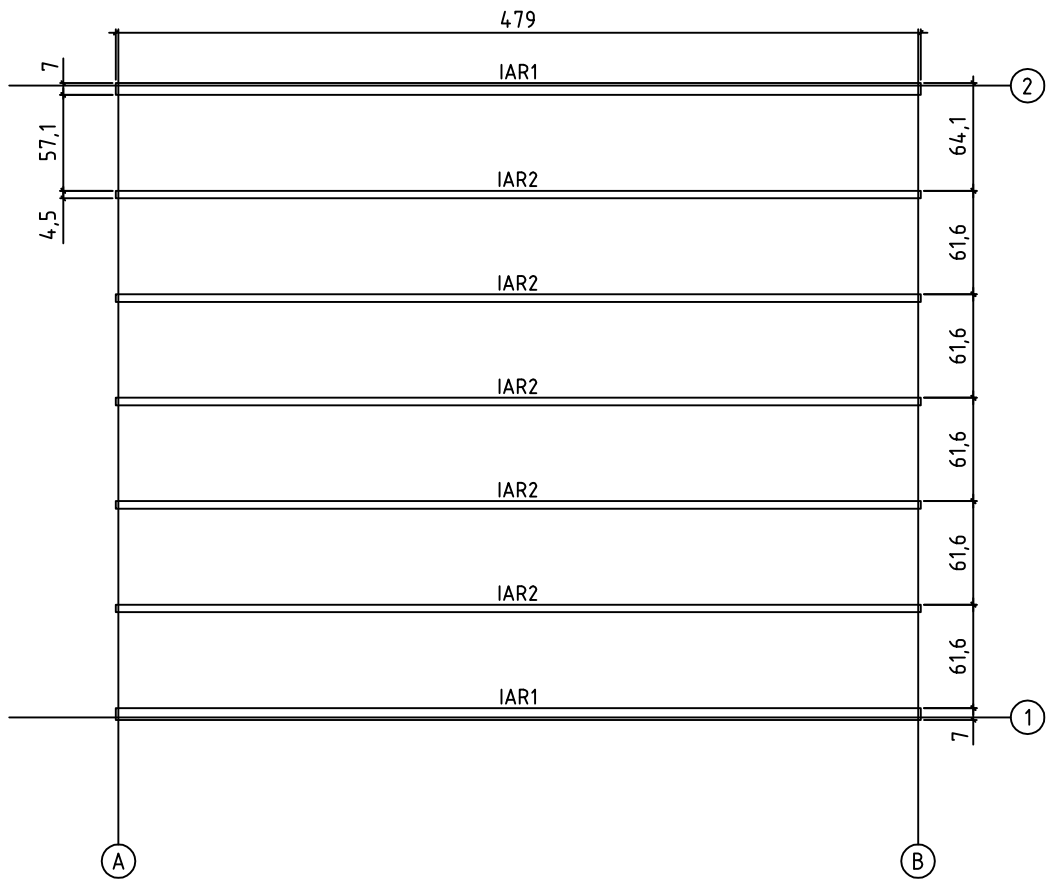



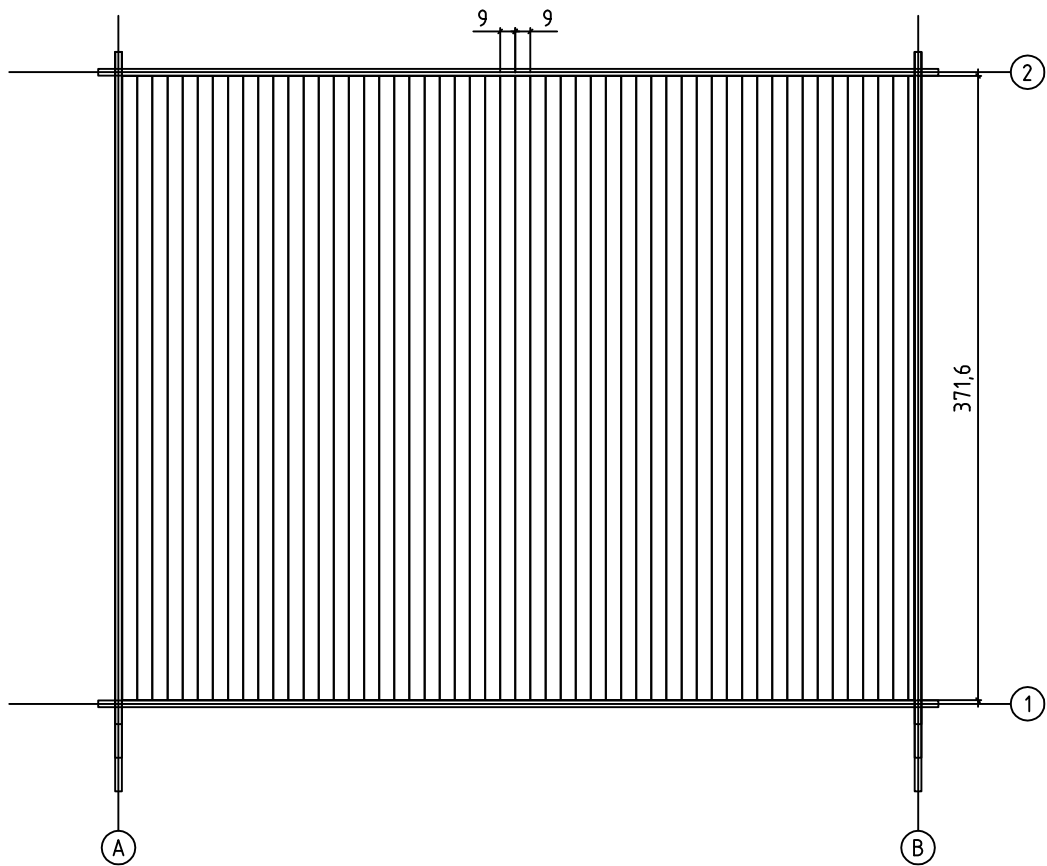

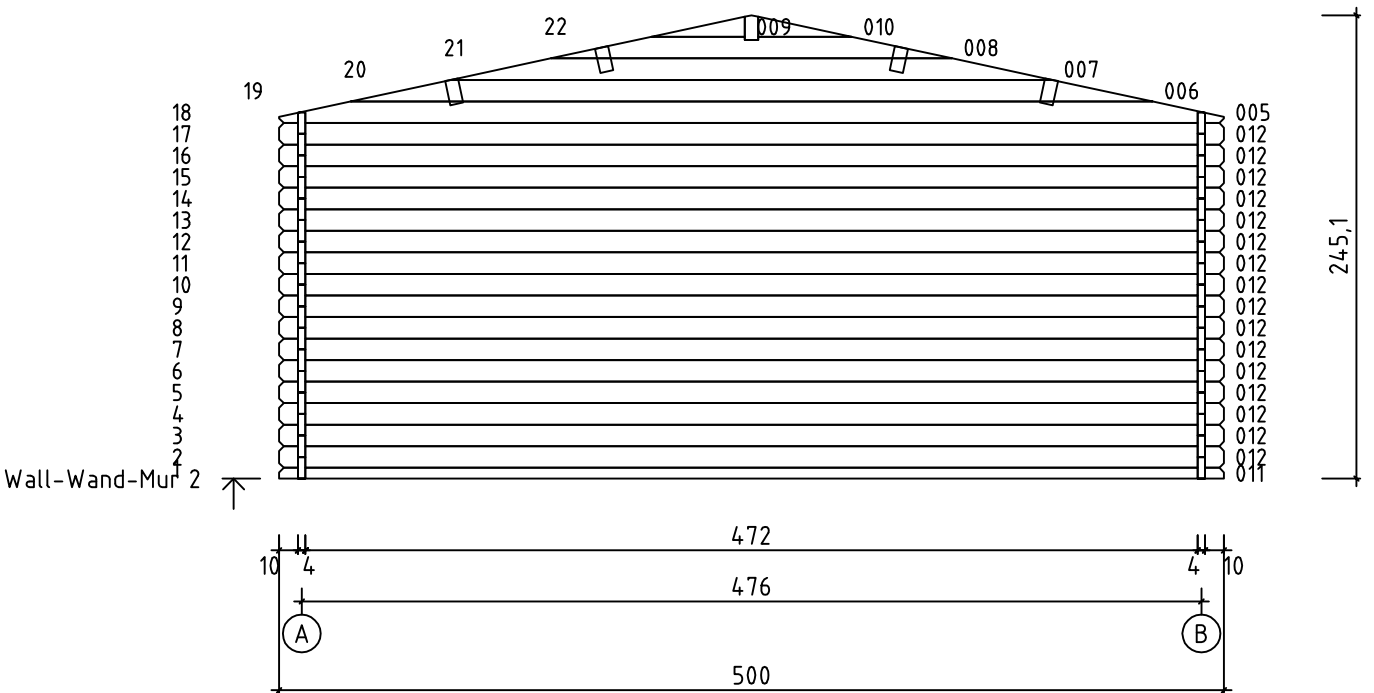
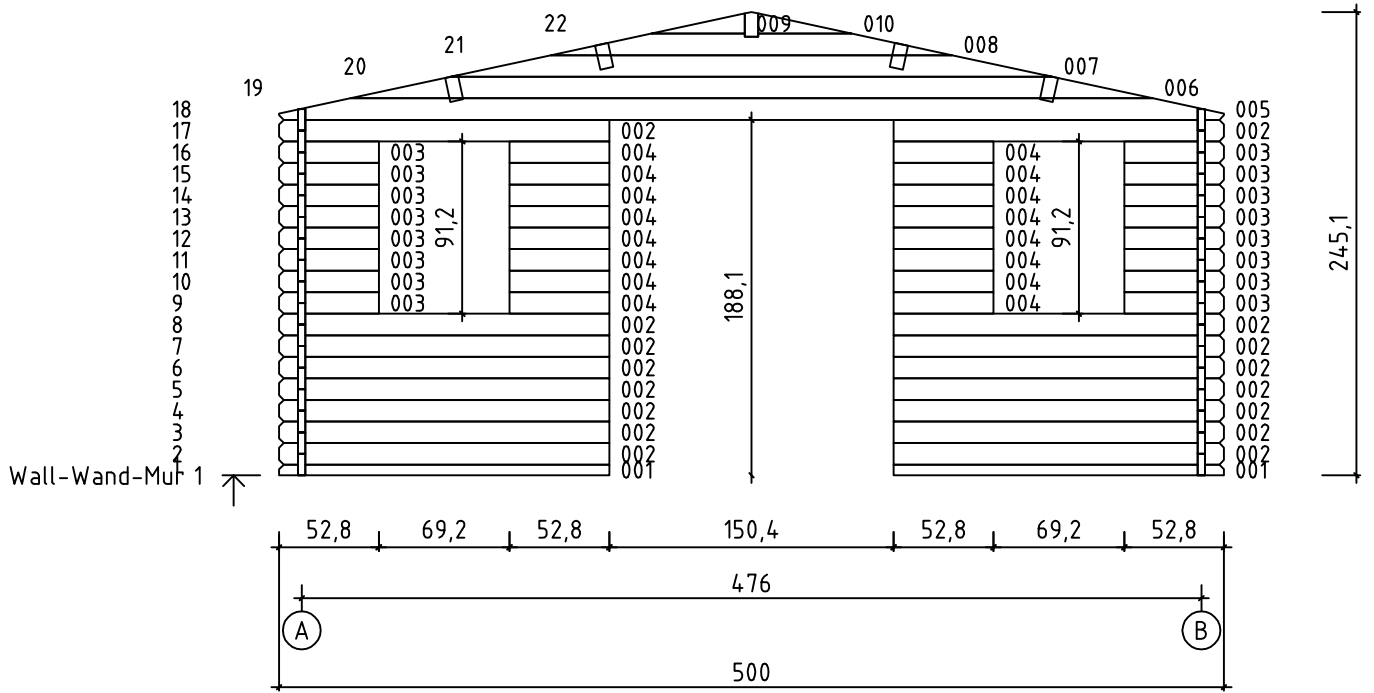

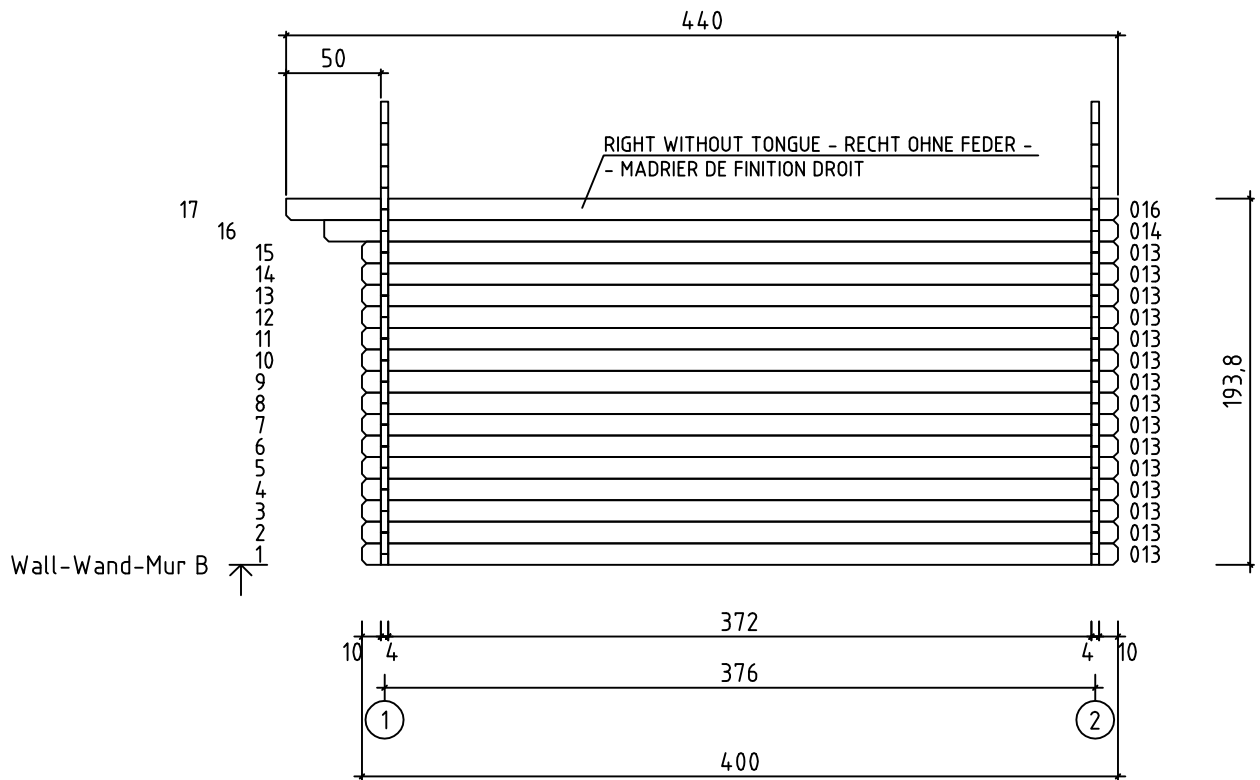
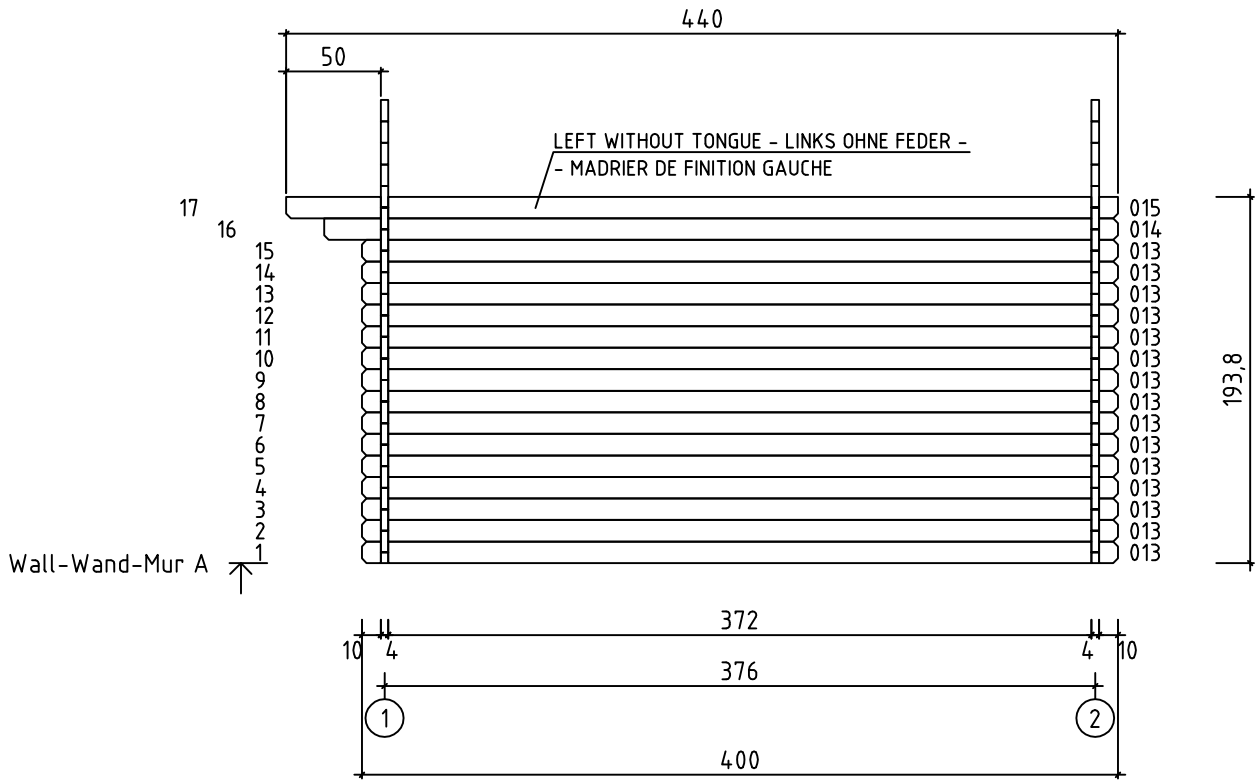



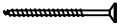
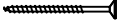
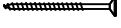
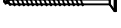



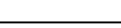
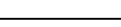
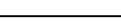
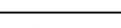

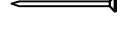
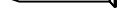
FLOOR BOARDS - FUSSBODENBRETTER - PLAN POSE PLANCHER





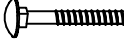

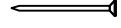
Pos	13.11.2013	Piecelist - Stücklist - Liste des composants Art.Nr. 4.05060	6/8	Q.	P. (mm)	L. (mm)
001				2	40x57	1748
002				16	40x114	1748
003				16	40x114	528
004				16	40x114	528
011				1	40x57	5000
012				16	40x114	5000
013				30	40x114	4000
014				2	40x114	4200
015				1	40x120	4400
016				1	40x120	4400
W1-1 W2-1				1 1		
IAR1	FOUNDATION - FUNDAMENT - FONDATION			2	70x45	4790
IAR2	FOUNDATION - FUNDAMENT - FONDATION			5	45x45	4790
PR1	ROOF BEAM - DACHBALKEN - PANNE DE TOIT			1	70x140	4400
A-PR1	ROOF BEAM - DACHBALKEN - PANNE DE TOIT			4	70x140	4400
	FLOOR BOARDS - FUSSBODENBRETTER - LAME DE PLANCHER			53	90x18	3716
	ROOF BOARDS - DACHBRETTER - VOLIGES			98	90x15	2600
	FLOOR FILLET-FUSSBODENLEISTE - CORNIERE DE FINITION DU PLANCHER				18x18	16.86
	ROOFING FELT FILLET - DACHPAPPENLEISTE - BAGUETTE DE FIXATION DU FEUTRE BITUMEUX			4	15x45	2650
	EAVES BOARD - TRAUFBRETT - BANDEAU DE TOIT			4	15x45	2200
	STORM PROTECTION - STURMLEISTE - - LATTE ANTI-TEMPETE			4	22x45	1900
	GABLE MOULDING - GIEBELLEISTE - - PLANCHE DE RIVE			4	15x120	2650
	WINDOW HANDLE FITTINGS - FENSTERGRIFF - POIGNÉE D'OUVERTURE DE FENETRE			2		
	BOLT FOR WINDOW HANDLE FITTINGS - BOLZEN FÜR FENSTERGRIFF BESCHLAG - BOULON POUR POIGNÉE D'OUVERTURE DE FENETRE			4		

Pos	13.11.2013	Piecelist - Stücklist - Liste des composants Art.Nr. 405060	7/8	Q.	P. (mm)	L. (mm)
		SCREW FOR DOOR JAMB - SCHRAUBE FÜR TÜRRAHMEN - VIS DE FIXATION POUR MONTANT DE PORTE		2	4x60	
		SCREW FOR ROOF BEAMS - SCHRAUBEN FÜR DACHBALKEN - VIS POUR PANNE DE TOIT		14	5x120	
		SCREW FOR 1. WALL BEAM - SCHRAUBE FÜR 1. BOHLENREIHE - VIS DE FIXATION DES FONDATIONS		8	5x90	
		SCREW FOR GABLE SEGMENT - SCHRAUBEN FÜR DECKBLATT - VIS POUR FIXATION LOSANGE DE FINITION		4	3.5x35	
		SCREW FOR GABLE MOULDING - SCHRAUBEN FÜR GIEBELLEISTE - VIS DE FIXATION POUR PLANCHE DE RIVE		32	3.5x50	
		SCREW FOR DOOR FILLET - SCHRAUBE ZUR BEFESTIGUNG TÜRLEISTE - VIS D'ASSEMBLAGE DU CADRE DE PORTE		5	3x30	
HS59		SCREW FOR DOORSTEP - SCHRAUBEN FÜR SWELLE - VIS DE FIXATION DU SEUIL DE PORTE		3	3x30	
		SCREW FOR FIXING BOLT HINGE - SCHRAUBE FÜR TÜRRIGEL - VIS DE FIXATION POUR CHARNIERES ET GONDS DE PORTE		16	4x30	
		SCREW FOR EAVES BOARDS - SCHRAUBEN FÜR TRAUFBRETTEN - VIS DE FIXATION POUR BANDEAU DE TOIT		20	4x40	
		SCREW FOR FIXING BOLT HINGE - SCHRAUBE FÜR TÜRRIGEL - VIS DE FIXATION POUR CHARNIERES ET GONDS DE PORTE		12	4x40	
		SCREW FOR DOOR JAMB - SCHRAUBE FÜR TÜRRAHMEN - VIS DE FIXATION POUR MONTANT DE PORTE		2	5x90	
		ZN NAIL FOR FLOOR FILLET - ZN NÄGEL FÜR FUSSBODENLEISTE - POINTE POUR CORNIERE DE FINITION DU PLANCHER		34	1.4x40	
		HAMMER BLOCK - SCHLAGHOLZ - CALLE DE FRAPPE		1		
		NAIL FOR WINDOW/DOOR CROSS SLOT STRAIGHT - NÄGEL FÜR FENSTER/TÜREN EISENWAREN - POINTE POUR QUINCAILLERIE POUR PORTES ET FENETRES		48	1.4x30	
		ZN NAIL FOR FLOOR - ZN NÄGEL FÜR FUSSBODENBRETTEN - CLOUS POUR PLANCHER		378	2x50	
		ZN NAIL FOR ROOFING FELT FILLET - ZN NÄGEL FÜR DACHPAPPENLEISTE - POINTE POUR BAGUETTE FIXATION FEUTRE BITUMEUX		24	2x40	
		WINDOW/DOOR CROSS SLOT STRAIGHT (PLASTIC) - FENSTER/TÜREN EISENWAREN - QUINCAILLERIE POUR PORTES ET FENETRES		24		
		LATCH BOLT FOR DOUBLE DOOR - TORRIEGEL - LOQUET POUR DOUBLE PORTE		2	90 mm	
		GABLE SEGMENT - DECKBLATT - LOSANGE DE FINITION		2		
		NUT FOR STORM PROTECTION - SCHRAUBENMUTTER FÜR STURMLEISTE - ÉCROU POUR LAME ANTI-TEMPETE		8	D6	
		BOLT FOR STORM PROTECTION - BOLZEN FÜR STURMLEISTE - VIS POUR LAME ANTI-TEMPETE		8	6x70	
		WASHER FOR STORM PROTECTION - DICHTSCHEIBE FÜR STURMLEISTE - RONDELLE POUR LAME ANTI-TEMPETE		8	D6	
		ZN NAIL FOR ROOF - ZN NÄGEL FÜR DACHBRETTEN - POINTES DE FIXATIONS DES VOLIGES DE TOIT		412	2x50	
		SET OF DOOR LOCK COVERS - SCHLOSSBLENDEN - SET DE GARNITURES DE SERRURE DE PORTE		1		
		MALE BOLT HINGE FOR DOOR - TÜRRIEGEL - PARTIE MALE DE CHARNIERE DE PORTE		4	DIN15-57	

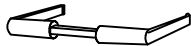
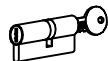
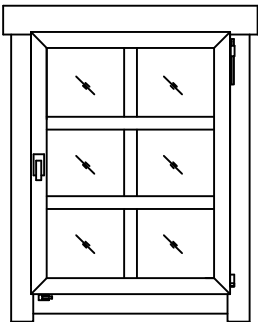
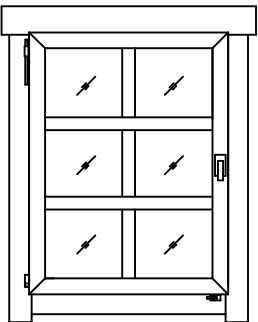
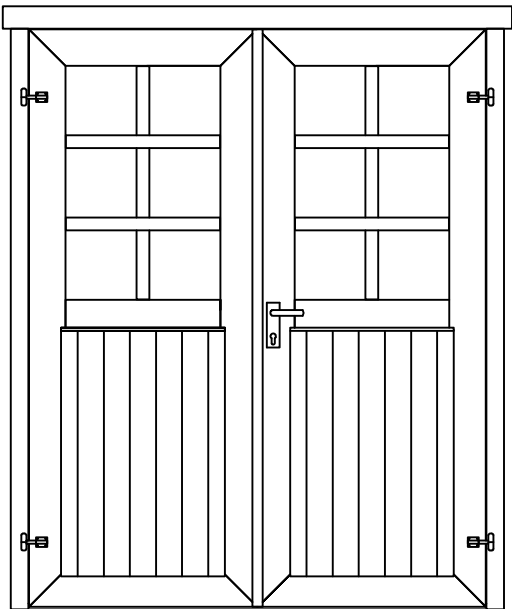
Pos	13.11.2013	Piecelist - Stücklist - Liste des composants Art.Nr. 405060	8/8	Q.	P. (mm)	L. (mm)
	DOOR HANDLE FITTINGS - TÜRGRIF - SET DE GARNITURES DE SERRURE DE PORTE			1		
	CYLINDER LOCK - ZYLINDERSCHLOSS - CYLINDRE DE SERRURE			1	30x30	
	WINDOW - FENSTER - FENETRE 685x882 SGC		AK.1.106.SSP.Pd	1		
						
	WINDOW - FENSTER - FENETRE 685x882 SGC		AK.1.106.SSV.Pd	1		
						
	DOOR - TÜR - PORTE 1494x1850 SGA+GL28		TUK.2.056.SVP.MXPG40	1		
						

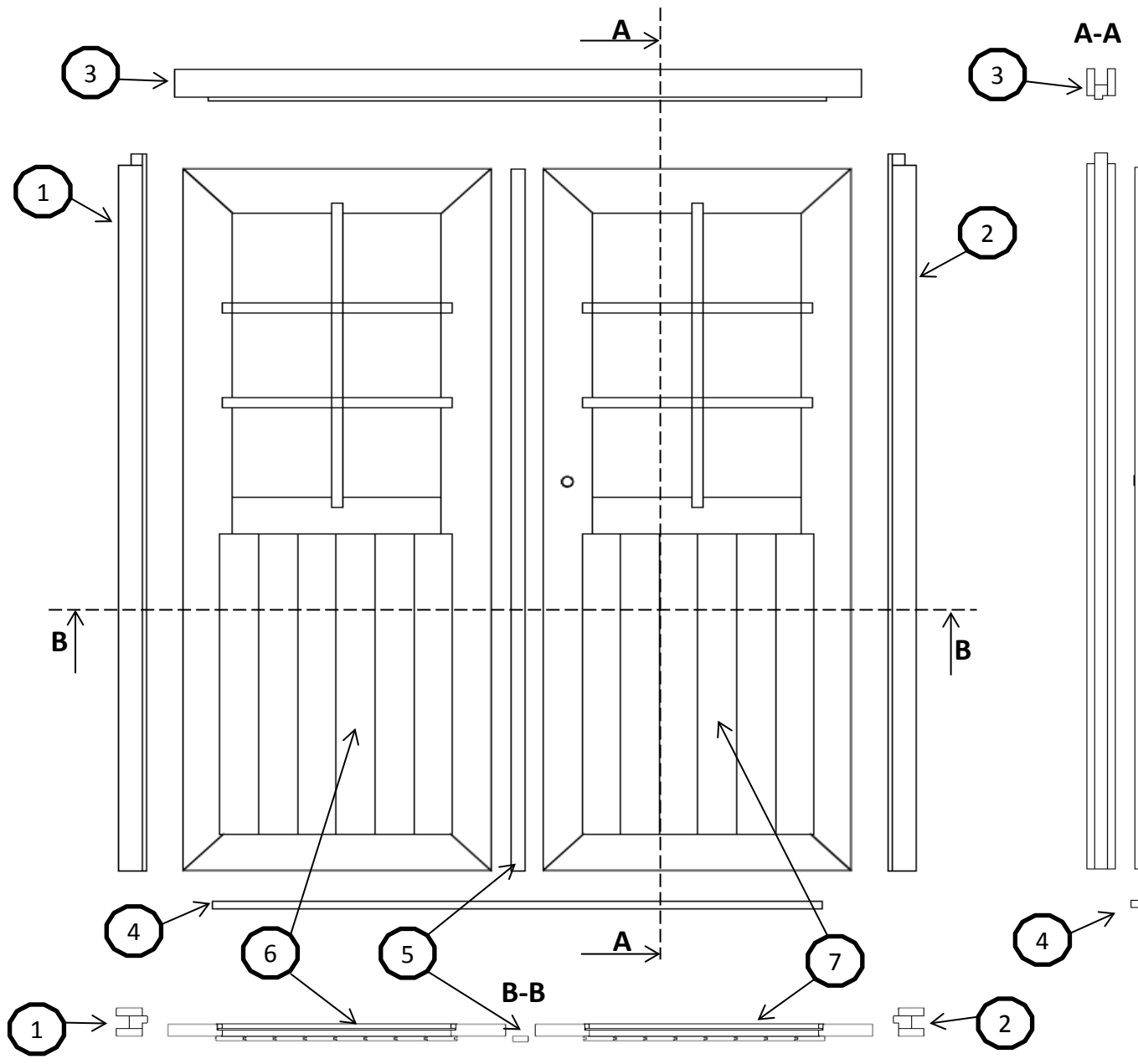

Pos.	Q.	Dimensions
1	1	65 mm x 77 mm
2	1	65 mm x 77 mm
3	1	100 mm x 77 mm
4	1	29 mm x 18 mm
5	1	32 mm x 13 mm
6	1	716 mm
7	1	716 mm

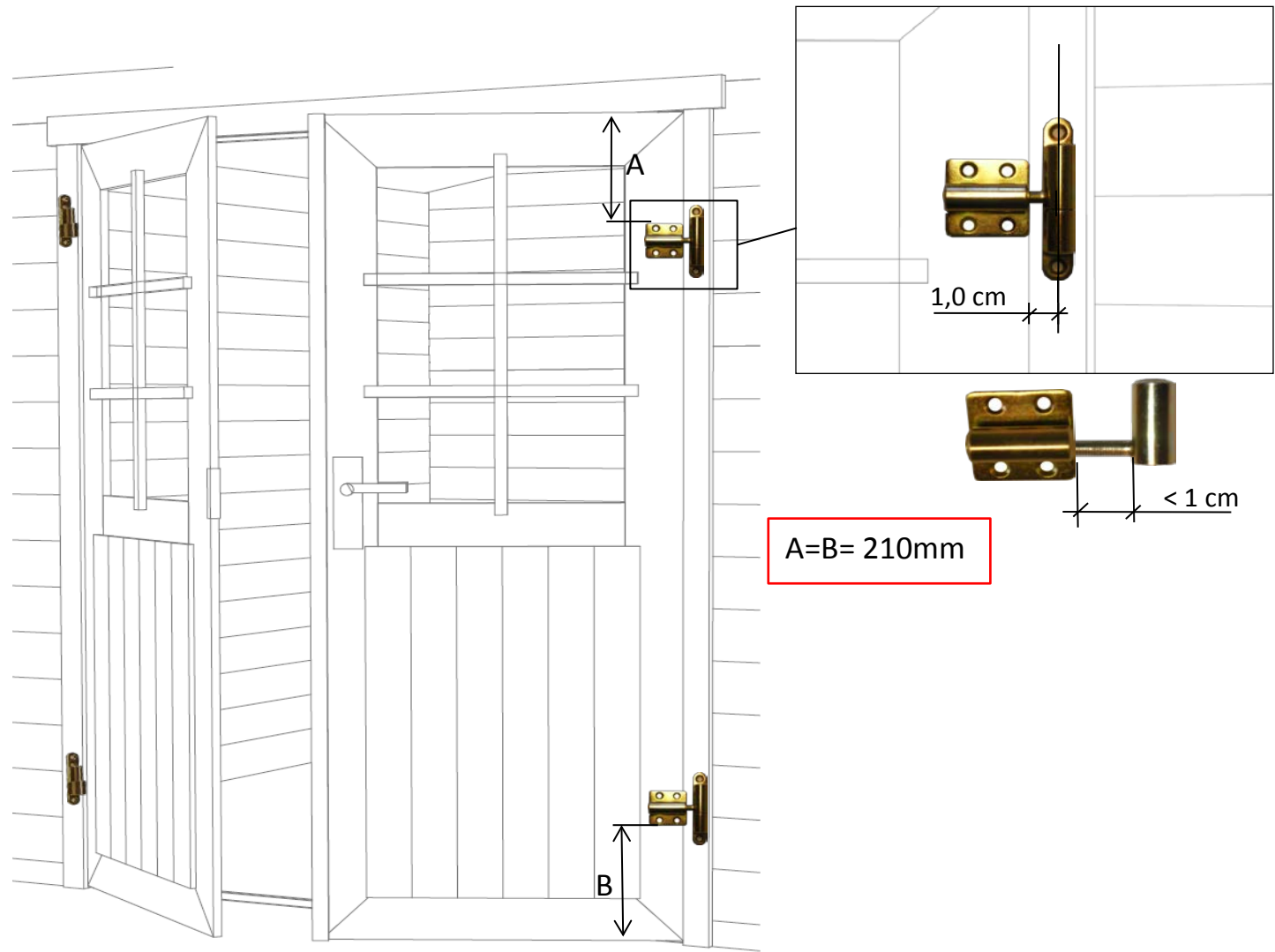

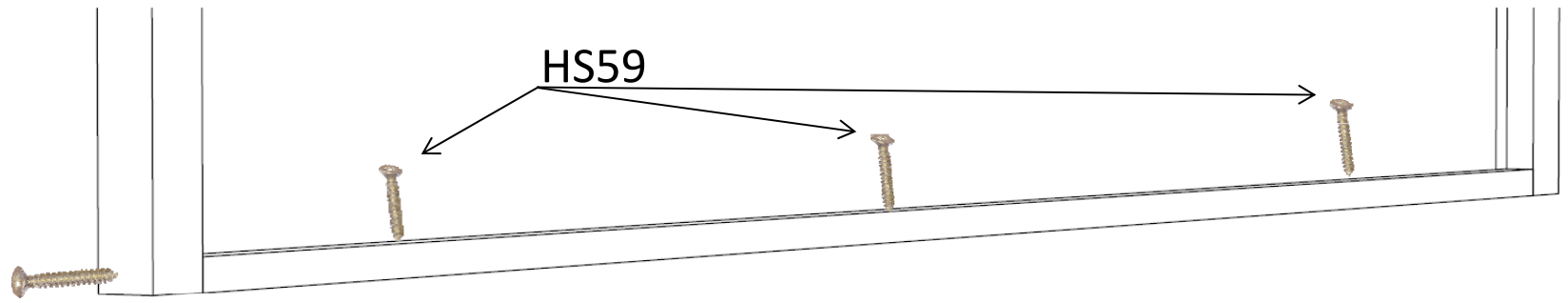

4,0x60mm

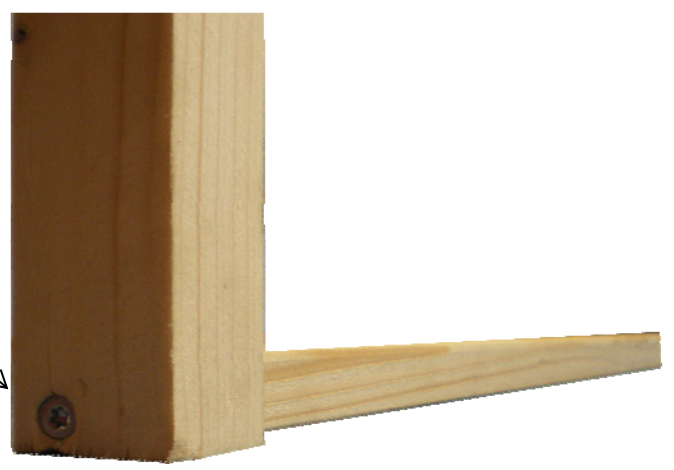

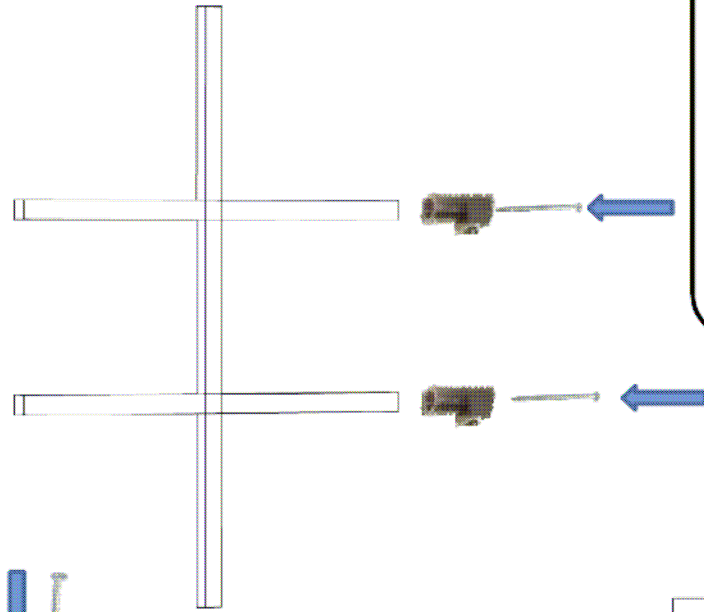
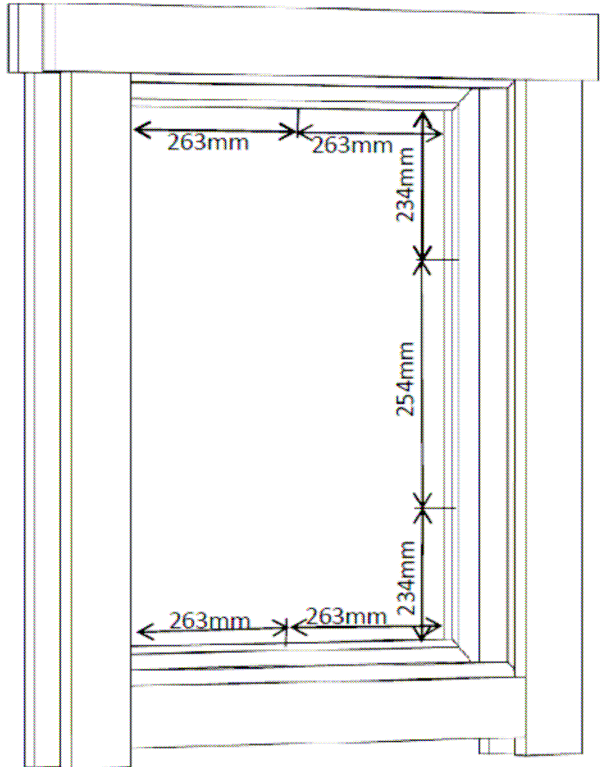

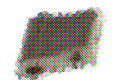
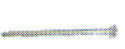
-  -6pcs
-  -6pcs
-  -12pcs

