

Jasmin
Art. Nr. 4420302

1/11

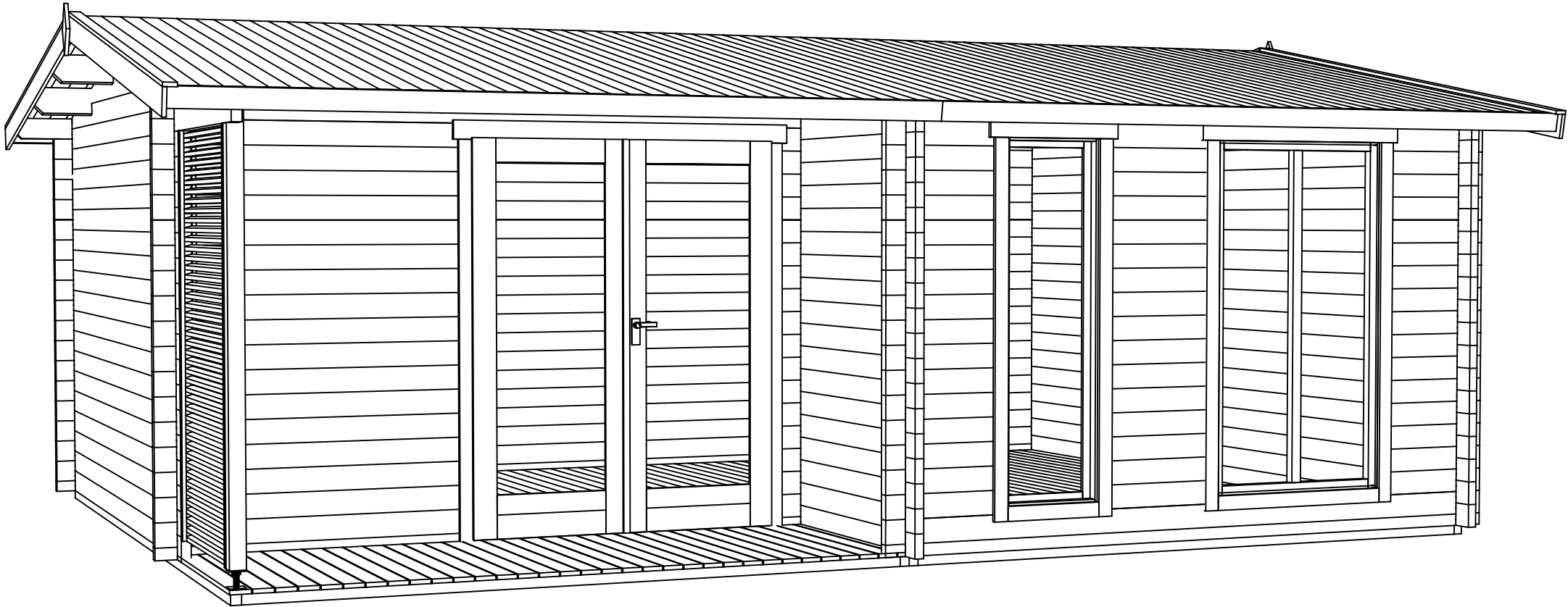

12.01.2016

Art.Nr. 4420302
GROUNDPLAN - GRUNDPLAN - PLAN DE MASSE

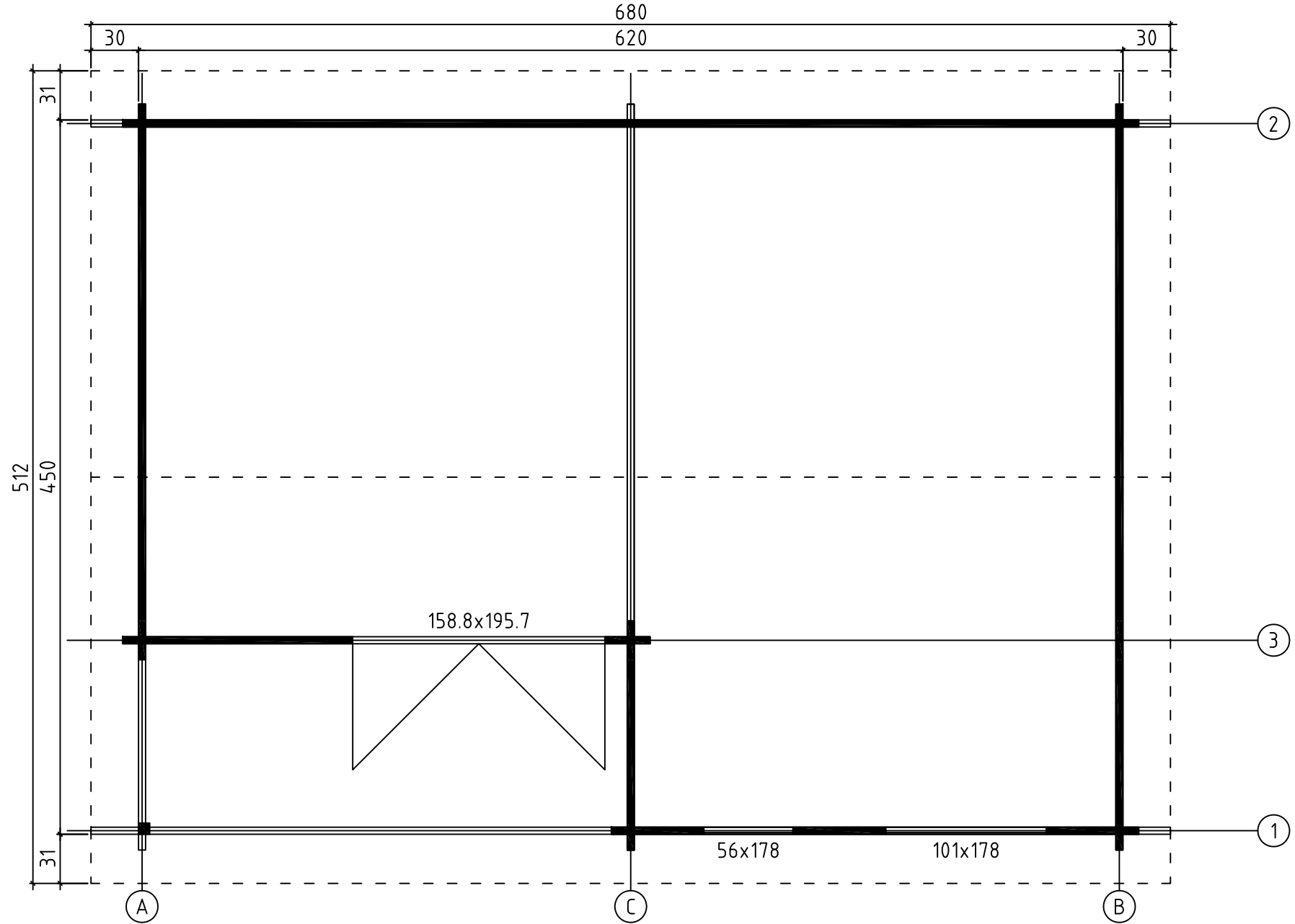

Art.Nr. 4420302
 FOUNDATION - FUNDAMENT - FONDATION

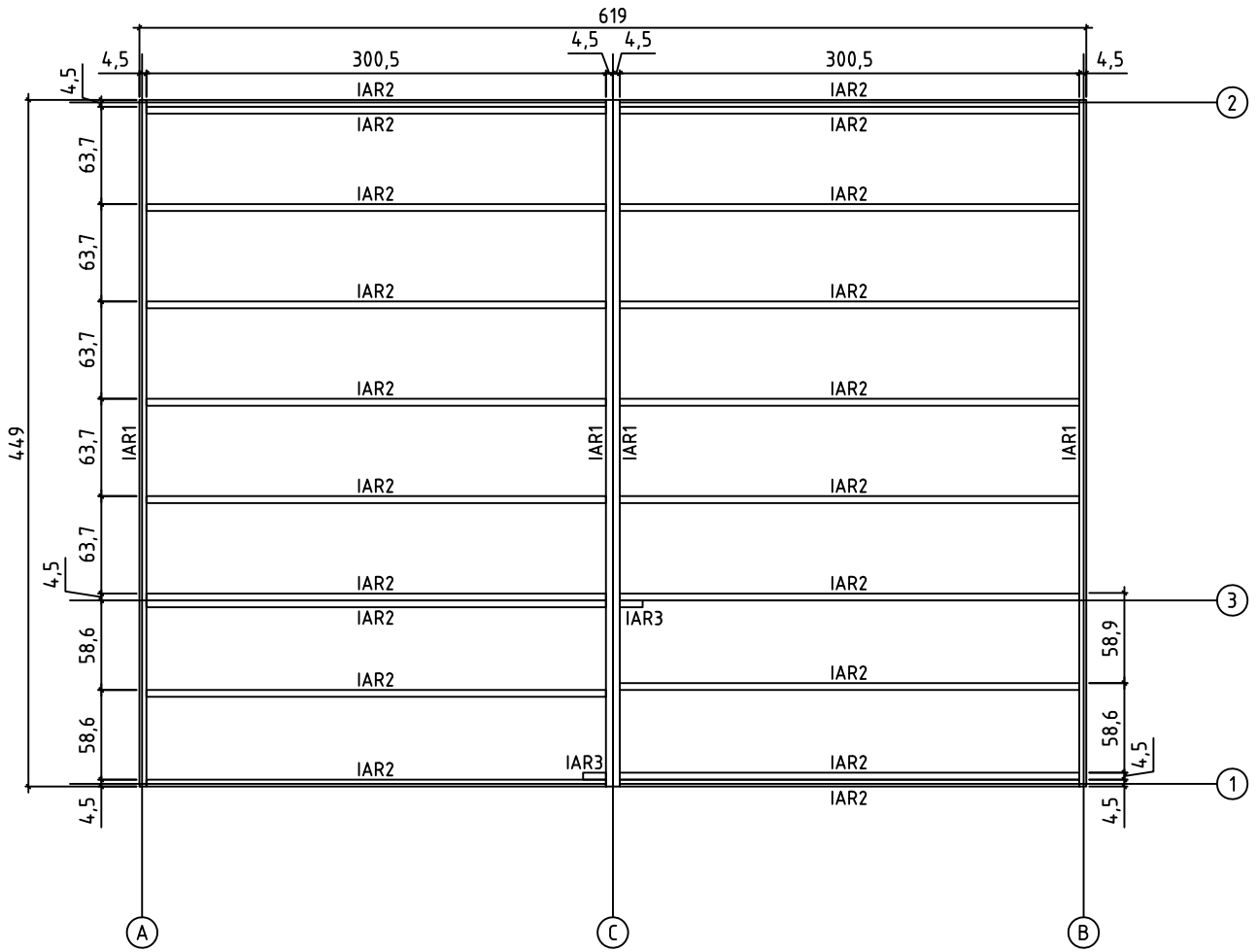

FLOOR BOARDS - FUSSBODENBRETTER - LAME DE PLANCHER
 TERRACE BOARDS - TERRASSENBRETTER - PLANCHER DE TERRASSE

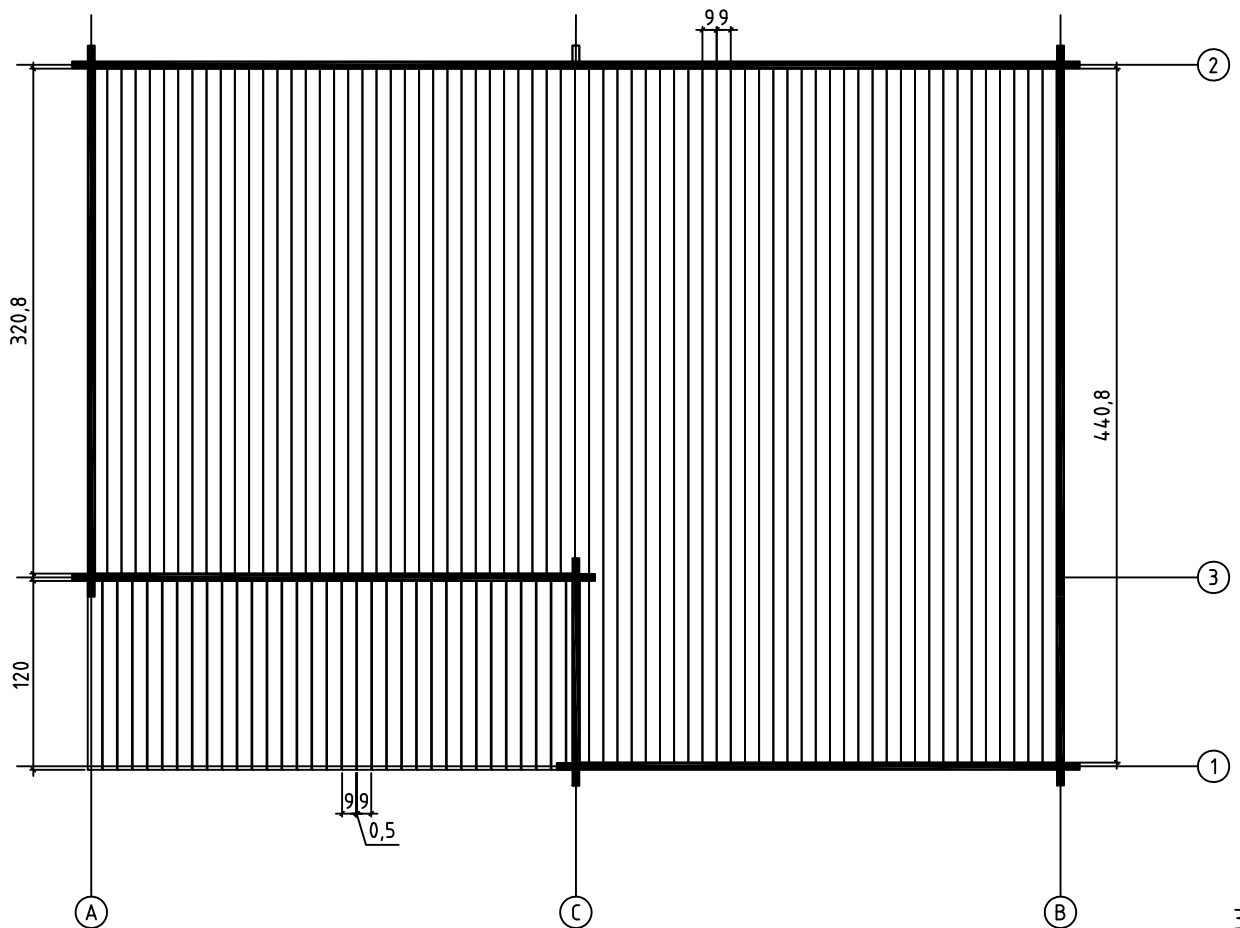

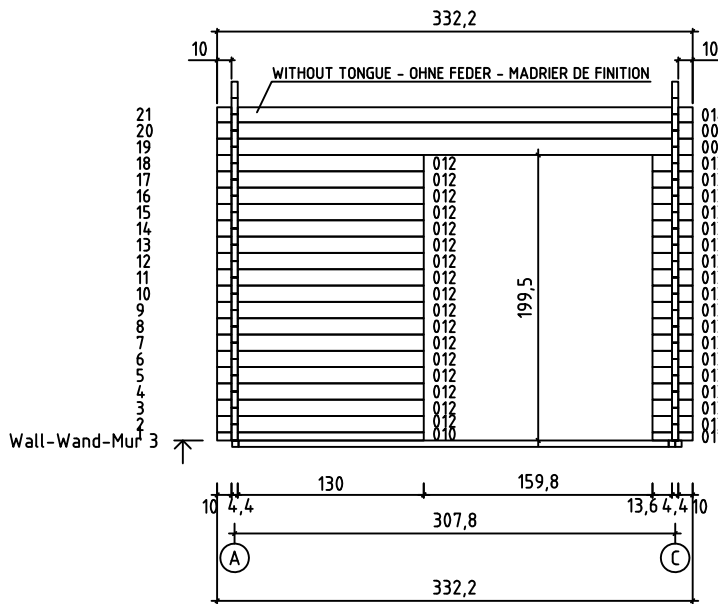
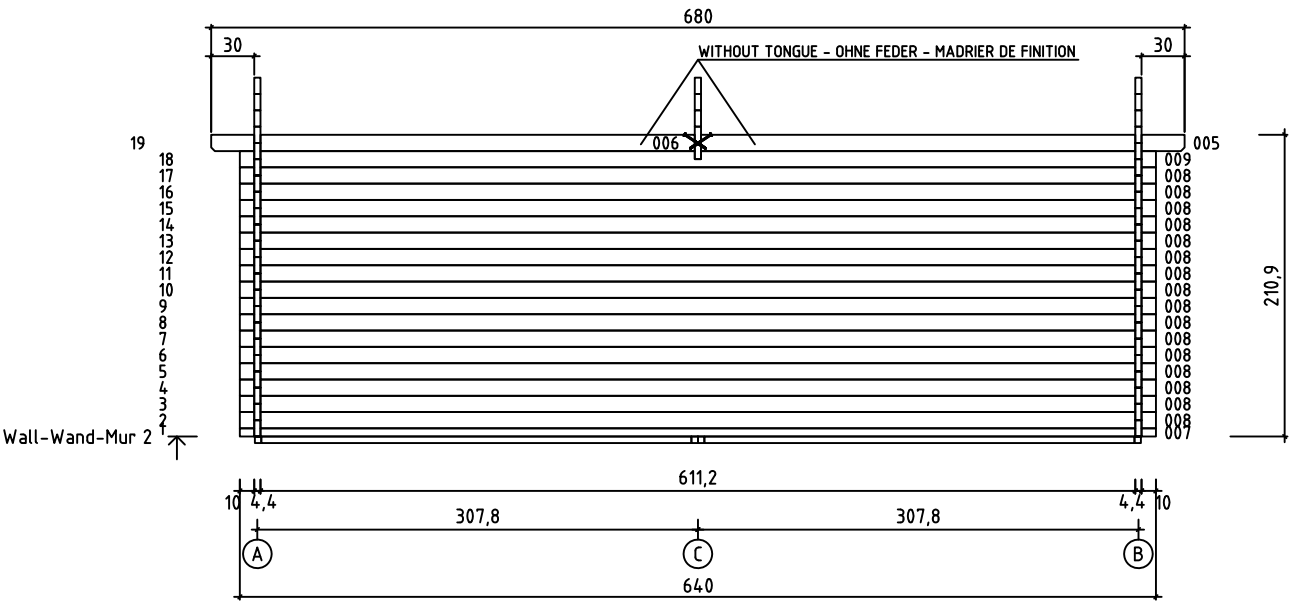
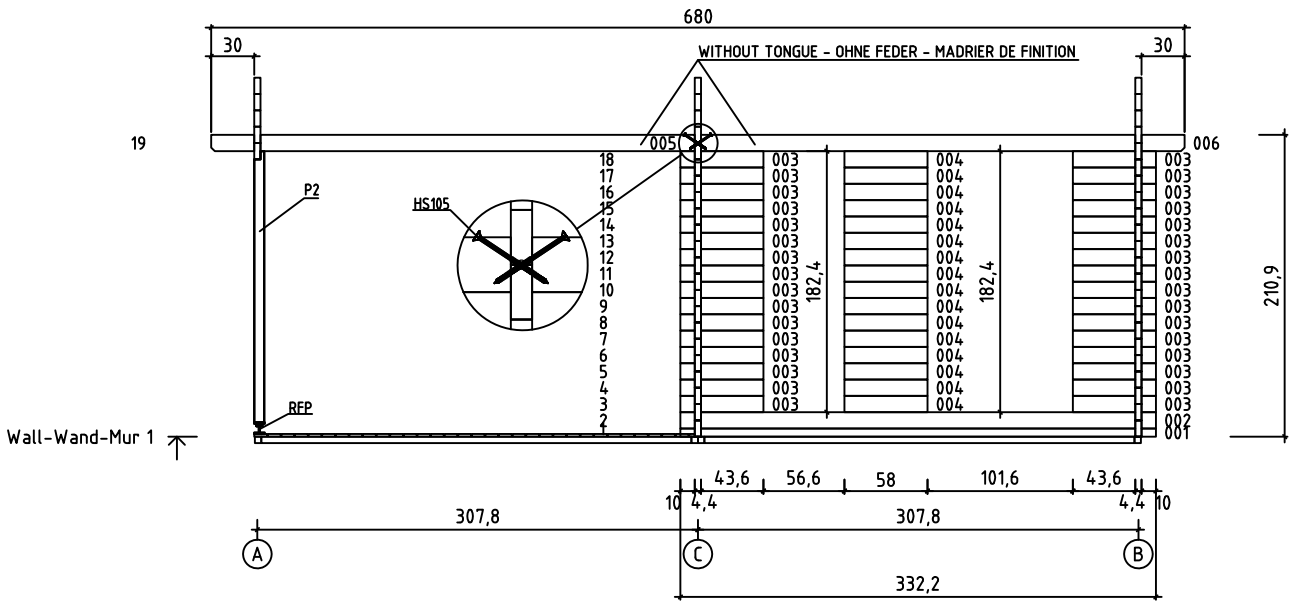

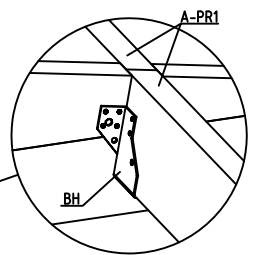
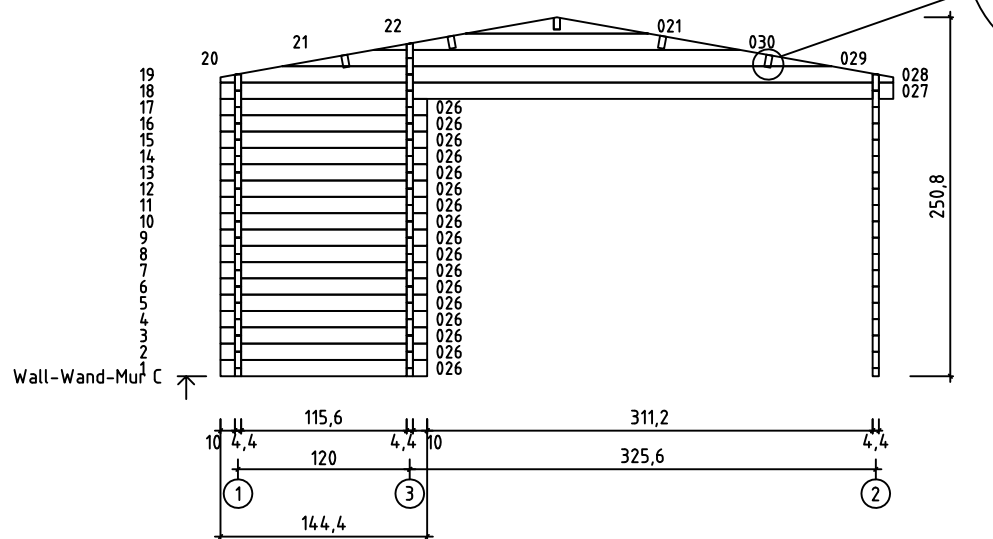
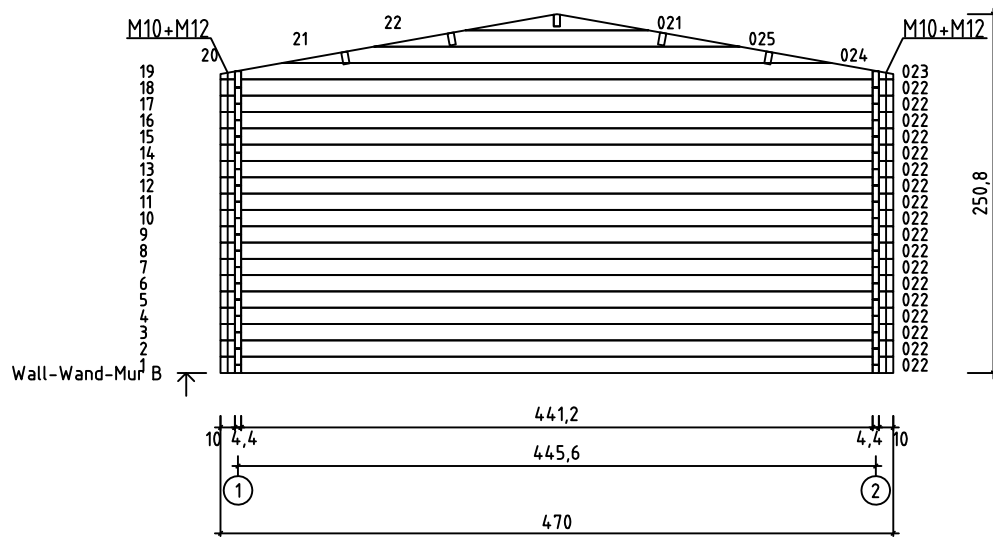
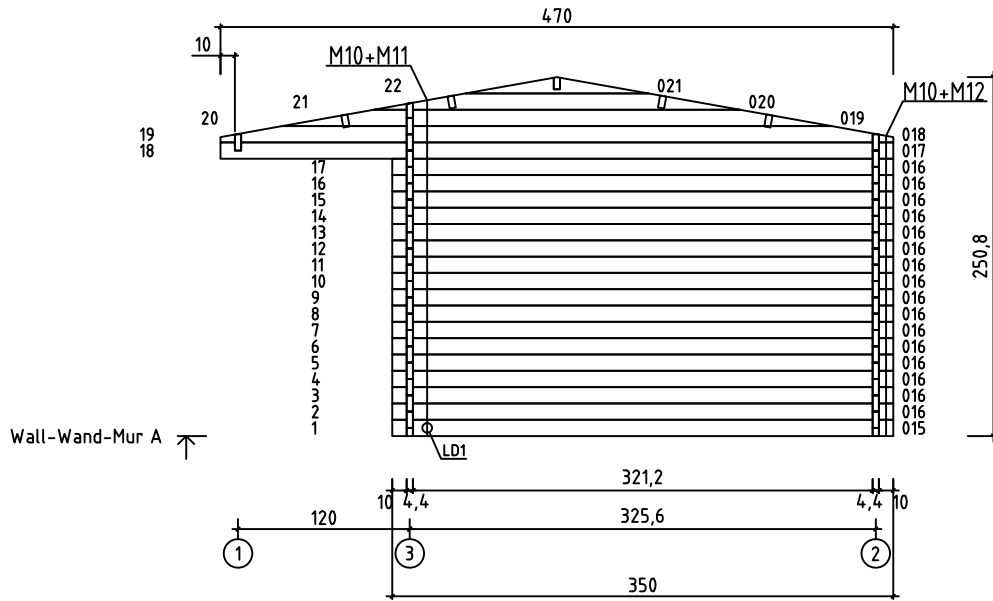

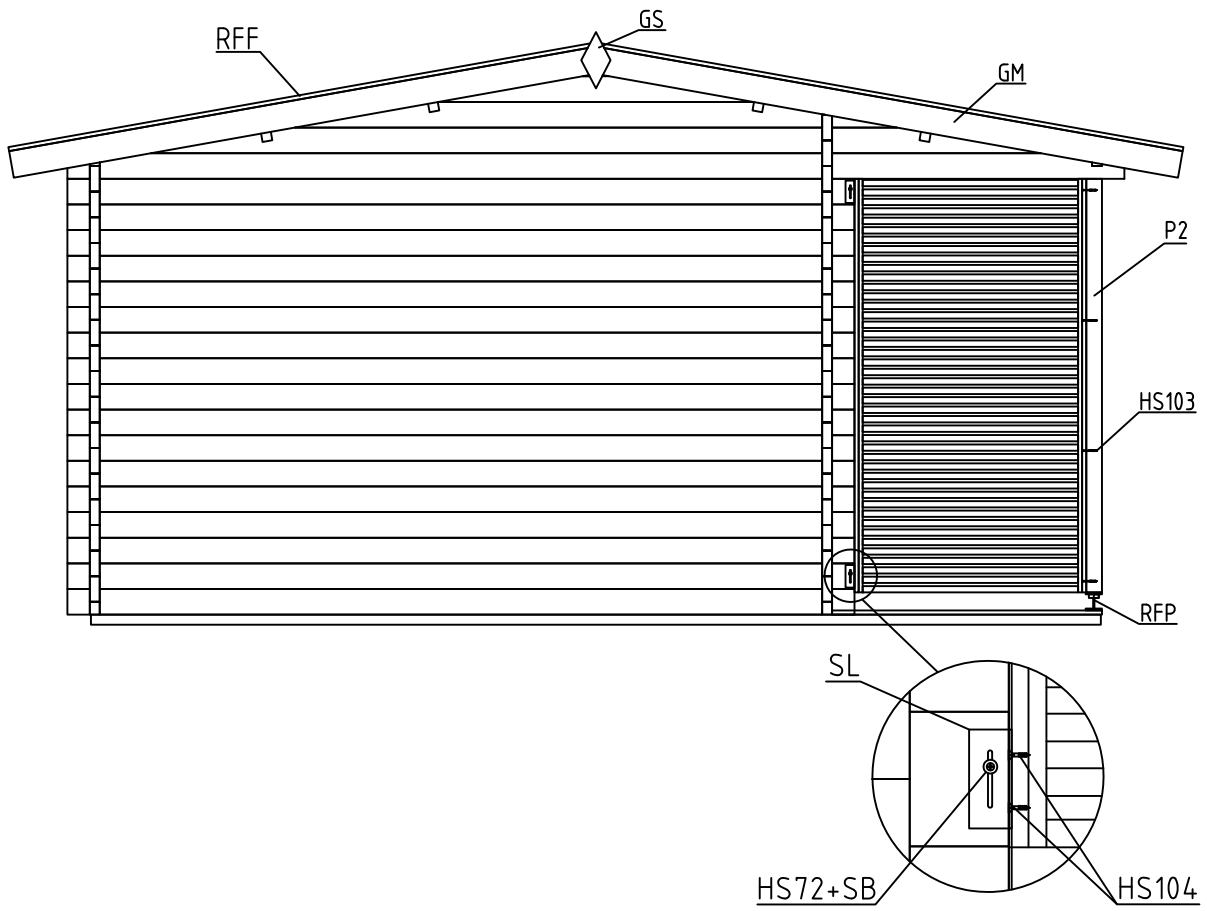



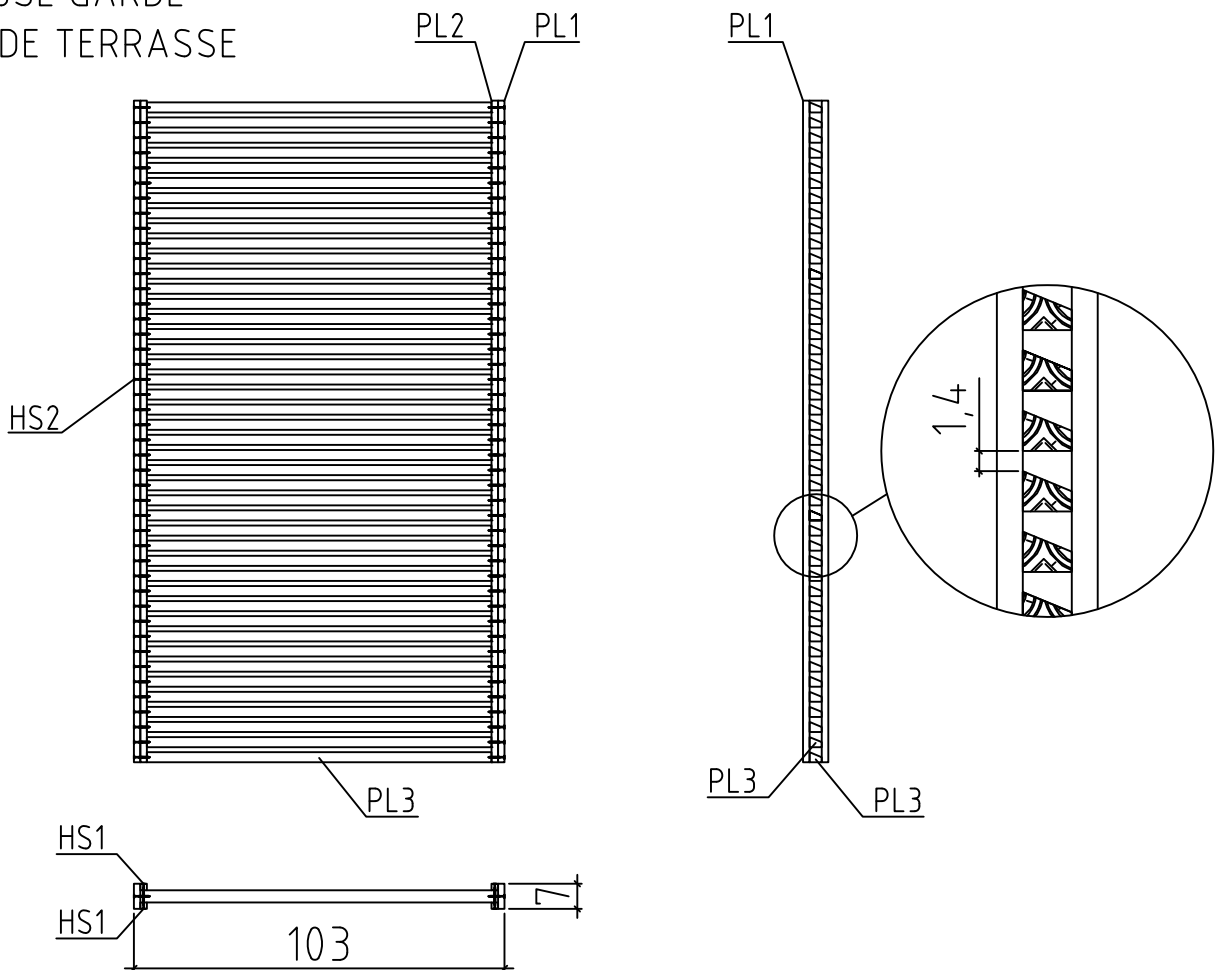

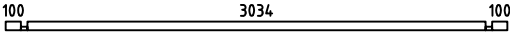
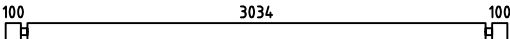

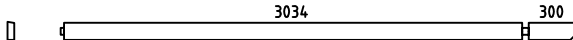
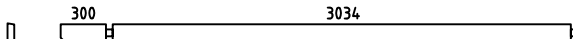
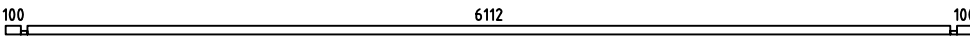
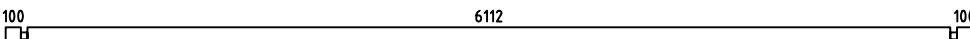
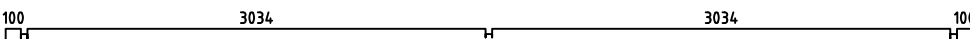
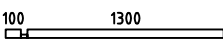

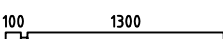

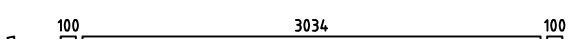
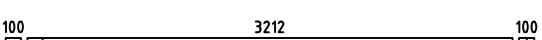
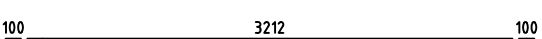
TERRACE RAILING -
TERRASSE GARDE -
CORPS DE TERRASSE

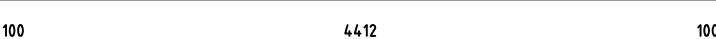

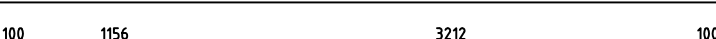
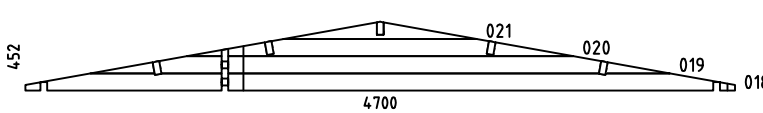
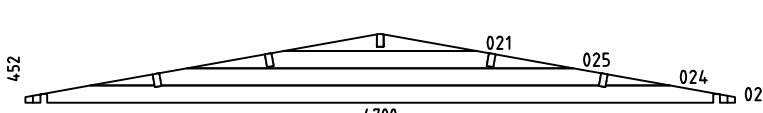
Pos	12.01.2015	Piece list - Stückliste - Liste des pièces Art.Nr. 4420302	7/11	Q	P (mm)	L (mm)
001				1	44x57	3322
002				3	44x114	3322
003				32	44x114	580
004				16	44x114	580
005				2	44x120	3400
006				2	44x120	3400
007				1	44x57	6400
008				16	44x114	6400
009				1	44x114	6400
010				1	44x57	1444
011				1	44x57	280
012				17	44x114	1444
013				17	44x114	280
014				1	44x106	3322
015				1	44x114	3500
016				16	44x114	3500
017				1	44x114	4700
022				18	44x114	4700
026				17	44x114	1444
027				1	44x114	4700
WA-1				1		
WB-1				1		

Pos	12.01.2015	Piece list - Stückliste - Liste des pièces Art.Nr. 4420302	8/11	Q	P (mm)	L (mm)
WC-1				1		
IAR1		FOUNDATION - FUNDAMENT - FONDATION 		4	45x45	4490
IAR2		FOUNDATION - FUNDAMENT - FONDATION 		20	45x45	3005
IAR3		FOUNDATION - FUNDAMENT - FONDATION 		2	45x45	150
PR1		ROOF BEAM - DACHBALKEN - PANNE DE TOIT 		2	44x140	3400
A-PR1		ROOF BEAM - DACHBALKEN - PANNE DE TOIT 		8	44x140	3400
		FLOOR BOARDS - FUSSBODENBRETTER - LAME DE PLANCHER 		34	90x18	4408
		FLOOR BOARDS - FUSSBODENBRETTER - LAME DE PLANCHER 		34	90x18	3208
		TERRACE BOARDS - TERRASSENBRETTER - PLANCHER DE TERRASSE 		33	90x19	1200
		ROOF BOARDS - DACHBRETTER - VOLIGES 		152	90x18	2600
		FLOOR FILLET - FUSSBODENLEISTE - CORNIERE DE FINITION DU PLANCHER 			18x18	21.03
RFF		ROOFING FELT FILLET - DACHPAPPENLEISTE - BAGUETTE DE FIXATION DU FEUTRE BITUMEUX 		4	18x58	2650
M12		TREADED ROD M10 - GEWINDESTANGE M10 - TIGE FILETÉE M10 		3		130
M11		TREADED ROD M10 - GEWINDESTANGE M10 - TIGE FILETÉE M10 		1		290
M10		TREADED ROD M10 - GEWINDESTANGE M10 - TIGE FILETÉE M10 		4		2000
PL1		FILLE FOR TERRACE RAILING - LEISTE FÜR TERRASSE - BAGUETTE POUR CORPS DE TERRASSE 		4	18x18	1839
PL2		FILLE FOR TERRACE RAILING - LEISTE FÜR TERRASSE - BAGUETTE POUR CORPS DE TERRASSE 		2	18x70	1839
PL3		FILLE FOR TERRACE RAILING - LEISTE FÜR TERRASSE - BAGUETTE POUR CORPS DE TERRASSE 		44	28x34	994
P2		POST - PFOSTEN - POTEAU 		1	70x70	1896
TB		FASCIA BOARD - TRAUFBRETT - BANDEAU DE TOIT 		4	18x90	3400
DRV		ROOF EDGE REINFORCEMENT - DACHRANDVERSTÄRKUNG - CORNIERE DE RENFORT DE BORD DE TOIT 		4	28x34	3400
GM		GABLE MOULDING - GIEBELLEISTE - PLANCHE DE RIVE 		4	18x120	2650
FS		WINDOW HANDLE FITTINGS - FENSTERGRIFF - POIGNEE DE FENETRE 		2		
		BOLT FOR WINDOW HANDLE FITTINGS - BOLZEN FÜR FENSTERGRIFF BESCHLAG - VIS POUR FIXATION POIGNEE DE FENETRE 		4		

Pos	12.01.2015	Piece list - Stückliste - Liste des pièces Art.Nr. 4420302	9/11	Q	P (mm)	L (mm)
LD1		LID FOR TREADED ROD HOLE - ABDECKUNG FÜR GEWINDESTANGENÖFFNUNG - COUVERCLE POUR ACCES REGLAGE TIGE FILETÉE		1		
		LENGTHENING BOLT FOR TREADED ROD - VERLÄNGERUNGSMUTTER FÜR GEWINDESTANGE - MANCHON DE RACCORDEMENT DE TIGE FILETÉE		4	D10	
HS104		SCREW FOR SLIDING WALL TIE - SCHIEBEREGLER FÜR WAND - SABOT MÉTALLIQUE POUR FIXATION MUR		8	3.5x20	
HS12		SCREW FOR GABLE SEGMENT - SCHRAUBEN FÜR DECKBLATT - VIS POUR FIXATION LOSANGE DE FINITION		4	3.5x35	
		SCREW FOR POST - SCHRAUBEN FÜR PFOSTEN - VIS DE FIXATION DES POTEAUX		2	3.5x50	
HS16		SCREW FOR GABLE MOULDING - SCHRAUBEN FÜR GIEBELLEISTE - VIS POUR FIXATION PLANCHE DE RIVE		32	3.5x50	
HS1		SCREW FOR FIXING TERRACE RAILING - SCHRAUBE FÜR TERRASSE VIS DE FIXATION DE GARDE-CORPS DE TERRASSE		20	3x30	
HS3		SCREW FOR DOOR FILLET - SCHRAUBE ZUR BEFESTIGUNG TURLEISTE - VIS POUR FIXATION BAGUETTE D'ARRET DE PORTE		5	3x30	
HS103		SCREW FOR FIXING TERRACE RAILING - SCHRAUBE FÜR TERRASSE VIS DE FIXATION DE GARDE-CORPS DE TERRASSE		4	4.5x80	
HS2		SCREW FOR FIXING TERRACE RAILING - SCHRAUBE FÜR TERRASSE VIS DE FIXATION DE GARDE-CORPS DE TERRASSE		88	4x40	
HS32		SCREW FOR FASCIA BOARDS - SCHRAUBEN FÜR TRAUFBRETTER - VIS POUR FIXATION BANDEAU DE TOIT		32	4x40	
		SCREW FOR ROOF EDGE REINFORCEMENT - SCHRAUBEN FÜR DACHRANDVERSTÄRKUNG - VIS POUR FIXATION CORNIERE RENFORT DE BORD DE TOIT		32	4x40	
		SCREW FOR BEAM HOLDER - SCHRAUBEN FÜR BALKENHALTER - VIS DE FIXATION SUPPORT "U" GALVANISÉ		120	4x40	
HS43		SCREW FOR ROOF BEAMS - SCHRAUBEN FÜR DACHBALKEN - VIS POUR FIXATION PANNES DE TOIT		10	5x120	
		SCREW FOR GABLE - SCHRAUBEN FÜR GIEBEL - VIS POUR FIXATION DES PIGNONS		16	5x120	
		SCREW FOR 1. WALL BEAM - SCHRAUBE FÜR 1. BOHLENREIHE - VIS DE FIXATIONS 1ERE RANGÉE DE MADRIERS AVEC POUTRELLES DE FONDATIONS		12	5x90	
		SCREW FOR FOUNDATION - SCHRAUBEN ZUR BEFESTIGUNG FUNDAMENT - VIS DE FIXATIONS DES POUTRELLES DE FONDATIONS		56	5x90	
HS41		SCREW FOR DOOR JAMB - SCHRAUBE FÜR TÜRRAHMEN - VIS DE FIXATION PARTIE HAUTE AVEC MONTANTS DU CADRE DE PORTE		4	5x90	
HS105		SCREW FOR POS. 005/006 - SCHRAUBEN FÜR POS. 005/006 - VIS POUR POS. 005/006		4	6x180	
HS72		SCREW FOR SLIDING WALL TIE - SCHIEBEREGLER FÜR WAND - SABOT MÉTALLIQUE POUR FIXATION MUR		2	6x40	
		SCREW FOR POST HEIGHT ADJUSTMENT - SCHRAUBEN FÜR REGULIERUNGSSCHRAUBE FÜR PFOSTEN - VIS DE FIXATION DE SUPPORT RÉGLABLE DE POTEAU		8	6x50	
HS59		SCREW FOR DOORSTEP - SCHRAUBEN FÜR SWELLE - VIS POUR FIXATION BARRE DE SEUIL		3	4.5x65	
		ZN NAIL FOR FLOOR FILLET - ZN NÄGEL FÜR FUSSBODENLEISTE - POINTE POUR CORNIERE DE FINITION DU PLANCHER		42	1.4x40	
SH44		HAMMER BLOCK - SCHLAGHOLZ - CALLE DE FRAPPE		1		
		DRIVE NUT TREADED ROD - EINSHLAGMUTTER FÜR GEWINDESTANGE - ÉCROU A FRAPPER POUR TIGE FILITÉE		4	D10	

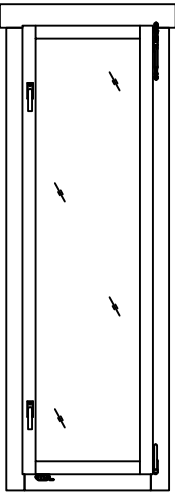
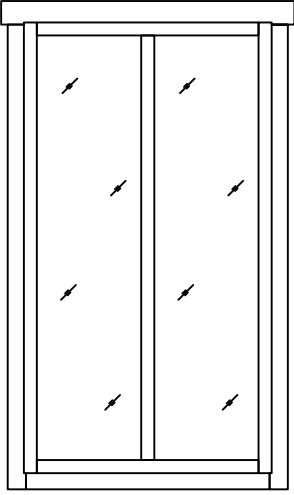
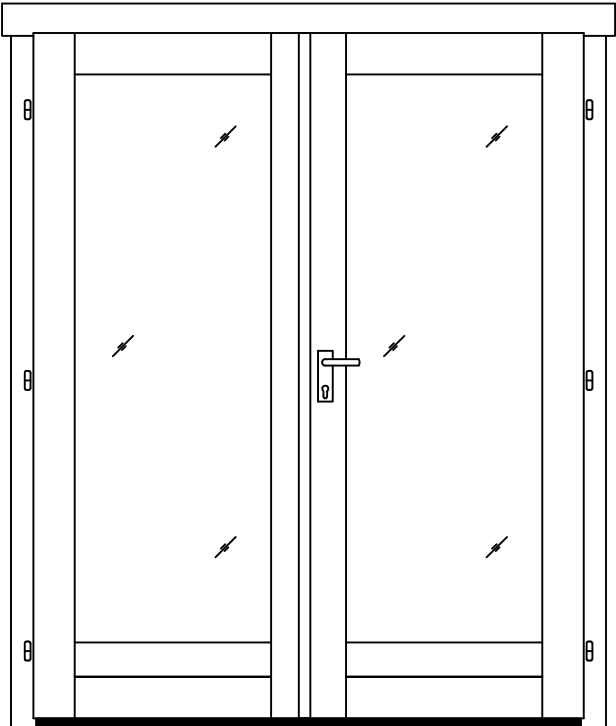
Pos	12.01.2015 Piece list - Stückliste - Liste des pièces Art.Nr. 4420302	11/11	Q	P (mm)	L (mm)
	WINDOW - FENSTER - FENETRE 560x1780 	AK.1.100.PSP DGP	1		
	WINDOW - FENSTER - FENETRE 1010x1780 	TAK.1.100.PM0.e DGP	1		
	DOOR - TÜR - PORTE 1588x1957 	TUK.1.100.PVP.MM DGP	1		