

*Jette ISO*  
*Art. Nr. 4011702*  
*1/8*

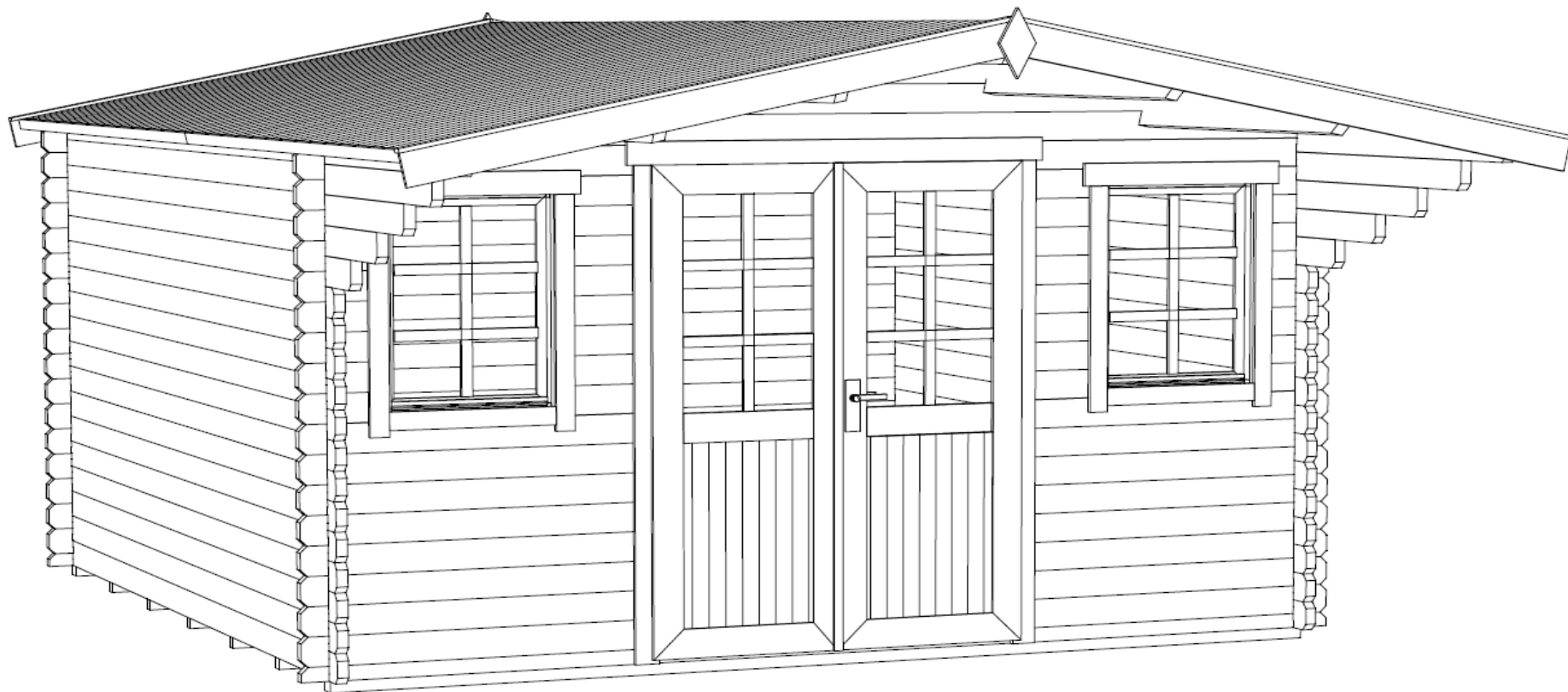

GROUNDPLAN - GRUNDPLAN - PLAN DE MASSE

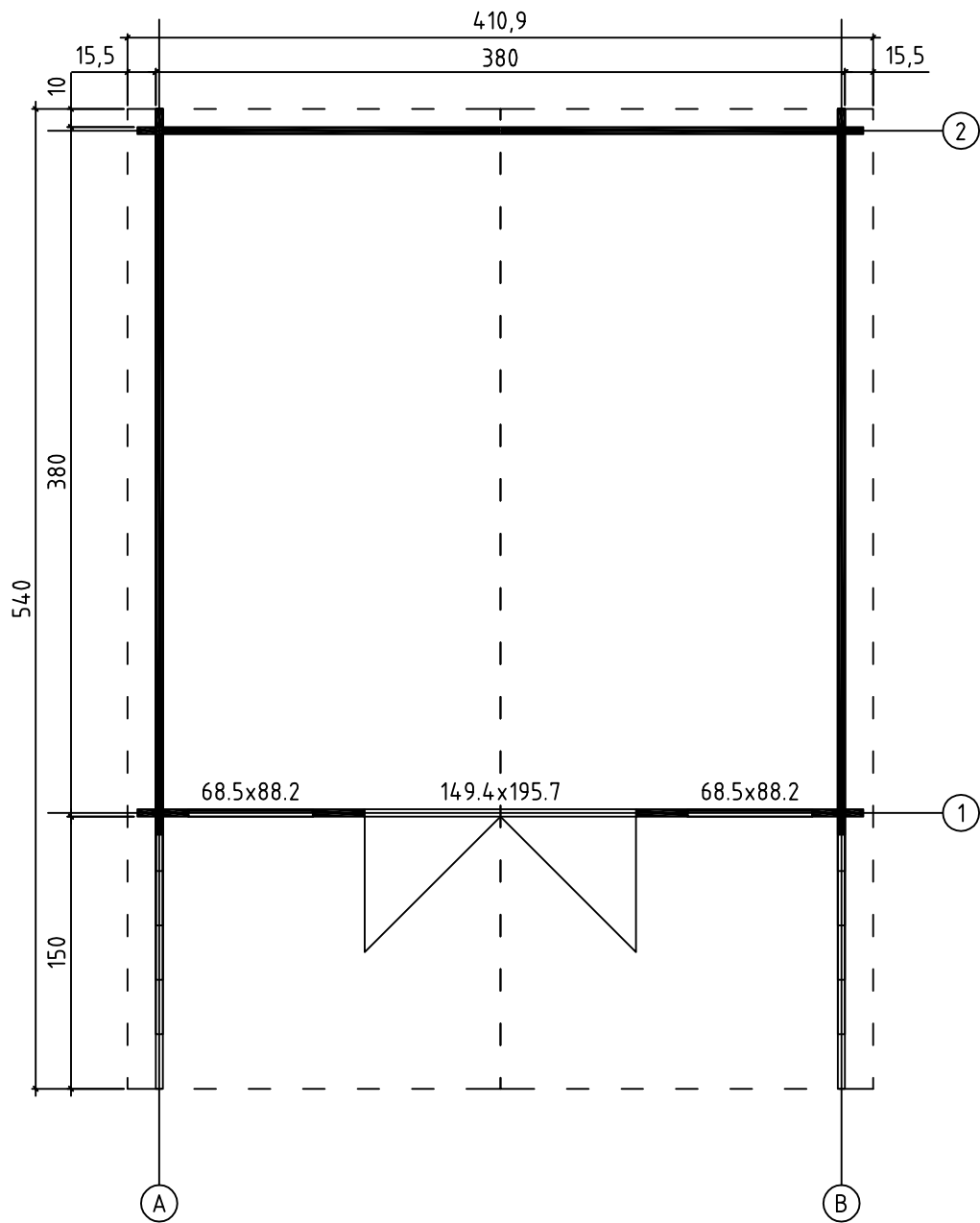

FOUNDATION - FUNDAMENT - FONDATION

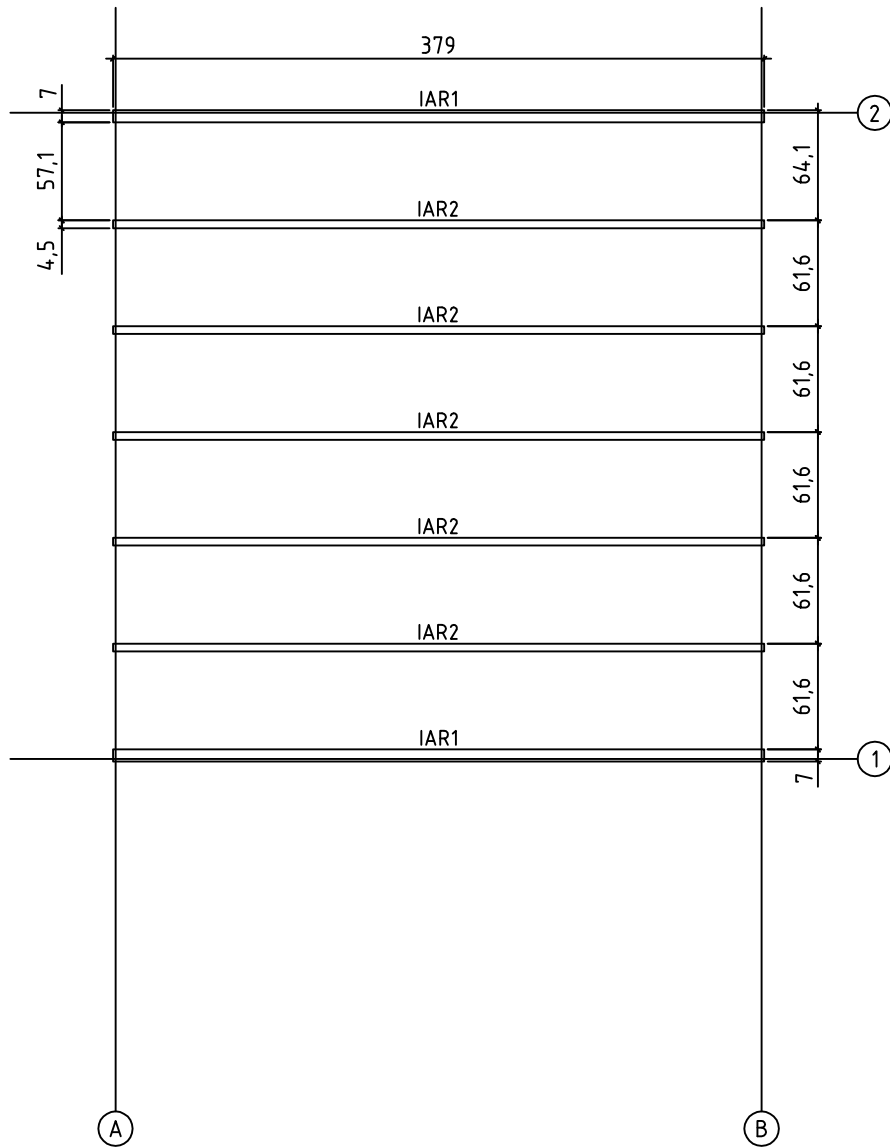



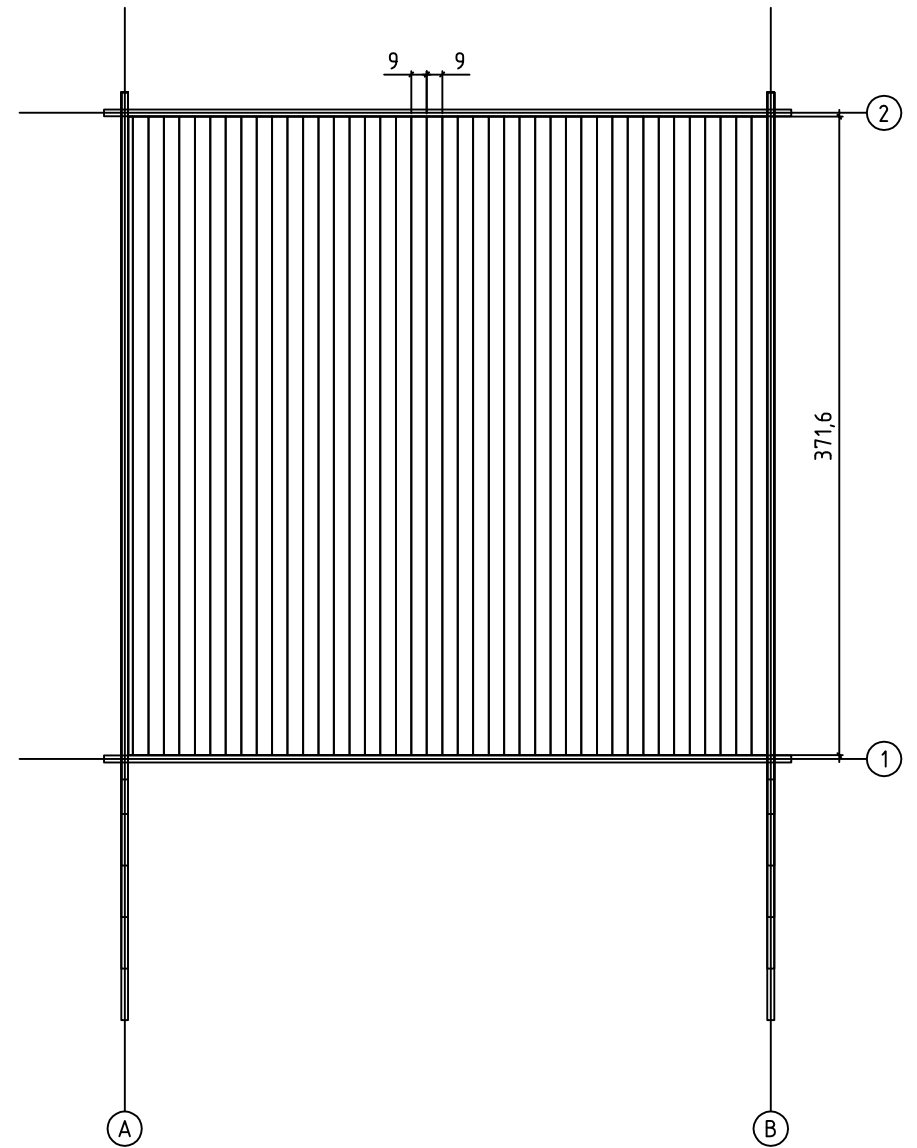

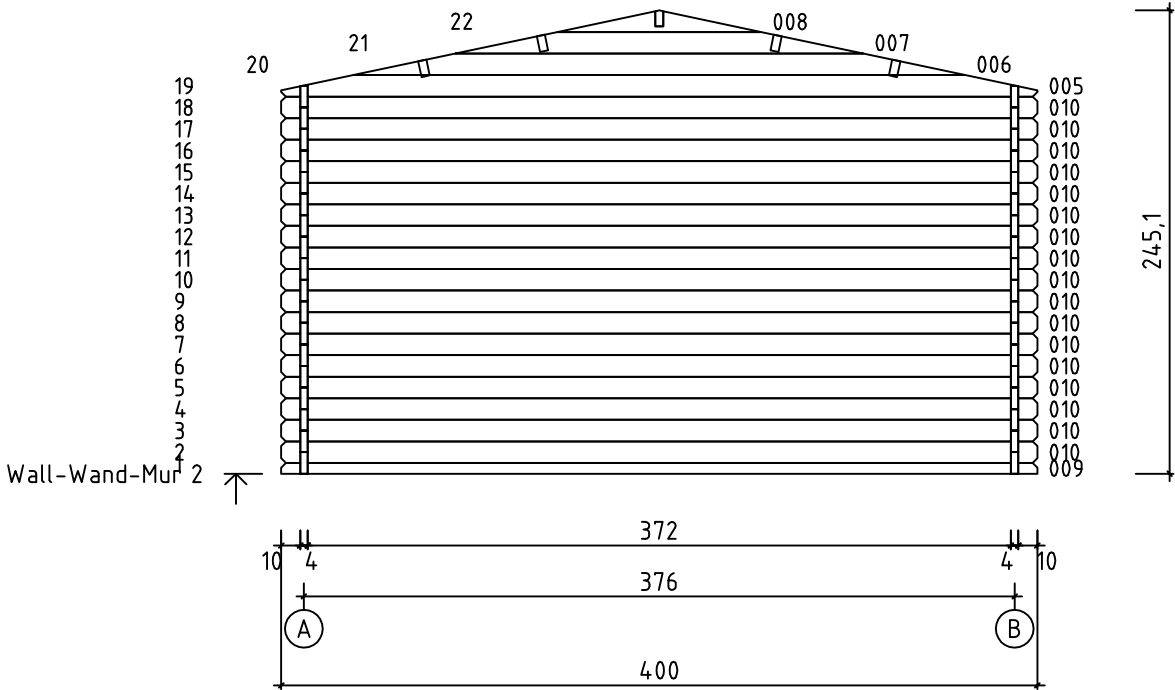
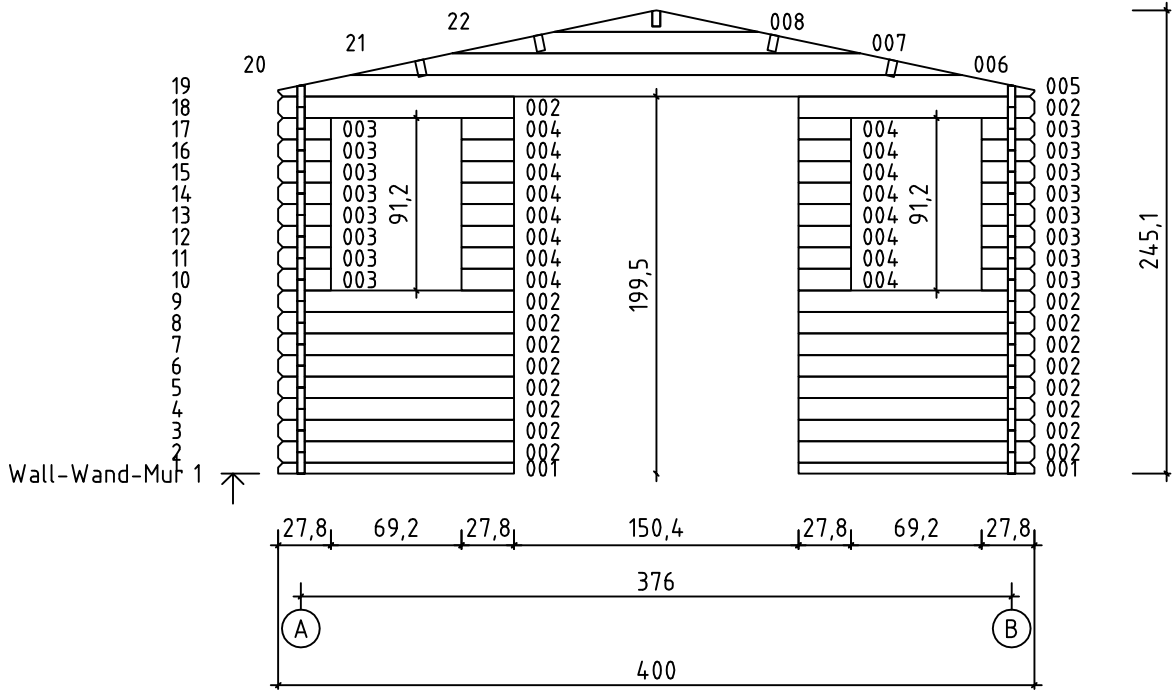

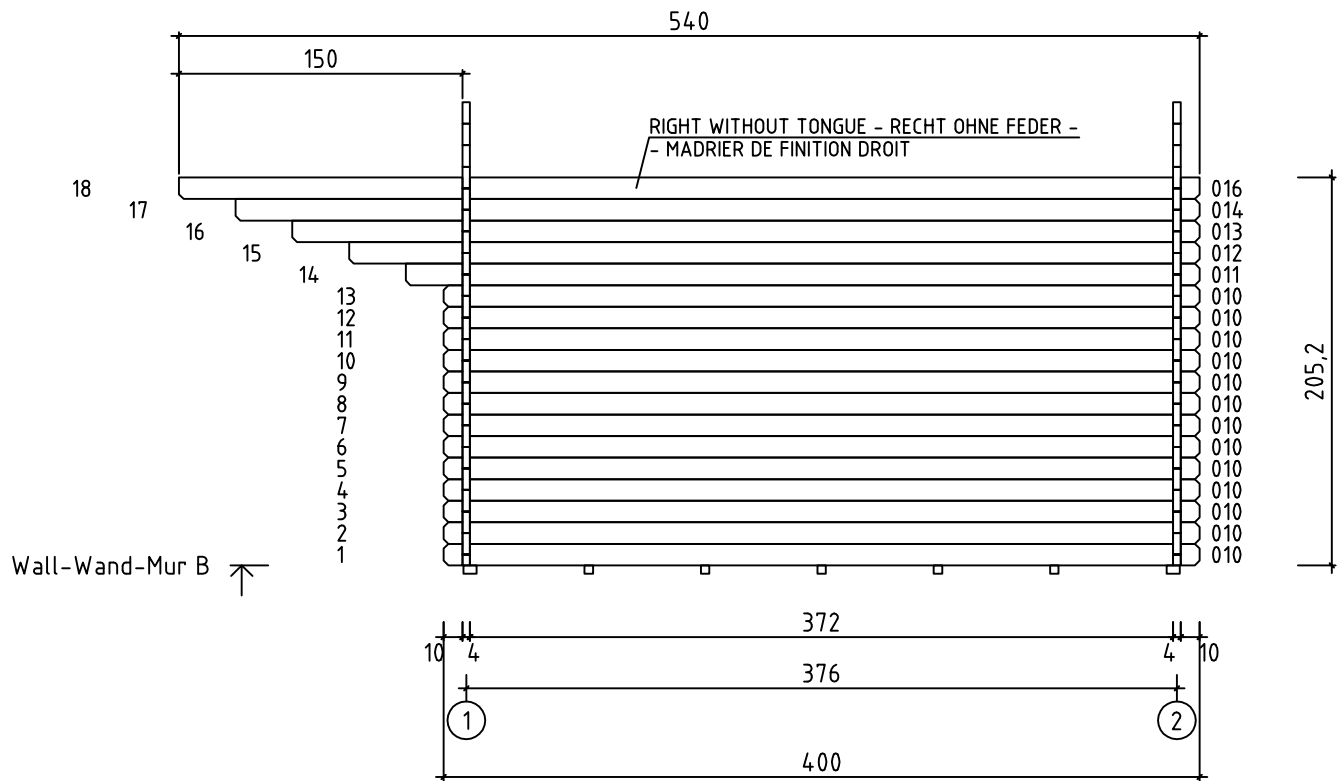
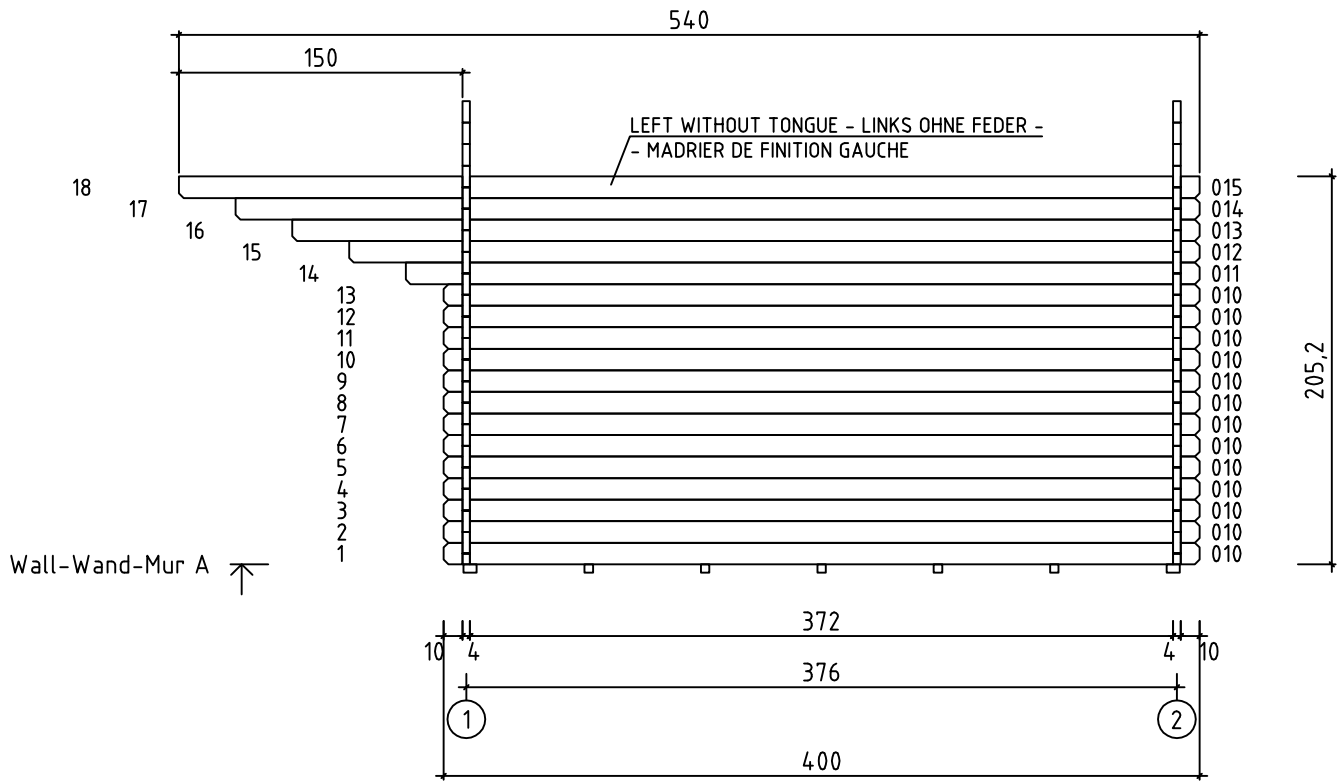



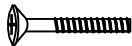

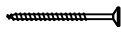
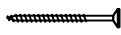

FLOOR BOARDS - FUSSBODENBRETTER - LAME DE PLANCHER



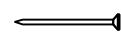
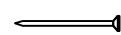

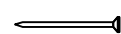
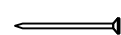
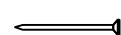
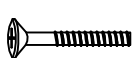

Pos	21.12.2015	Piecelist - Stücklist - Liste des composants Art. Nr. 4011702	6/8	Q.	P. (mm)	L. (mm)
001				2	40x57	1248
002				18	40x114	1248
003				16	40x114	278
004				16	40x114	278
009				1	40x57	4000
010				43	40x114	4000
011				2	40x114	4200
012				2	40x114	4500
013				2	40x114	4800
014				2	40x114	5100
015				1	40x120	5400
016				1	40x120	5400
W1-1 W2-1				1 1		
IAR1	FOUNDATION - FUNDAMENT - FONDATION 			2	70x45	3790
IAR2	FOUNDATION - FUNDAMENT - FONDATION 			5	45x45	3790
PR1	ROOF BEAM - DACHBALKEN - PANNE DE TOIT 			1	44x140	5400
A-PR1	ROOF BEAM - DACHBALKEN - PANNE DE TOIT 			4	44x140	5400
	FLOOR BOARDS - FUSSBODENBRETTER - LAME DE PLANCHER 			42	90x18	3716
	ROOF BOARDS - DACHBRETTER - VOLIGES 			120	90x15	2100
	FLOOR FILLET - FUSSBODENLEISTE - CORNIERE DE FINITION DU PLANCHER 				18x18	14.86
DPL-1	ROOFING FELT FILLET - DACHPAPPENLEISTE - BAGUETTE DE FIXATION DU FEUTRE BITUMEUX 			4	15x45	2150
TB-1	FASCIA BOARD - TRAUFBRETT - BANDEAU DE TOIT 			4	15x45	2700
KFS-1	STORM PROTECTION - STURMLEISTE - - LATTE ANTI-TEMPETE 			4	22x45	1980
GL-1	GABLE MOULDING - GIEBELLEISTE - - PLANCHE DE RIVE 			4	15x120	2150

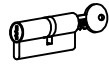
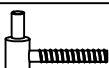
Pos	21.12.2015	Piecelist - Stücklist - Liste des composants Art. Nr. 4011702	7/8	Q.	P. (mm)	L. (mm)
FS		WINDOW HANDLE FITTINGS - FENSTERGRIFF - POIGNEE DE FENETRE		2		
		BOLT FOR WINDOW HANDLE FITTINGS - BOLZEN FÜR FENSTERGRIFF BESCHLAG - VIS POUR FIXATION POIGNEE DE FENETRE		4		
HS12		SCREW FOR GABLE SEGMENT - SCHRAUBEN FÜR DECKBLATT - VIS POUR FIXATION LOSANGE DE FINITION		4	3.5x35	
HS16		SCREW FOR GABLE MOULDING - SCHRAUBEN FÜR GIEBELLEISTE - VIS POUR FIXATION PLANCHE DE RIVE		32	3.5x50	
HS3		SCREW FOR DOOR FILLET - SCHRAUBE ZUR BEFESTIGUNG TÜRLEISTE - VIS POUR FIXATION BAGUETTE D'ARRET DE PORTE		5	3x30	
HS32		SCREW FOR FASCIA BOARDS - SCHRAUBEN FÜR TRAUFBRETTTER - VIS POUR FIXATION BANDEAU DE TOIT		24	4x40	
HS43		SCREW FOR ROOF BEAMS - SCHRAUBEN FÜR DACHBALKEN - VIS POUR FIXATION PANNES DE TOIT		14	5x120	
		SCREW FOR 1. WALL BEAM - SCHRAUBE FÜR 1. BOHLENREIHE - VIS DE FIXATIONS 1ÈRE RANGÉE DE MADRIERS AVEC POUTRELLES DE FONDATIONS		7	5x90	
HS41		SCREW FOR DOOR JAMB - SCHRAUBE FÜR TÜRRAHMEN - VIS DE FIXATION PARTIE HAUTE AVEC MONTANTS DU CADRE DE PORTE		4	5x90	
HS59		SCREW FOR DOORSTEP - SCHRAUBEN FÜR SWELLE - VIS POUR FIXATION BARRE DE SEUIL		3	4.5x65	
		WINDOW/DOOR CROSS SLOT STRAIGHT (PLASTIC) - FENSTER/TÜREN EINSENWAREN - QUINCAILLERIE POUR PORTES ET FENETRES		24		
		NAIL FOR WINDOW/DOOR CROSS SLOT STRAIGHT - NÄGEL FÜR FENSTER/TÜREN EINSENWAREN - POINTE POUR QUINCAILLERIE POUR PORTES ET FENETRES		48	1.4x30	
		ZN NAIL FOR FLOOR FILLET - ZN NÄGEL FÜR FUSSBODENLEISTE - POINTE POUR CORNIERE DE FINITION DU PLANCHER		30	1.4x40	
SH40		HAMMER BLOCK - SCHLAGHOLZ - CALLE DE FRAPPE		1		
SFS		NUT FOR STORM PROTECTION - SCHRAUBENMUTTER FÜR STURMLEISTE - ECROU POUR LATTE ANTI-TEMPETE		8	D6	
NF2		ZN NAIL FOR ROOF - ZN NÄGEL FÜR DACHBRETTTER - POINTE POUR FIXATION VOLIGES DE TOIT		500	2x50	
		ZN NAIL FOR FLOOR - ZN NÄGEL FÜR FUSSBODENBRETTTER - CLOUS POUR PLANCHER		301	2x50	
NFD		ZN NAIL FOR ROOFING FELT FILLET - ZN NÄGEL FÜR DACHPAPPENLEISTE - POINTE POUR BAGUETTE DE FIXATION FEUTRE BITUMEUX		20	2x40	
BFS		BOLT FOR STORM PROTECTION - BOLZEN FÜR STURMLEISTE - BOULON POUR LATTE ANTI-TEMPETE		8	6x70	
GS		GABLE SEGMENT - DECKBLATT - LOSANGE DE FINITION		2		
DFS		WASHER FOR STORM PROTECTION - DICHTSCHEIBE FÜR STURMLEISTE - RONDELLE POUR LATTE ANTI-TEMPETE		8	D6	
TL4		DOOR HANDLE FITTINGS - TÜRGRIFF - POIGNEE DE PORTE		1		
TL5		SET OF DOOR LOCK COVERS - SCHLOSSBLENDEN - SET DE GARNITURES DE PORTE		1		
		CYLINDER LOCK - ZYLINDERSCHLOSS - BARILLET DE PORTE		1	30/35	
		MALE BOLT HINGE FOR DOOR - TÜRRIEGEL - PARTIE MALE DE PAUMELLE DE PORTE		6	16/52	

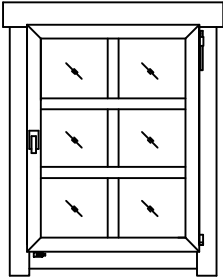
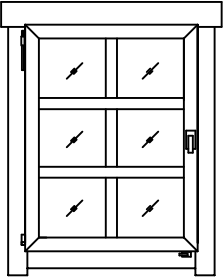
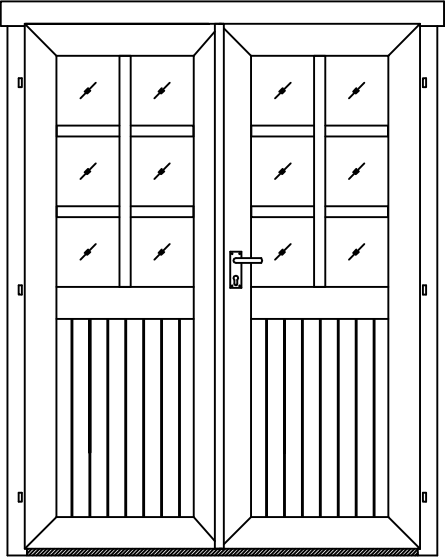
Pos	21.12.2015 Piecelist - Stücklist - Liste des composants Art. Nr. 4011702	8/8	Q.	P. (mm)	L. (mm)
	WINDOW - FENSTER - FENETRE 685x882 DGC+E 	AK.1.106.PSP.Pd	1		
	WINDOW - FENSTER - FENETRE 685x882 DGC+E 	AK.1.106.PSV.Pd	1		
	DOOR - TÜR - PORTE 1494x1957 DGC+E 	TUK.2.056.PVP.MMPb	1		



A=A

B=B

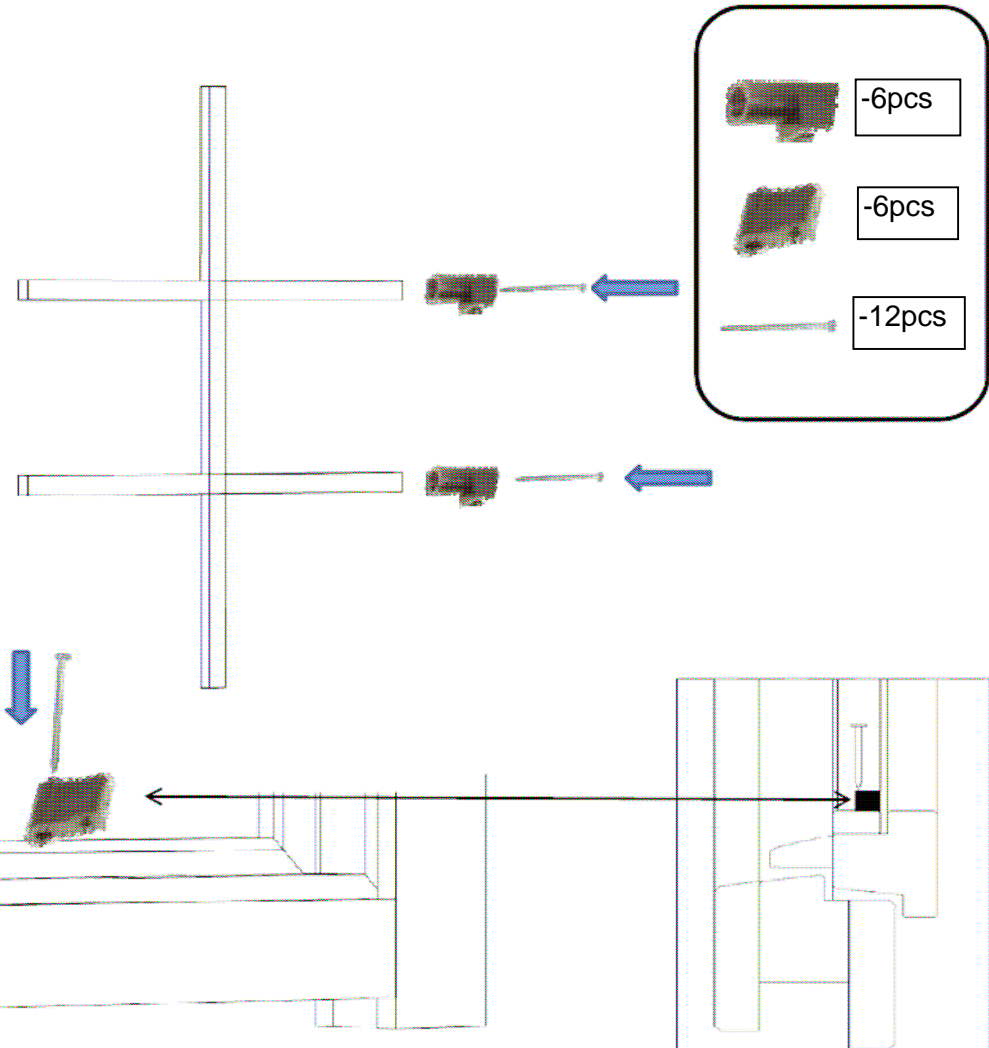
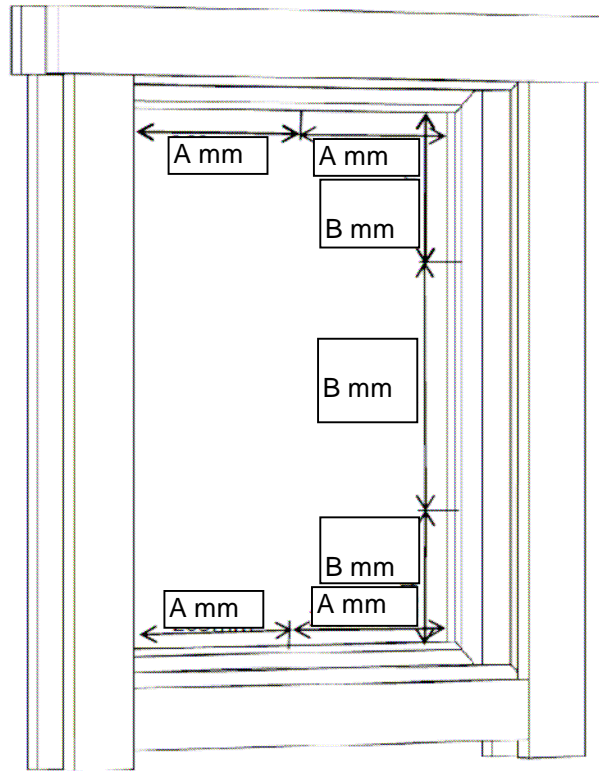

A=A

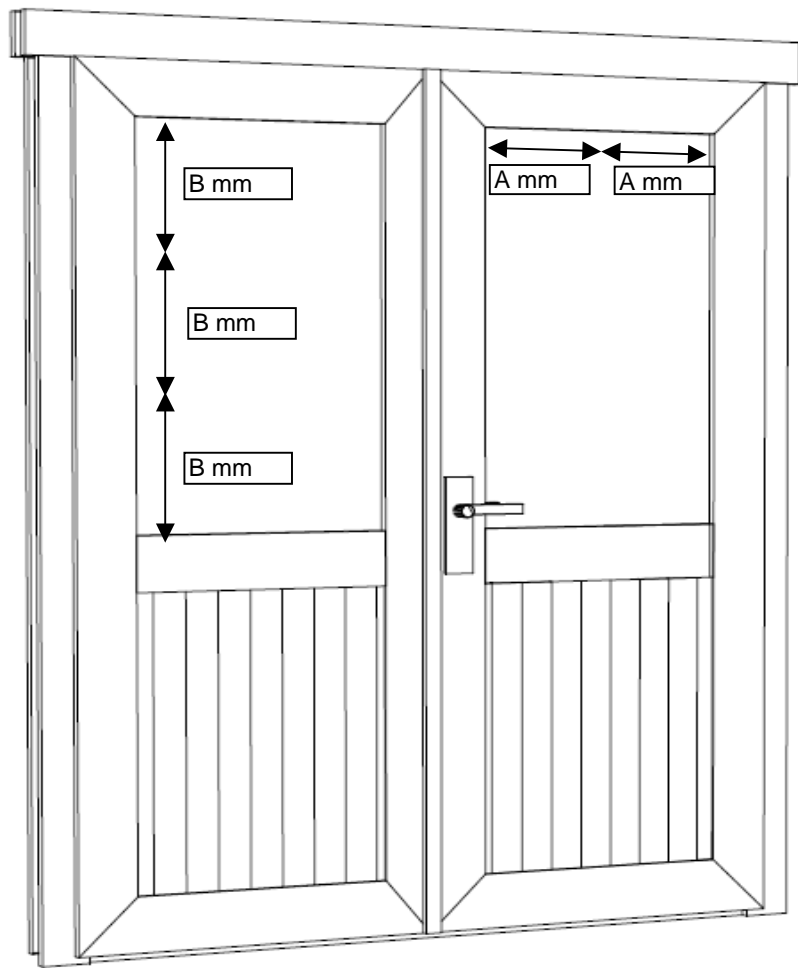

B=B

