

*Jule ISO*  
*Art. Nr. 4011802*  
*1/8*

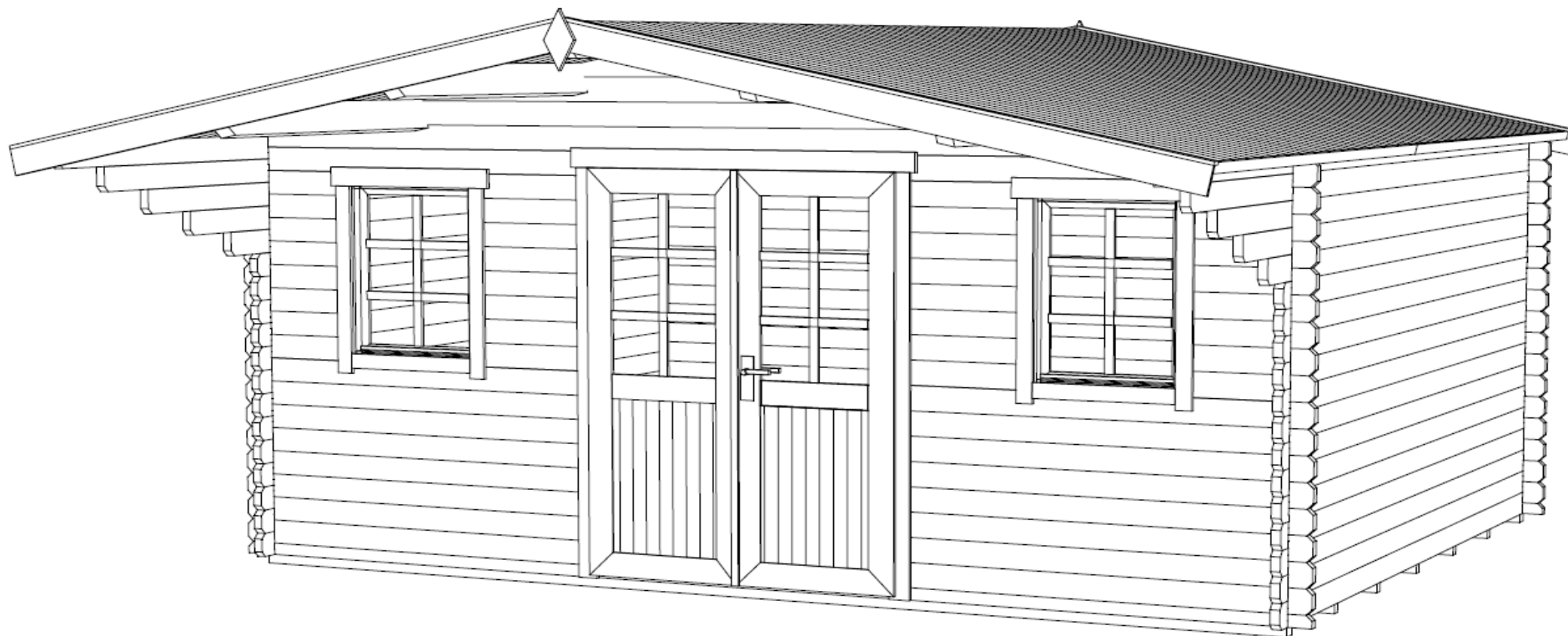

GROUNDPLAN - GRUNDPLAN - PLAN DE MASSE

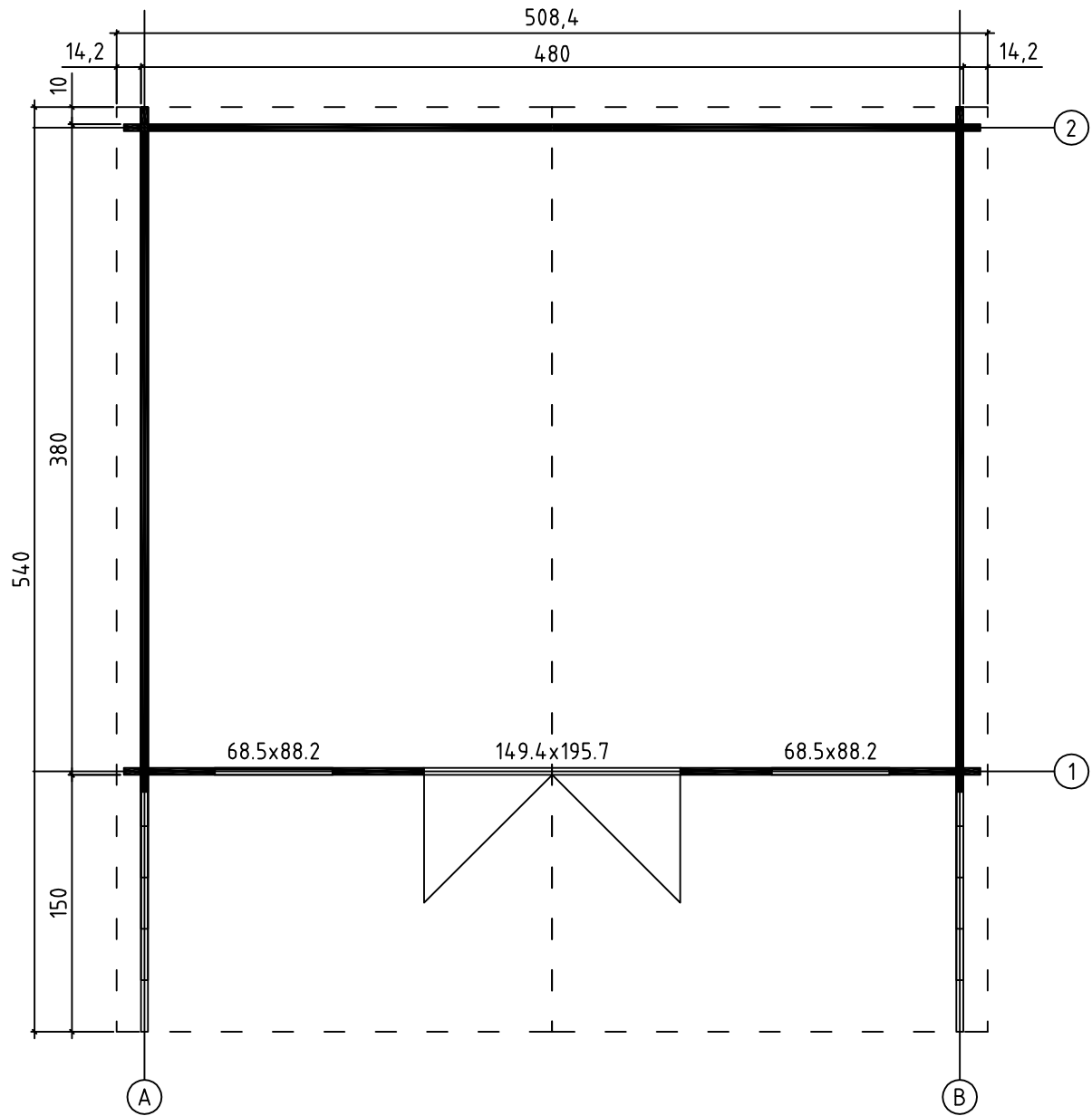

FOUNDATION - FUNDAMENT - FONDATION

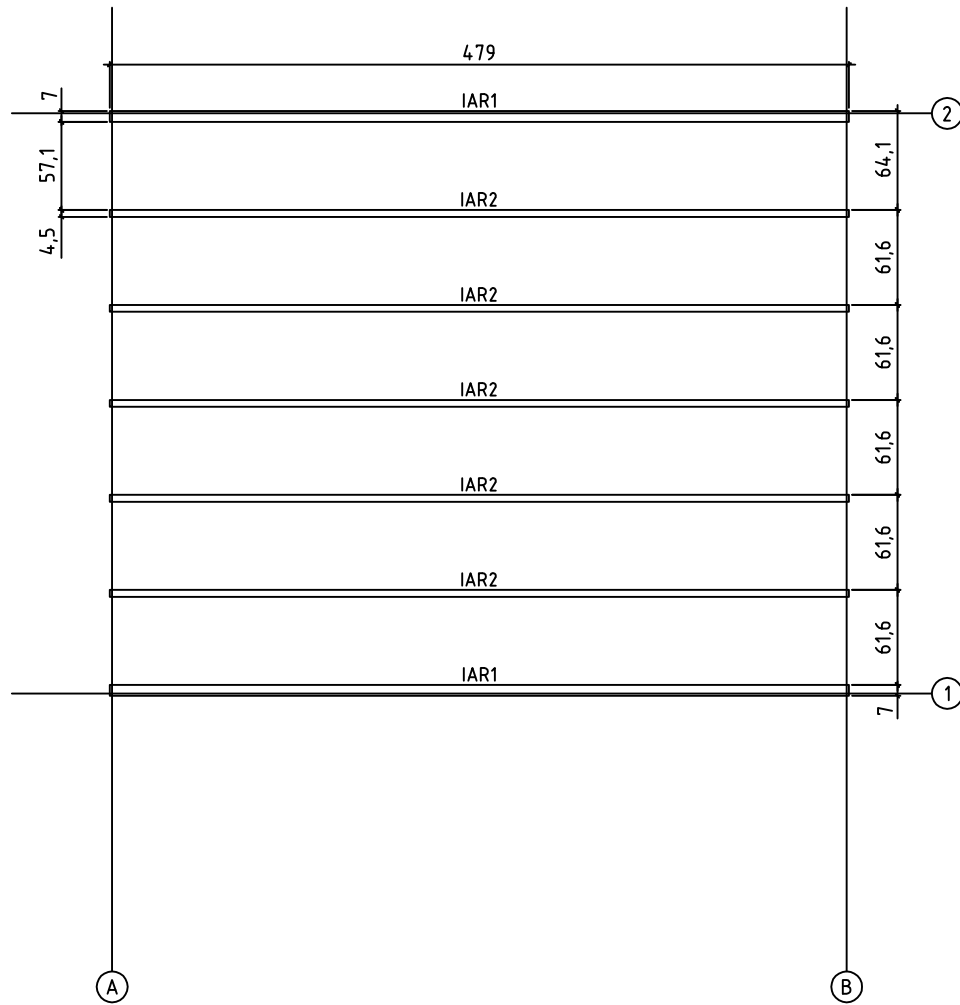



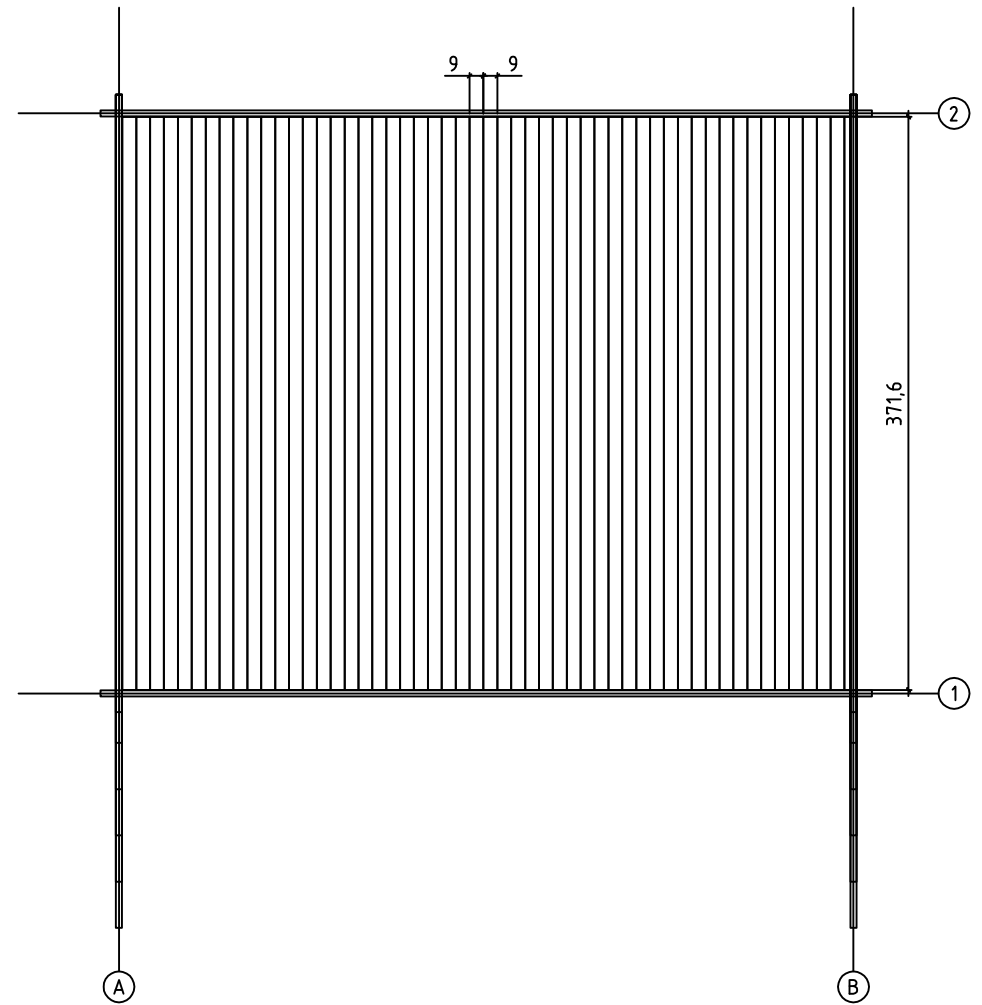



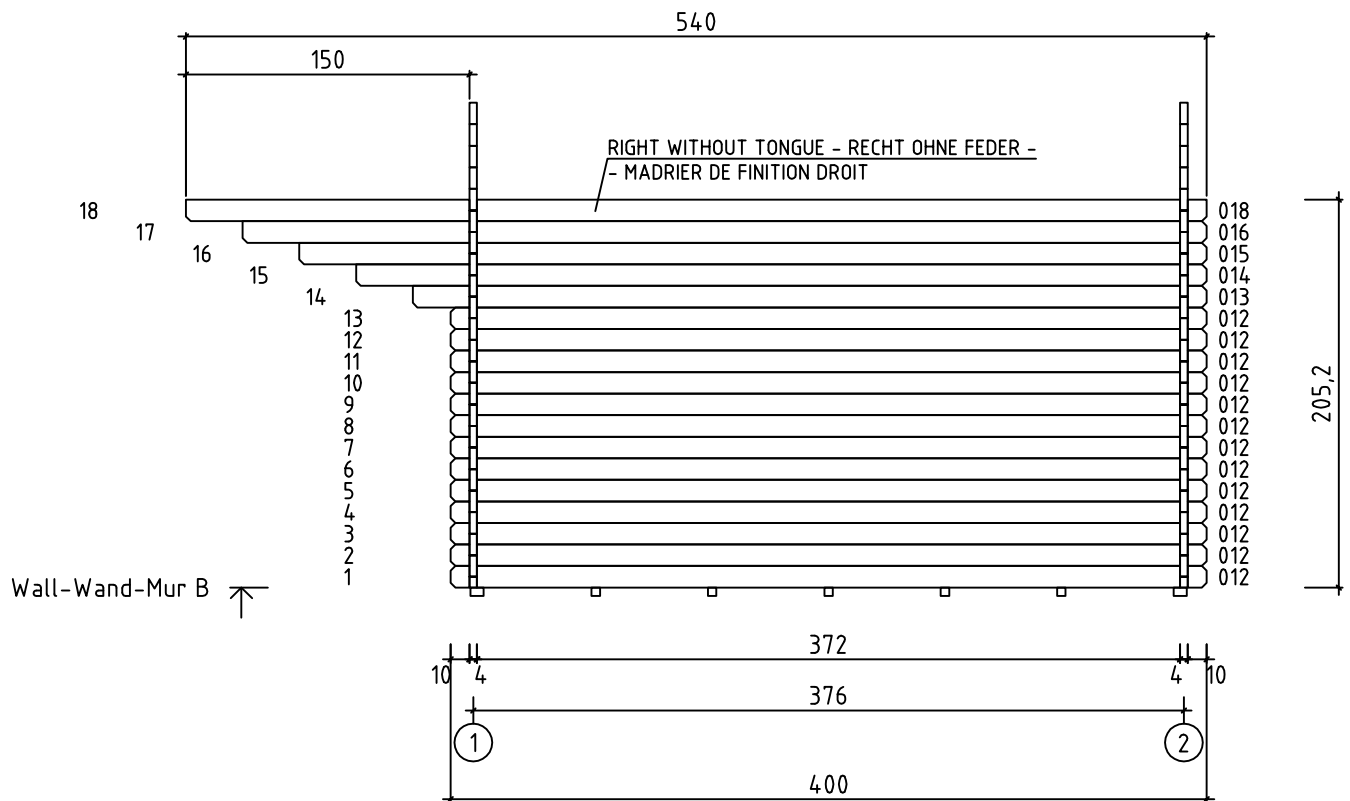
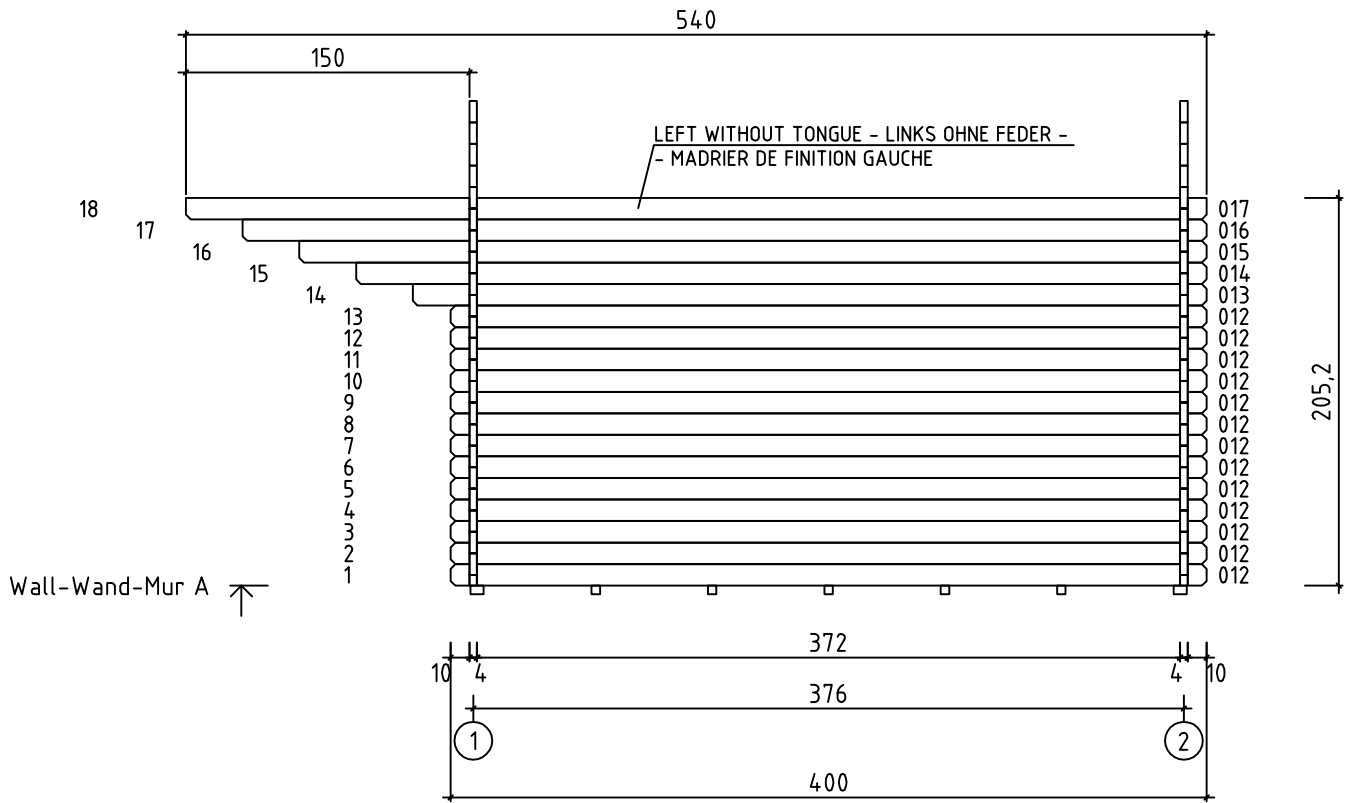

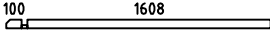
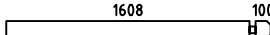

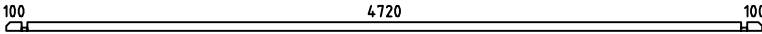
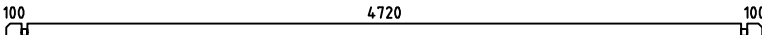
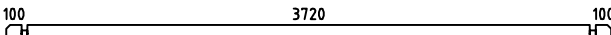
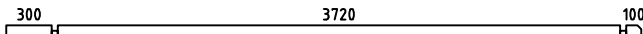
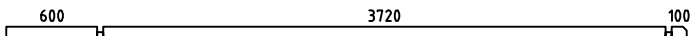
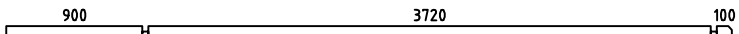
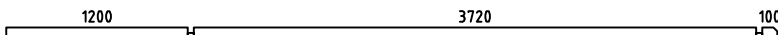

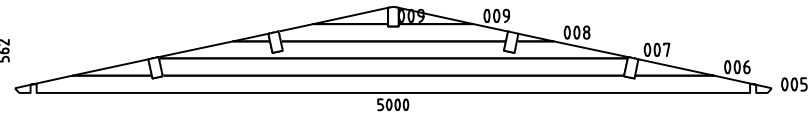





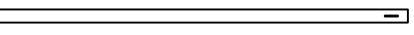

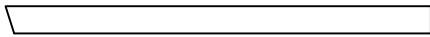

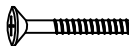
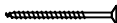
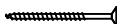
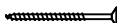
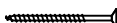





FLOOR BOARDS - FUSSBODENBRETTER - LAME DE PLANCHER



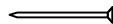

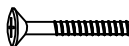

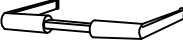
Pos	11.01.2016	Piecelist - Stücklist - Liste des composants Art. Nr. 4011802	6/8	Q.	P. (mm)	L. (mm)
001				2	40x57	1748
002				18	40x114	1748
003				16	40x114	528
004				16	40x114	528
010				1	40x57	5000
011				17	40x114	5000
012				26	40x114	4000
013				2	40x114	4200
014				2	40x114	4500
015				2	40x114	4800
016				2	40x114	5100
017				1	40x120	5400
018				1	40x120	5400
W1-1 W2-1				1 1		
IAR1	FOUNDATION - FUNDAMENT - FONDATION			2	70x45	4790
IAR2	FOUNDATION - FUNDAMENT - FONDATION			5	45x45	4790
PR1	ROOF BEAM - DACHBALKEN - PANNE DE TOIT			1	70x140	5400
A-PR1	ROOF BEAM - DACHBALKEN - PANNE DE TOIT			4	70x140	5400
	FLOOR BOARDS - FUSSBODENBRETT - LAME DE PLANCHER			53	90x18	3716
	ROOF BOARDS - DACHBRETT - VOLIGES			120	90x15	2600
	FLOOR FILLET - FUSSBODENLEISTE - CORNIERE DE FINITION DU PLANCHER				18x18	16.86
DPL-1	ROOFING FELT FILLET - DACHPAPPENLEISTE - BAGUETTE DE FIXATION DU FEUTRE BITUMEUX			4	15x45	2650
TB-1	FASCIA BOARD - TRAUFBRETT - BANDEAU DE TOIT			4	15x45	2700
KFS-1	STORM PROTECTION - STURMLEISTE - - LATTE ANTI-TEMPETE			4	22x45	1900

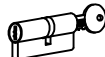
Pos	11.01.2016	Piecelist - Stücklist - Liste des composants Art. Nr. 4011802	7/8	Q.	P. (mm)	L. (mm)
GL-1	GABLE MOULDING - GIEBELLEISTE - - PLANCHE DE RIVE			4	15x120	2650
FS	WINDOW HANDLE FITTINGS - FENSTERGRIFF - POIGNEE DE FENETRE			2		
	BOLT FOR WINDOW HANDLE FITTINGS - BOLZEN FÜR FENSTERGRIFF BESCHLAG - VIS POUR FIXATION POIGNEE DE FENETRE			4		
HS12	SCREW FOR GABLE SEGMENT - SCHRAUBEN FÜR DECKBLATT - VIS POUR FIXATION LOSANGE DE FINITION			4	3.5x35	
HS16	SCREW FOR GABLE MOULDING - SCHRAUBEN FÜR GIEBELLEISTE - VIS POUR FIXATION PLANCHE DE RIVE			32	3.5x50	
HS3	SCREW FOR DOOR FILLET - SCHRAUBE ZUR BEFESTIGUNG TÜRLEISTE - VIS POUR FIXATION BAGUETTE D'ARRET DE PORTE			5	3x30	
HS32	SCREW FOR FASCIA BOARDS - SCHRAUBEN FÜR TRAUFBRETT - VIS POUR FIXATION BANDEAU DE TOIT			20	4x40	
HS43	SCREW FOR ROOF BEAMS - SCHRAUBEN FÜR DACHBALKEN - VIS POUR FIXATION PANNES DE TOIT			14	5x120	
	SCREW FOR 1. WALL BEAM - SCHRAUBE FÜR 1. BOHLENREIHE - VIS DE FIXATIONS 1ÈRE RANGÉE DE MADRIERS AVEC POUTRELLES DE FONDATIONS			8	5x90	
HS41	SCREW FOR DOOR JAMB - SCHRAUBE FÜR TÜRRAHMEN - VIS DE FIXATION PARTIE HAUTE AVEC MONTANTS DU CADRE DE PORTE			4	5x90	
HS59	SCREW FOR DOORSTEP - SCHRAUBEN FÜR SWELLE - VIS POUR FIXATION BARRE DE SEUIL			3	4.5x65	
	WINDOW/DOOR CROSS SLOT STRAIGHT (PLASTIC) - FENSTER/TÜREN EINSENWAREN - QUINCAILLERIE POUR PORTES ET FENETRES			24		
	NAIL FOR WINDOW/DOOR CROSS SLOT STRAIGHT - NÄGEL FÜR FENSTER/TÜREN EINSENWAREN - POINTE POUR QUINCAILLERIE POUR PORTES ET FENETRES			48	1.4x30	
	ZN NAIL FOR FLOOR FILLET - ZN NÄGEL FÜR FUSSBODENLEISTE - POINTE POUR CORNIERE DE FINITION DU PLANCHER			34	1.4x40	
SH40	HAMMER BLOCK - SCHLAGHOLZ - CALLE DE FRAPPE			1		
SFS	NUT FOR STORM PROTECTION - SCHRAUBENMUTTER FÜR STURMLEISTE - ECROU POUR LATTE ANTI-TEMPETE			8	D6	
NF2	ZN NAIL FOR ROOF - ZN NÄGEL FÜR DACHBRETT - POINTE POUR FIXATION VOLIGES DE TOIT			412	2x50	
	ZN NAIL FOR FLOOR - ZN NÄGEL FÜR FUSSBODENBRETT - CLOUS POUR PLANCHER			378	2x50	
NFD	ZN NAIL FOR ROOFING FELT FILLET - ZN NÄGEL FÜR DACHPAPPENLEISTE - POINTE POUR BAGUETTE DE FIXATION FEUTRE BITUMEUX			24	2x40	
BFS	BOLT FOR STORM PROTECTION - BOLZEN FÜR STURMLEISTE - BOULON POUR LATTE ANTI-TEMPETE			8	6x70	
GS	GABLE SEGMENT - DECKBLATT - LOSANGE DE FINITION			2		
DFS	WASHER FOR STORM PROTECTION - DICHTSCHEIBE FÜR STURMLEISTE - RONDELLE POUR LATTE ANTI-TEMPETE			8	D6	
TL4	DOOR HANDLE FITTINGS - TÜRGRIFF - POIGNEE DE PORTE			1		
TL5	SET OF DOOR LOCK COVERS - SCHLOSSBLENDEN - SET DE GARNITURES DE PORTE			1		
	CYLINDER LOCK - ZYLINDERSCHLOSS - BARILLET DE PORTE			1	30/35	

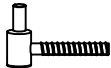
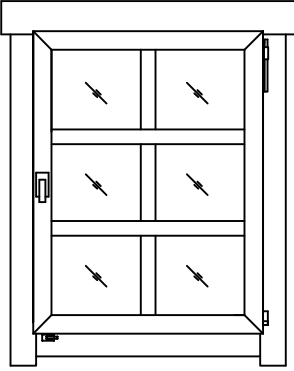
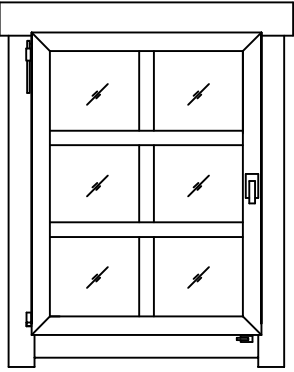
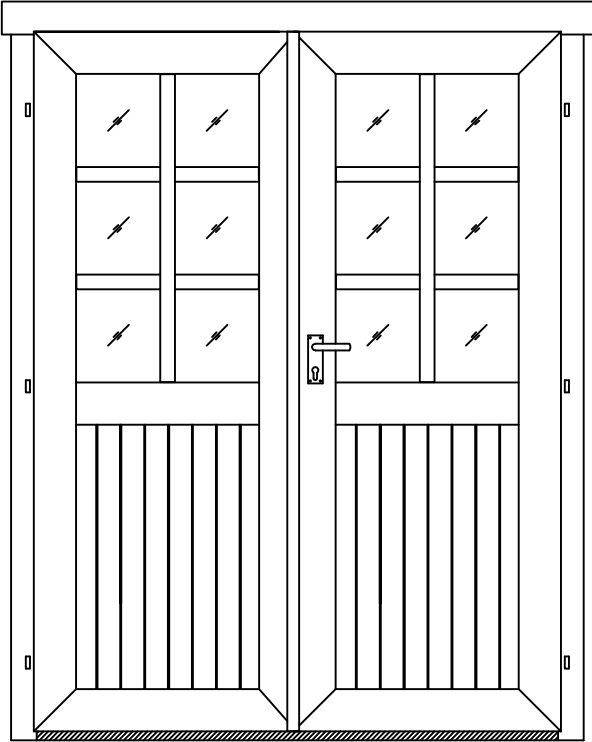
Pos	11.01.2016 Piecelist - Stücklist - Liste des composants Art. Nr. 4011802	8/8	Q.	P. (mm)	L. (mm)
	MALE BOLT HINGE FOR DOOR - TÜRRIEGEL - PARTIE MALE DE PAUMELLE DE PORTE		6	16/52	
	WINDOW - FENSTER - FENETRE 685x882 DGC+E 	AK.1.106.PSP.Pd	1		
	WINDOW - FENSTER - FENETRE 685x882 DGC+E 	AK.1.106.PSV.Pd	1		
	DOOR - TÜR - PORTE 1494x1957 DGC+E 	TUK.2.056.PVP.MMPb	1		



A=A

B=B

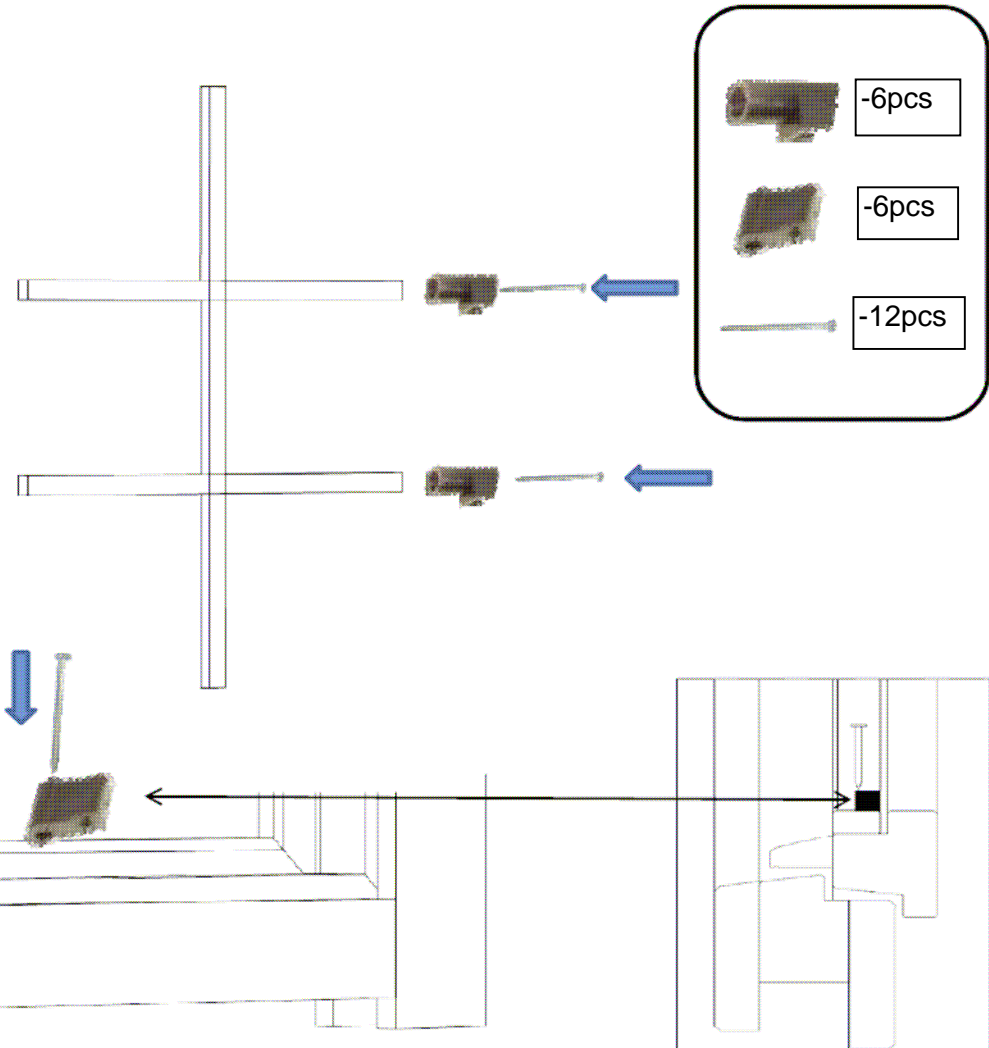
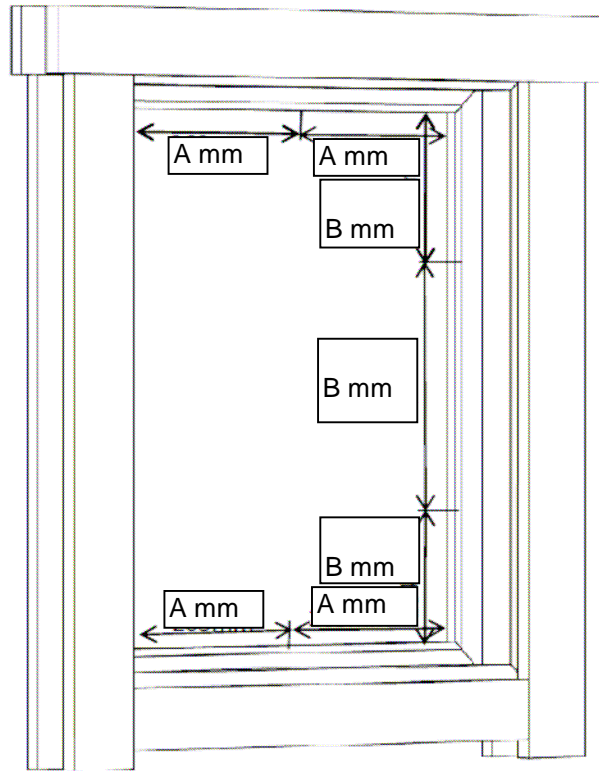

A=A

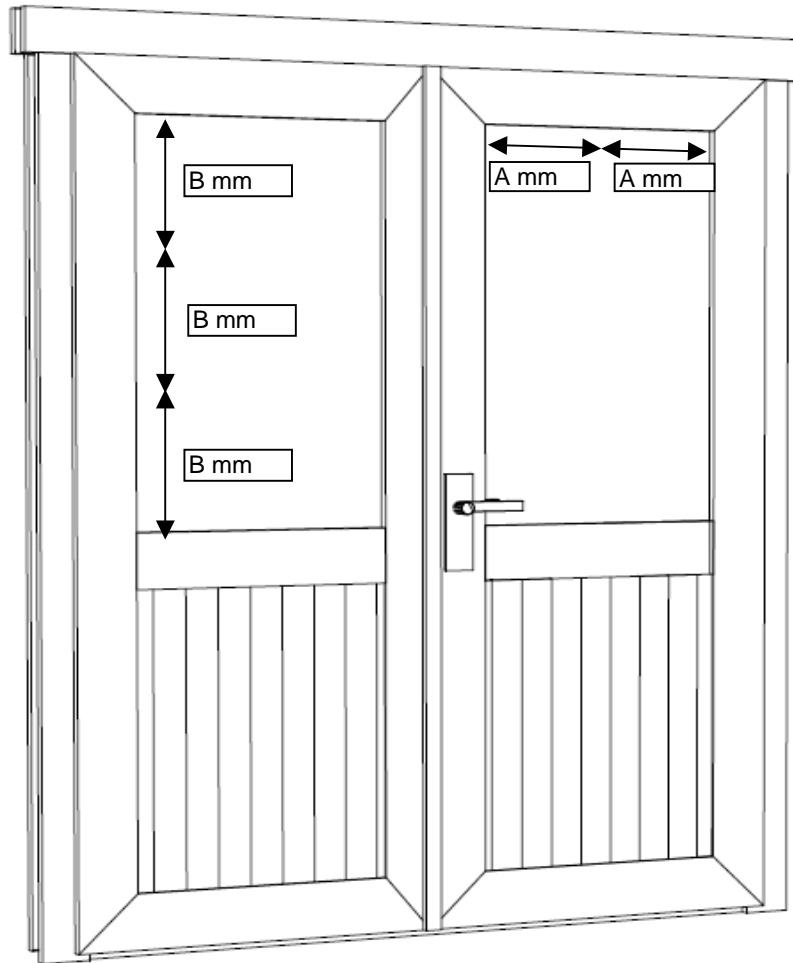

B=B

