

Linda
Art. Nr. 4012096

1/8

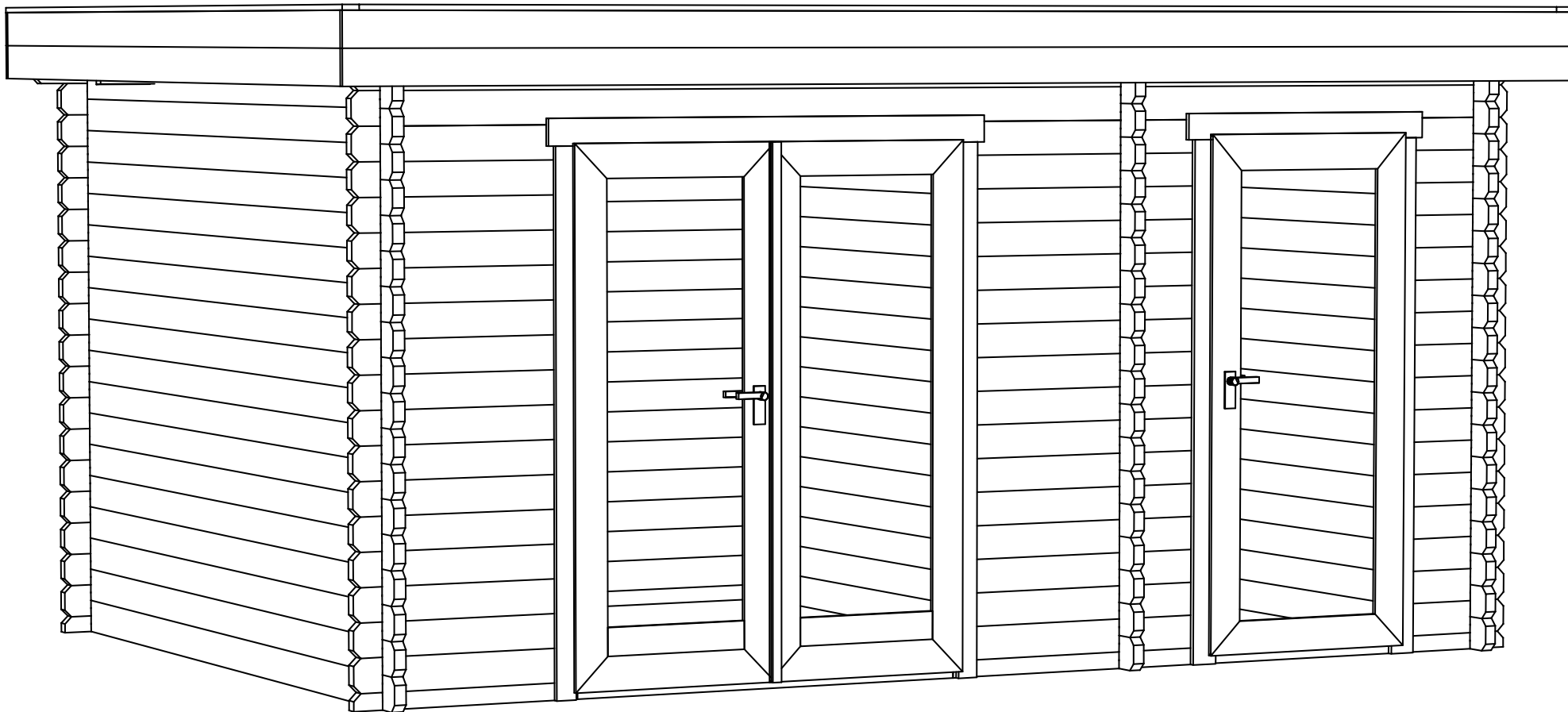

22.12.2015

GROUNDPLAN - GRUNDPLAN - PLAN DE MASSE

Art. Nr. 4012096

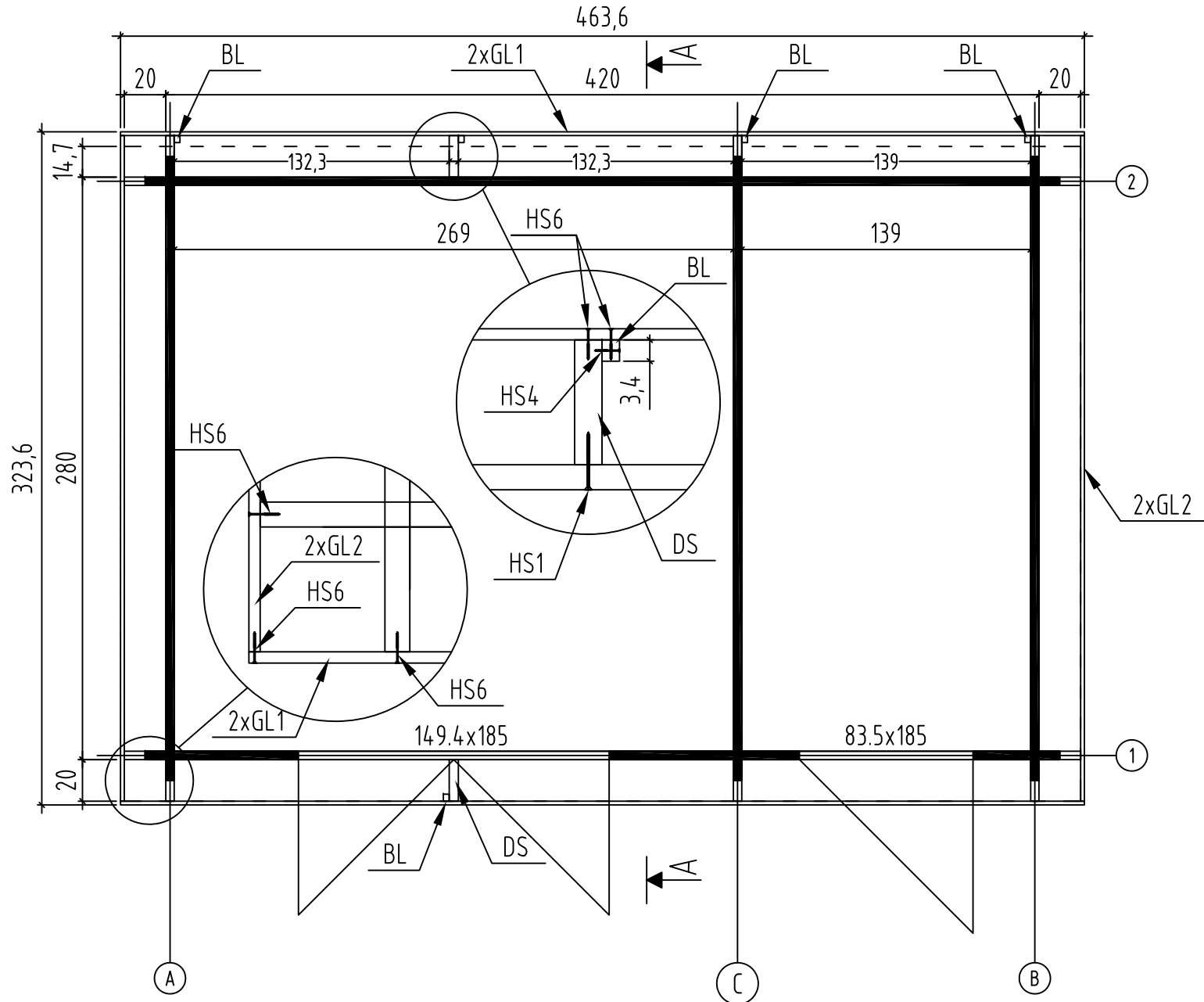

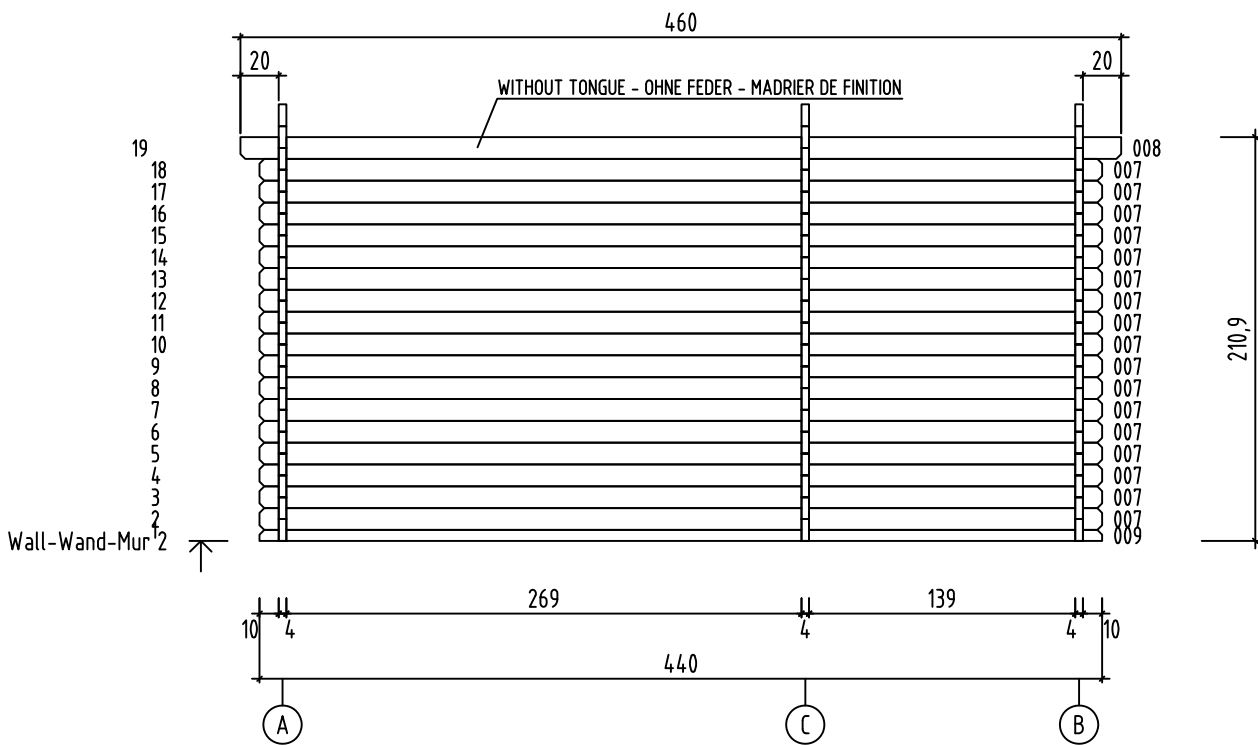
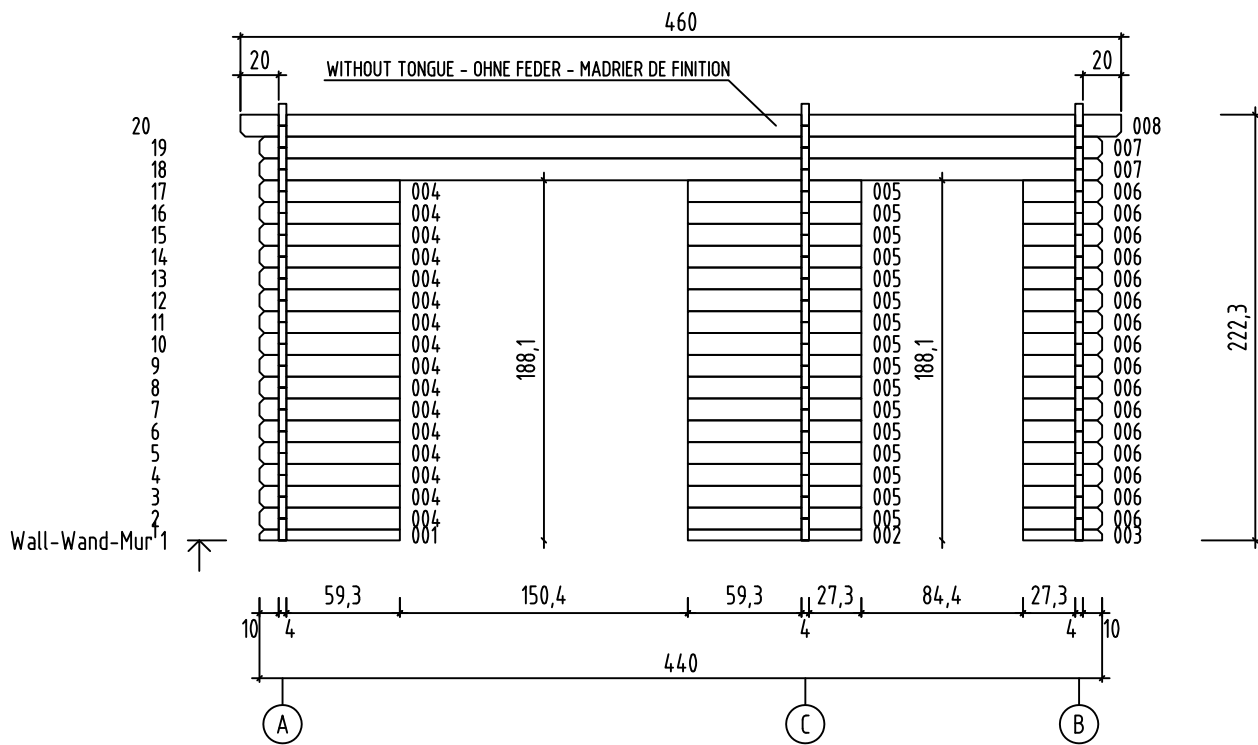

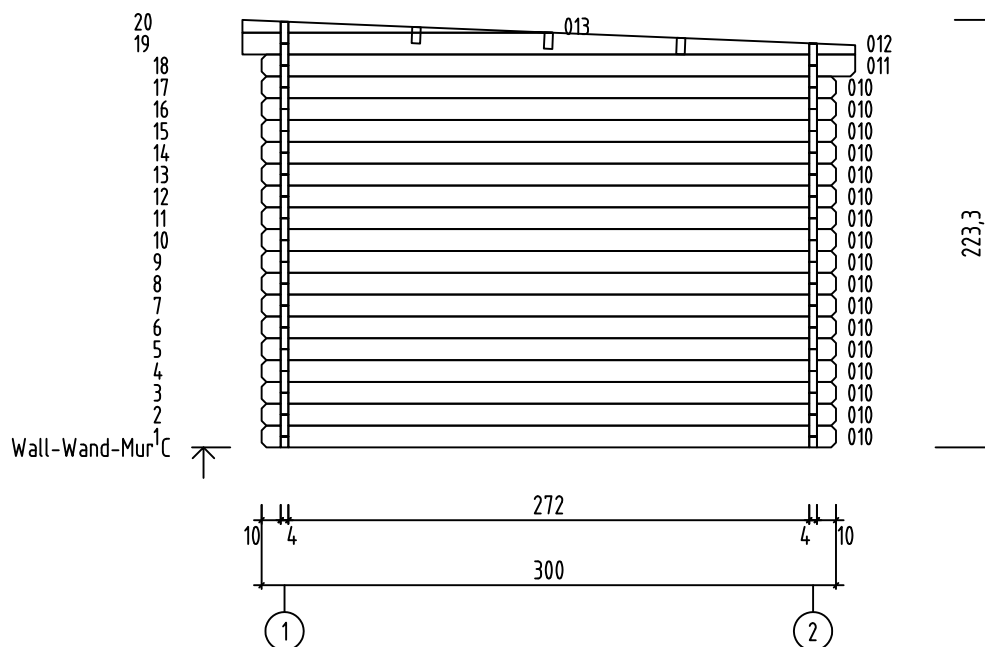
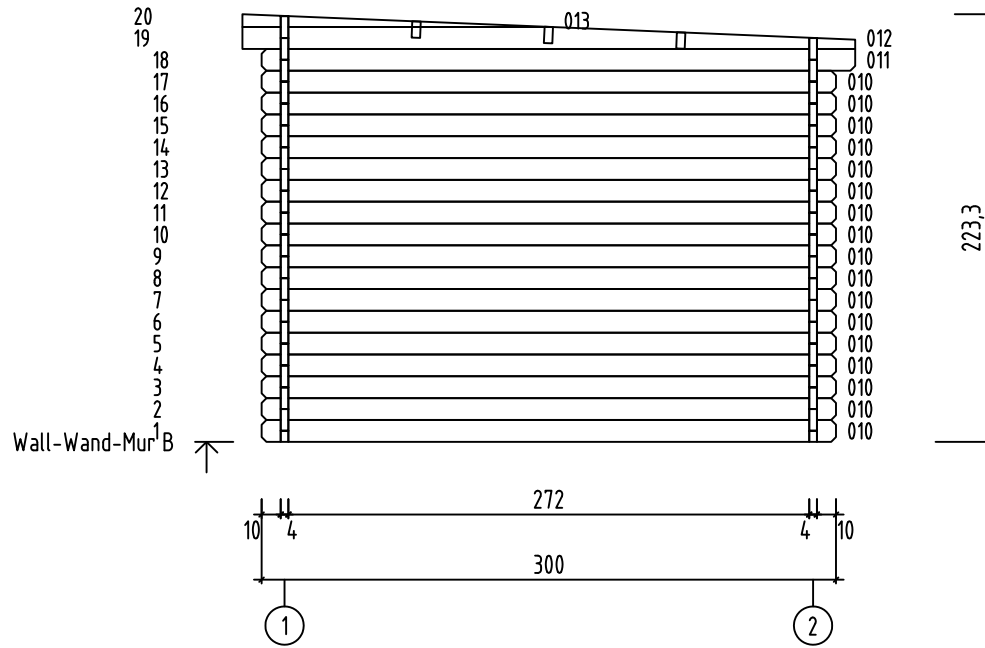
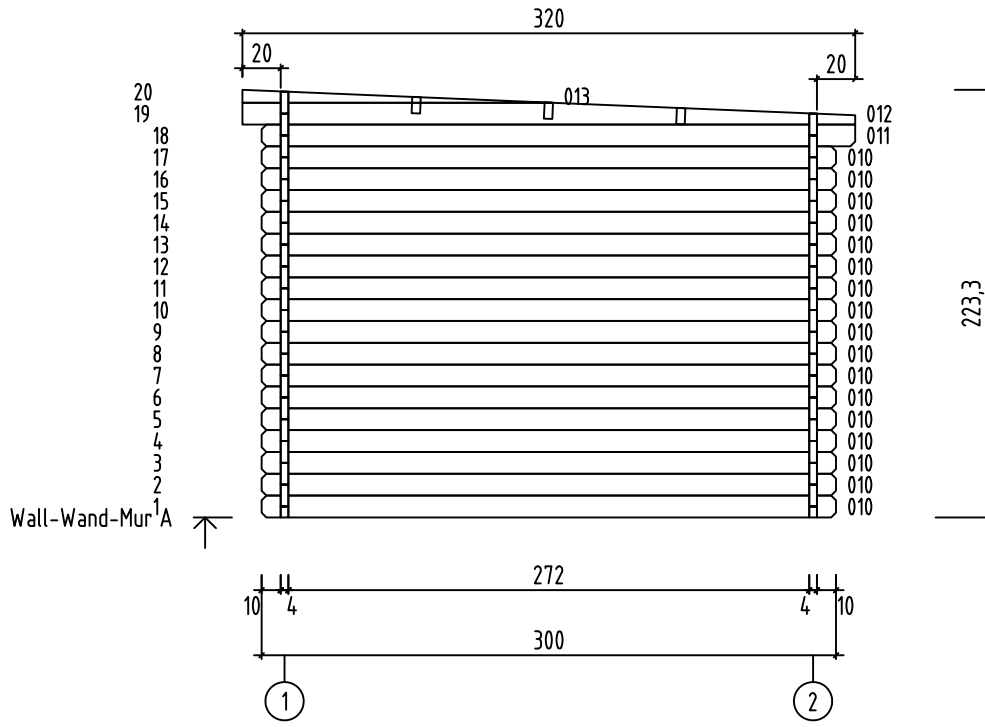



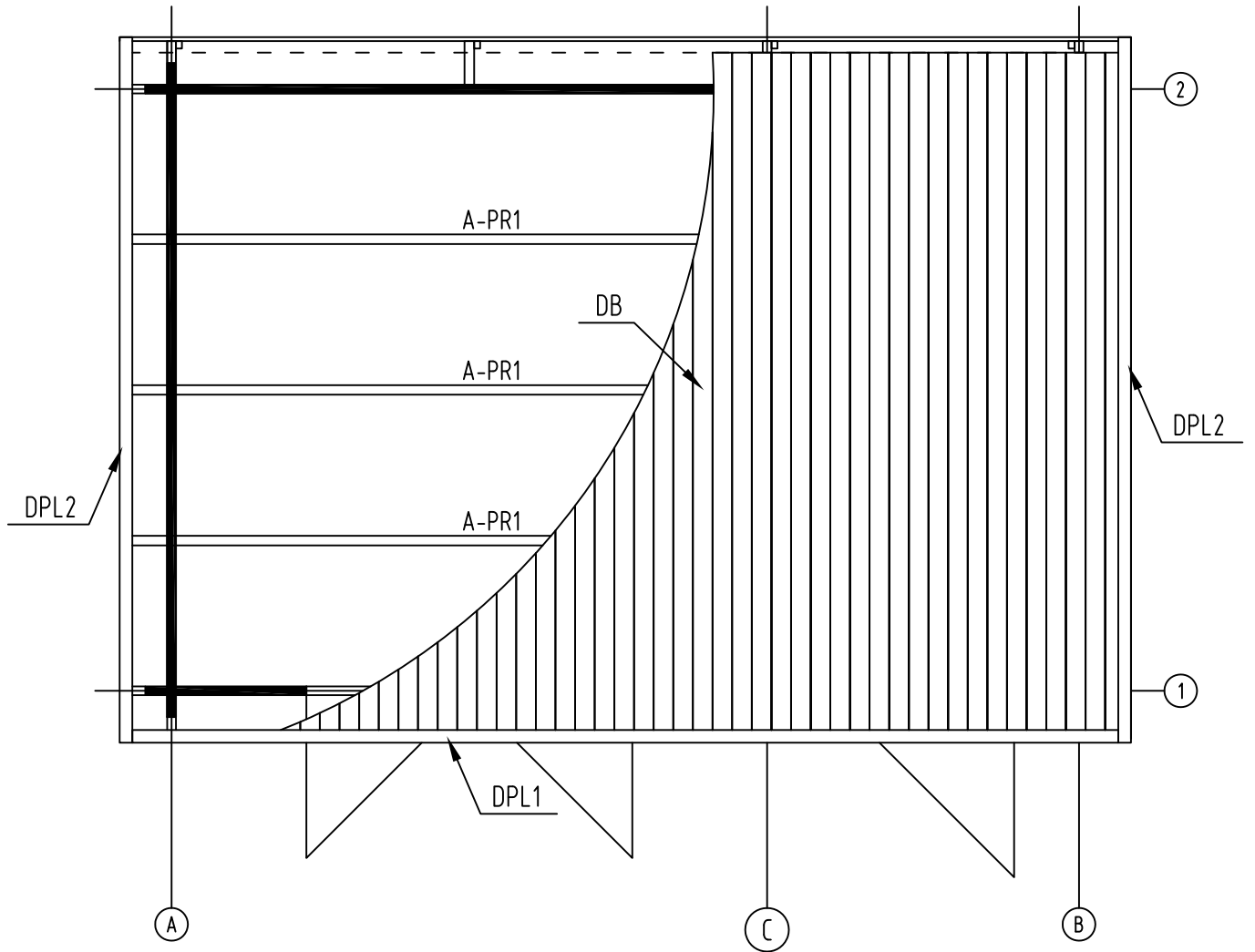



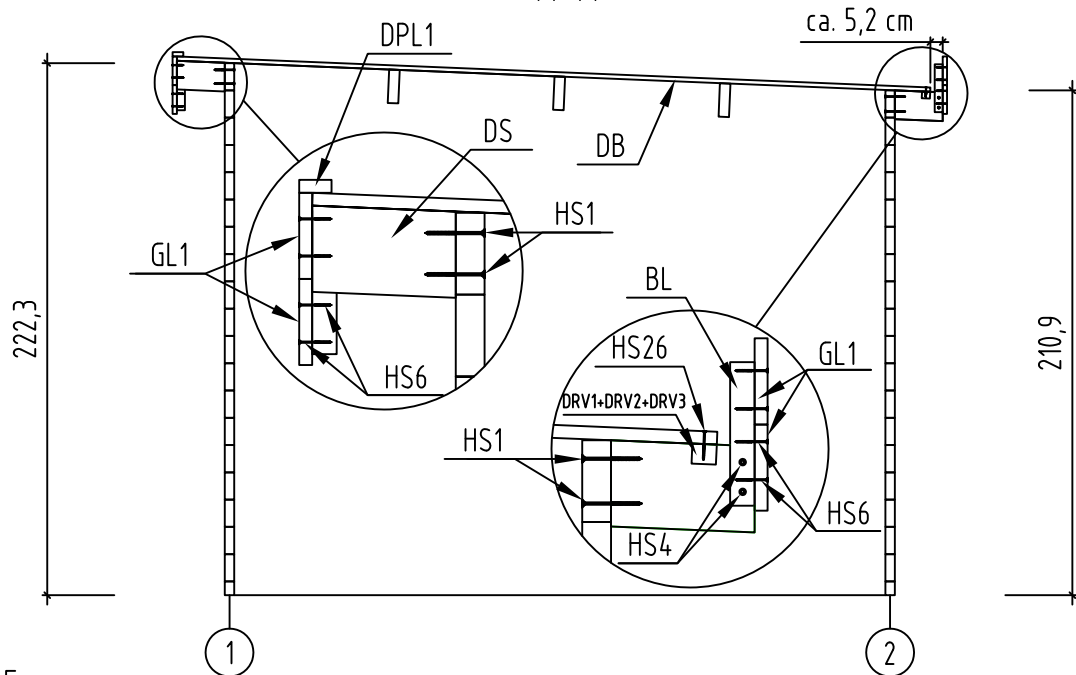

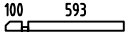
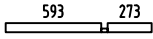

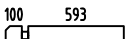
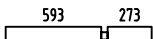

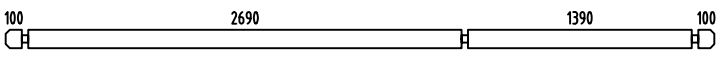
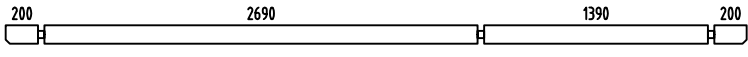
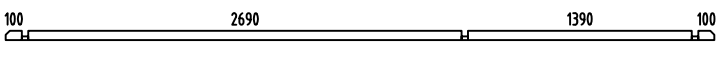
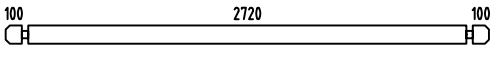
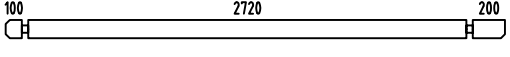
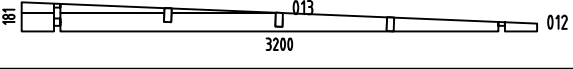
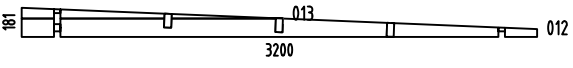
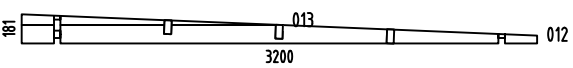
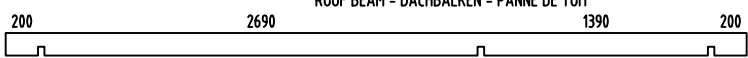

ROOF PLAN - DACH-PLAN - PLAN DU TOIT

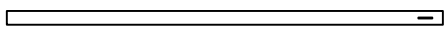

CROSS SECTION - SCHNITT - VU DE COUPE
A-A



Pos	22.12.2015	Piece list - Stückliste - Liste des pièces Art. Nr. 4012096	6/8	Q.	P (mm)	L (mm)
001				1	40x57	733
002				1	40x57	906
003				1	40x57	413
004				16	40x114	733
005				16	40x114	906
006				16	40x114	413
007				19	40x114	4400
008				2	40x114	4600
009				1	40x57	4400
010				51	40x114	3000
011				3	40x114	3100
WA-1				1		
WB-1				1		
WC-1				1		
A-PR1		ROOF BEAM - DACHBALKEN - PANNE DE TOIT		3	44x140	4600
DB	ROOF BOARDS - DACHBRETTER - VOLIGES			52	90x18	3150
DPL2	ROOFING FELT FILLET - DACHPAPPENLEISTE - BAGUETTE DE FIXATION DU FEUTRE BITUMEUX			2	18x58	3236
DPL1	ROOFING FELT FILLET - DACHPAPPENLEISTE - BAGUETTE DE FIXATION DU FEUTRE BITUMEUX			1	18x58	4520
DRV1	ROOF EDGE REINFORCEMENT - DACHRANDVERSTÄRKUNG - CORNIERE DE RENFORT DE BORD DE TOIT			2	28x34	200
DRV2	ROOF EDGE REINFORCEMENT - DACHRANDVERSTÄRKUNG - CORNIERE DE RENFORT DE BORD DE TOIT			2	28x34	1323
DRV3	ROOF EDGE REINFORCEMENT - DACHRANDVERSTÄRKUNG - CORNIERE DE RENFORT DE BORD DE TOIT			1	28x34	1390
KFS	STORM PROTECTION - STURMLEISTE - LATTE ANTI-TEMPETE			4	22x45	2050
BL	FIXING SLAT FOR DISTANCE SPACERS - BEFESTIGUNGSLEISTE - RENFORTS PLANCHES DE RIVES			5	28x34	200
DS	DISTANCE SPACERS FOR GABLE MOULDING - DACHSTÜZEN - SUPPORTS EXTENSION TOITURE			2	44x140	205
GL2	GABLE MOULDING - GIBELLEISTE - PLANCHE DE RIVE			4	18x120	3200

Pos	22.12.2015 Piece list - Stückliste - Liste des pièces Art. Nr. 4012096	8/8	Q.	P (mm)	L (mm)
	DOOR - TÜR- PORTE 1494x1850 SGC <div data-bbox="379 210 1031 976" data-label="Image"> </div>	TUK.1.100.SVV.MMc	1		
	DOOR - TÜR- PORTE 835x1850 MGC <div data-bbox="512 1196 898 1962" data-label="Image"> </div>	UK.1.100.MVP.MMa	1		