

Lisa 6B
Art. Nr. 3413499
1/6

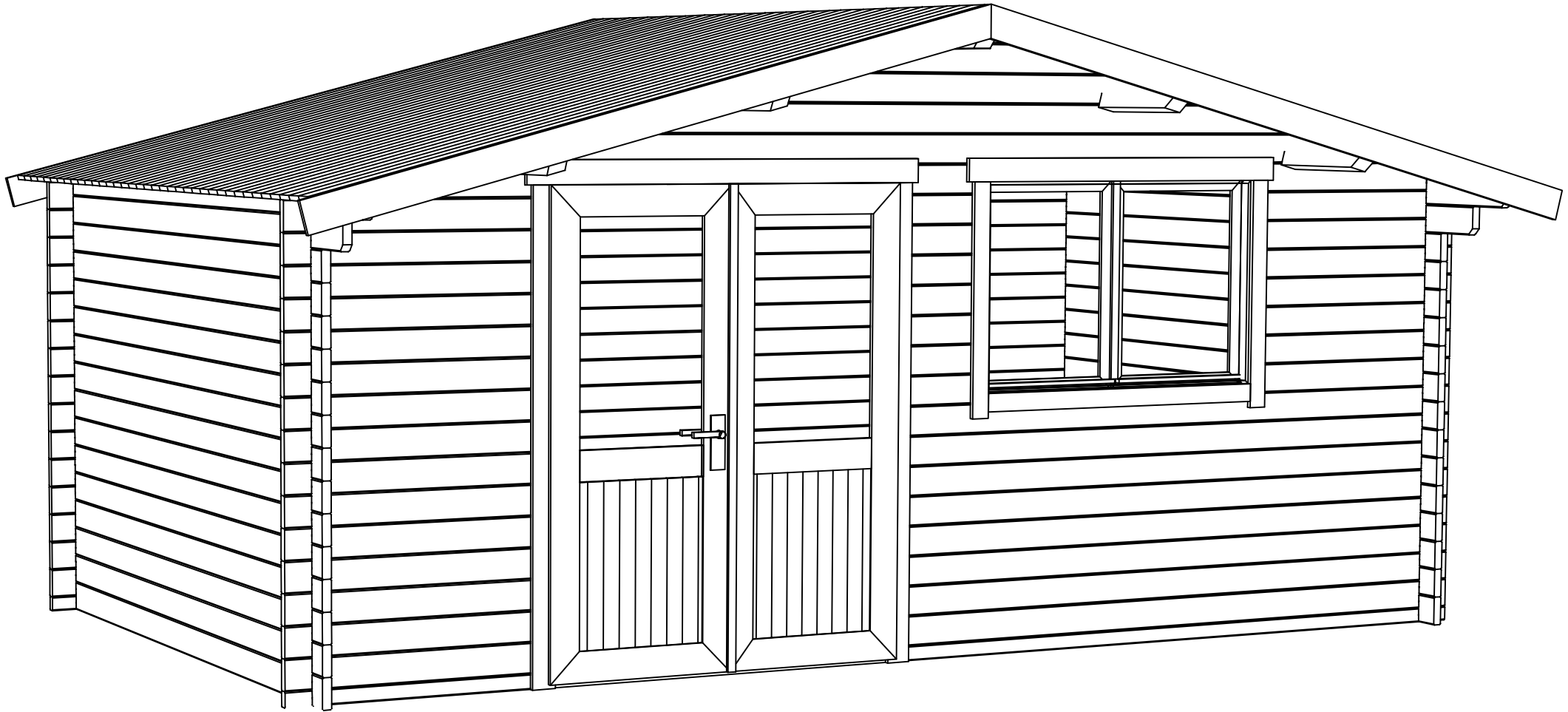

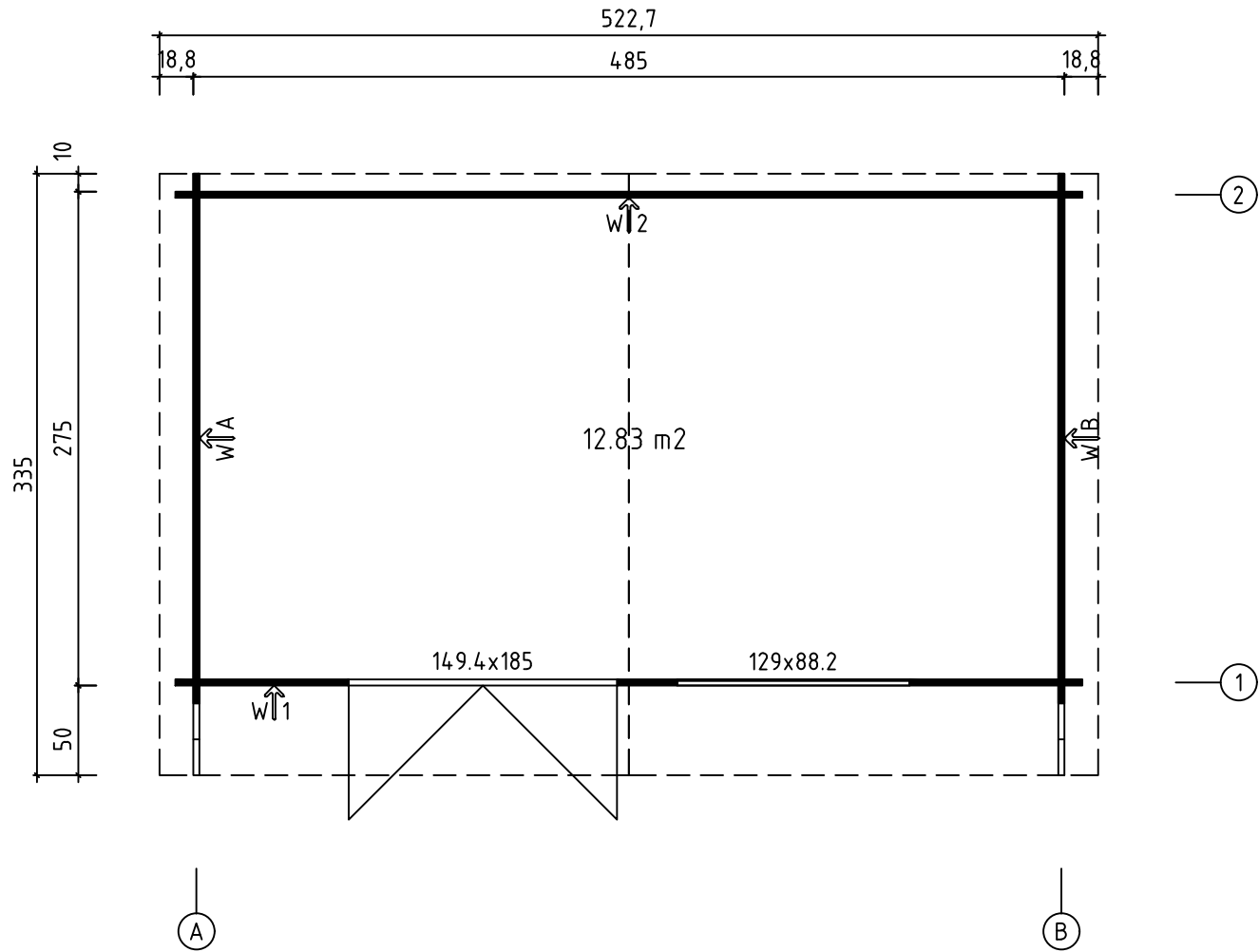





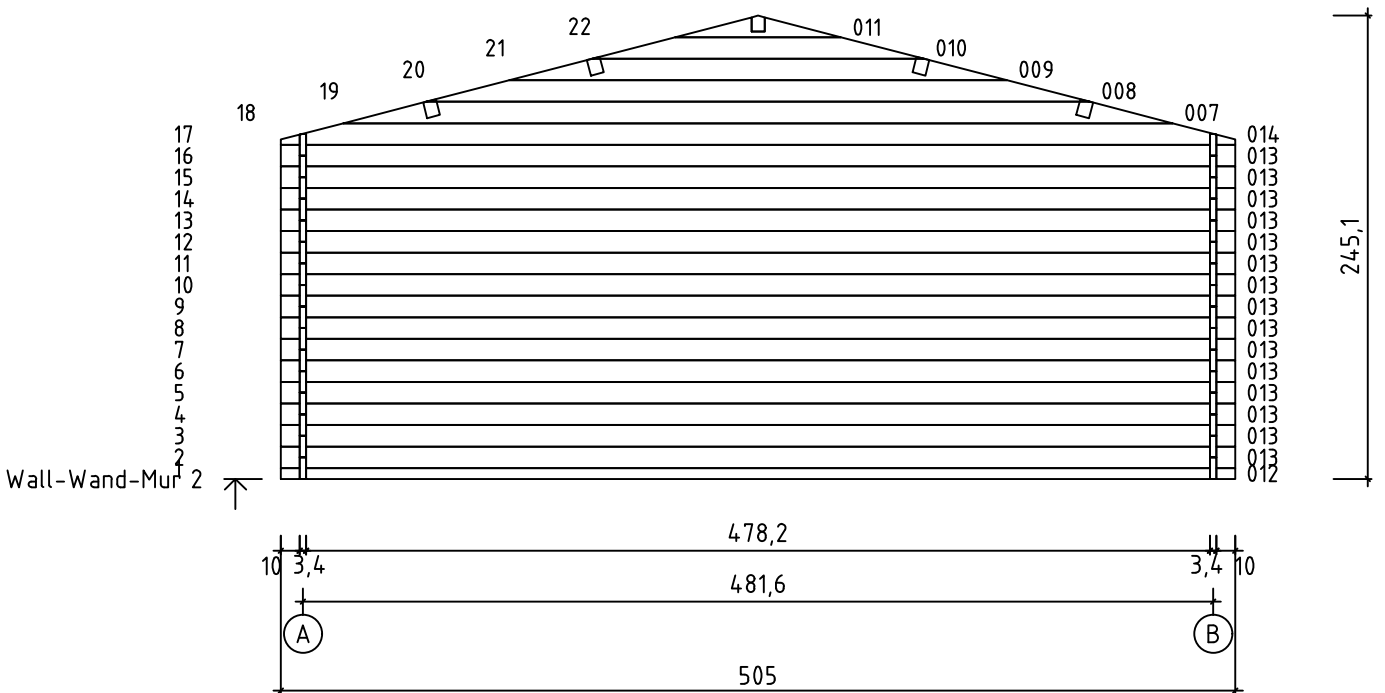
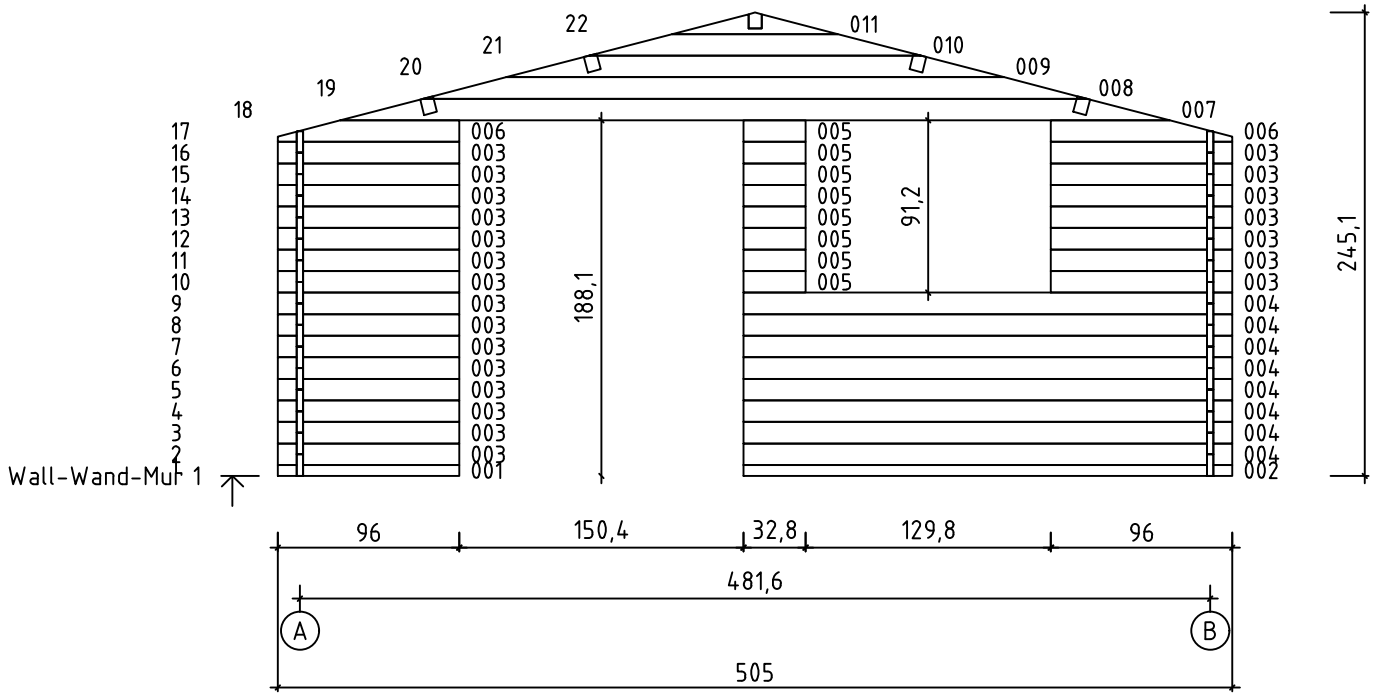

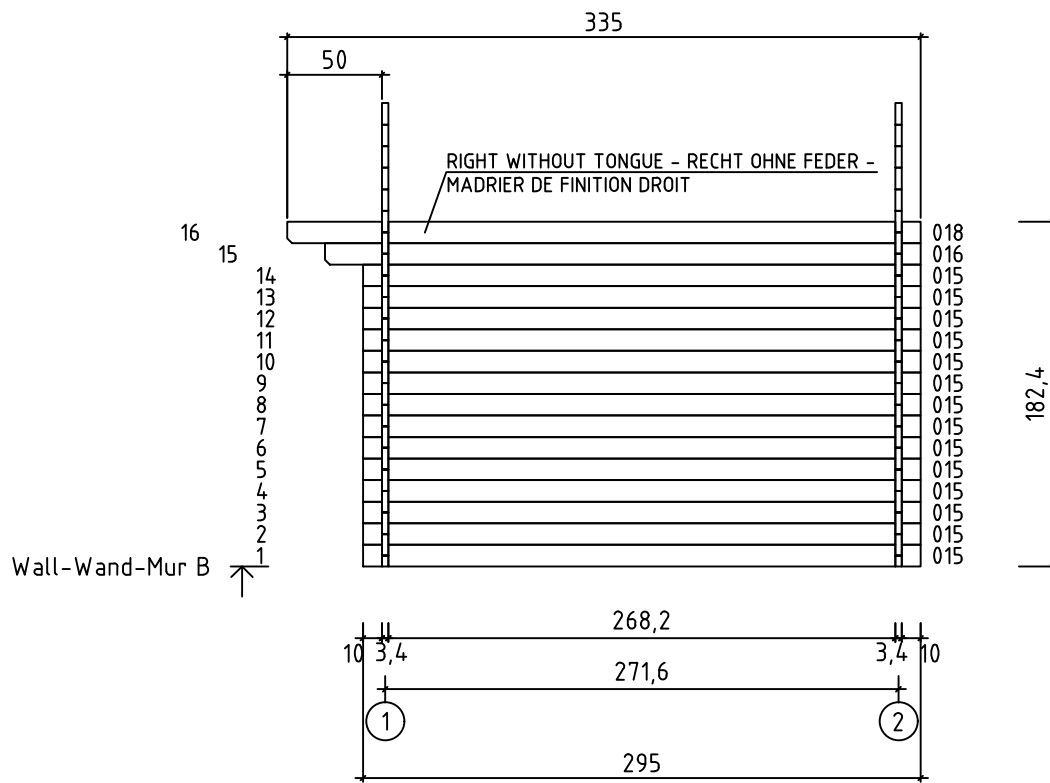
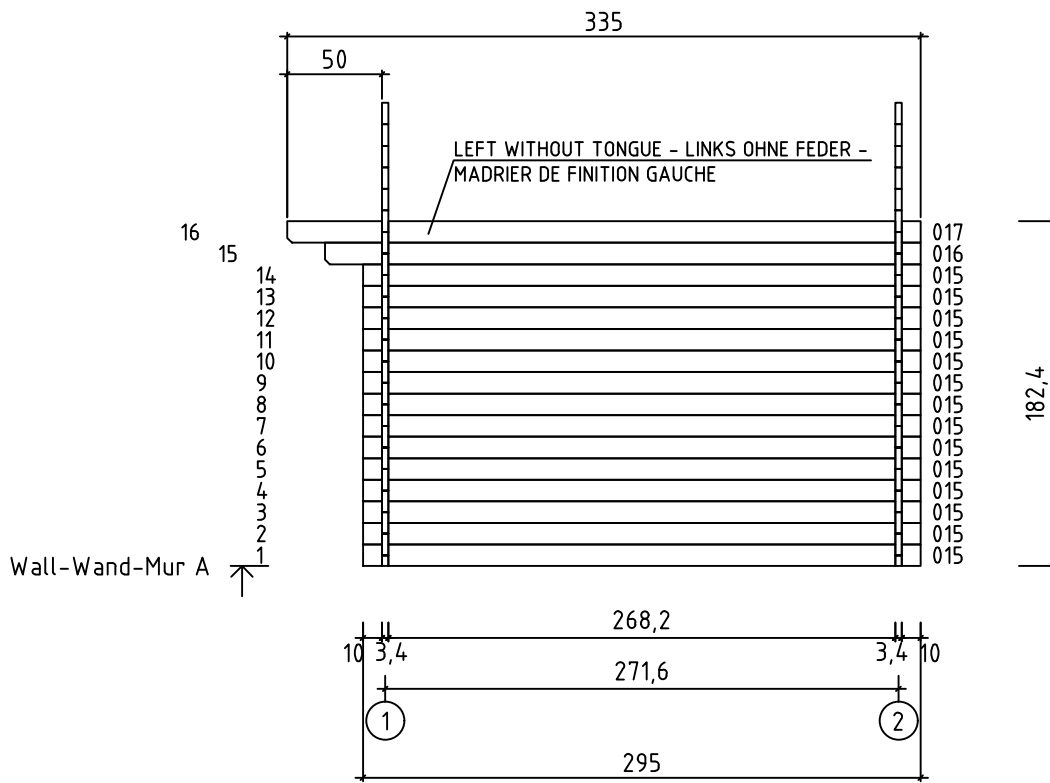
Art. Nr. 3413499

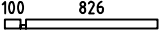
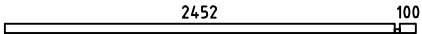
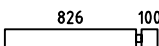
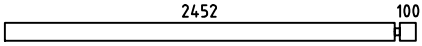
GROUNDPLAN - GRUNDPLAN - PLAN DE MASSE

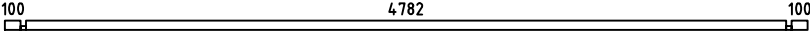
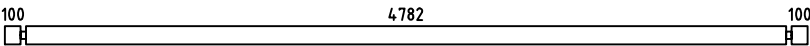
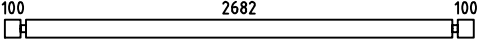
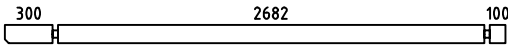
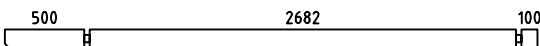
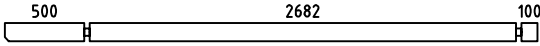
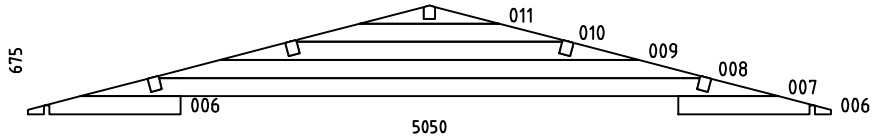
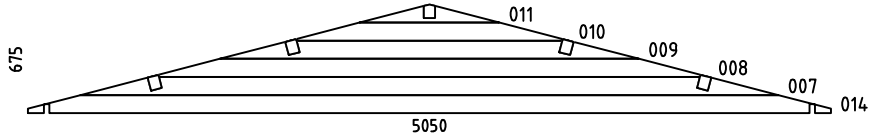
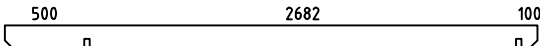
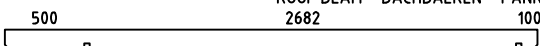

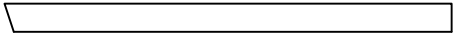

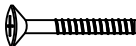
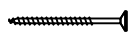
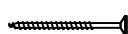

Pos	24.10.2016	Piece list - Stückliste - Liste des pièces Art. Nr. 3413499	5/6	Q	P (mm)	L (mm)
001				1	34x57	960
002				1	34x57	2586
003				22	34x114	960
004				8	34x114	2586
005				8	34x114	328
012				1	34x57	5050
013				15	34x114	5050
015				28	34x114	2950
016				2	34x114	3150
017				1	34x120	3350
018				1	34x120	3350
W1-1				1		
W2-1				1		
PR1	 ROOF BEAM - DACHBALKEN - PANNE DE TOIT			1	70x140	3350
A-PR1	 ROOF BEAM - DACHBALKEN - PANNE DE TOIT			4	70x140	3350
	ROOF BOARDS - DACHBRETTER - VOLIGES			76	90x18	2700
	GABLE MOULDING - GIEBELLEISTE - - PLANCHE DE RIVE			4	18x120	2750
FS1	WINDOW HANDLE FITTINGS - FENSTERGRIFF - POIGNEE DE FENETRE			1		
FSP	BOLT FOR WINDOW HANDLE FITTINGS - BOLZEN FÜR FENSTERGRIFF BESCHLAG - VIS POUR FIXATION POIGNEE DE FENETRE			2		
HS4	SCREW FOR WINDOW FILLET - SCHRAUBE FÜR GLASLEISTE - VIS DE FILET DE FENETRE			3	3x30	
HS4	SCREW FOR DOOR FILLET - SCHRAUBE ZUR BEFESTIGUNG TÜRLEISTE - VIS POUR FIXATION BAGUETTE D'ARRET DE PORTE			5	3x30	
HS16	SCREW FOR DOOR JAMB - SCHRAUBE FÜR TÜRRAHMEN - VIS DE FIXATION PARTIE HAUTE AVEC MONTANTS DU CADRE DE PORTE			4	5x90	
HS25	SCREW FOR DOORSTEP - SCHRAUBEN FÜR SWELLE - VIS POUR FIXATION BARRE DE SEUIL			3	4.5x65	

