

Lorenz
Art. Nr. 403996
1/6

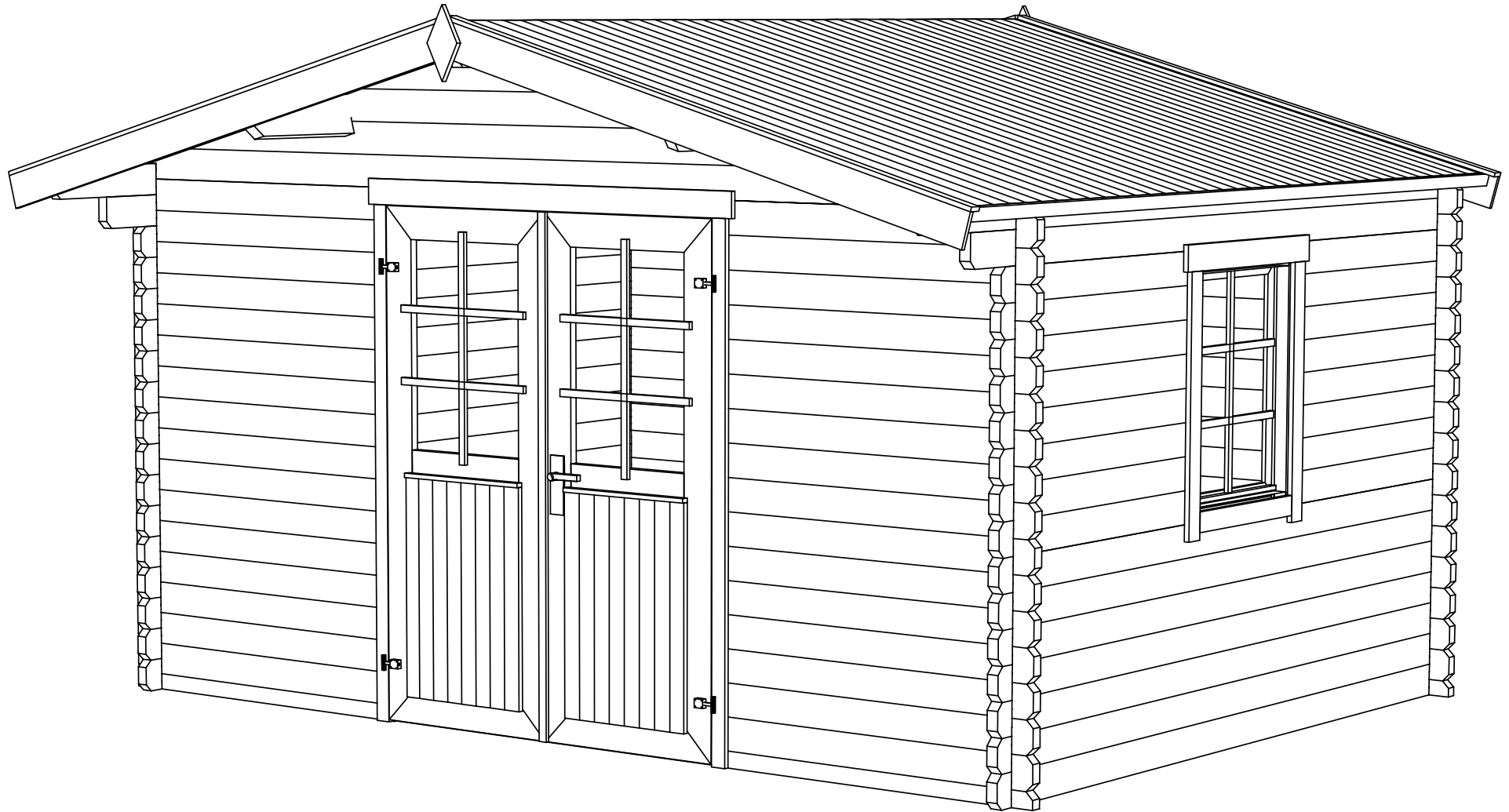

27.02.2015

Art. Nr. 403996



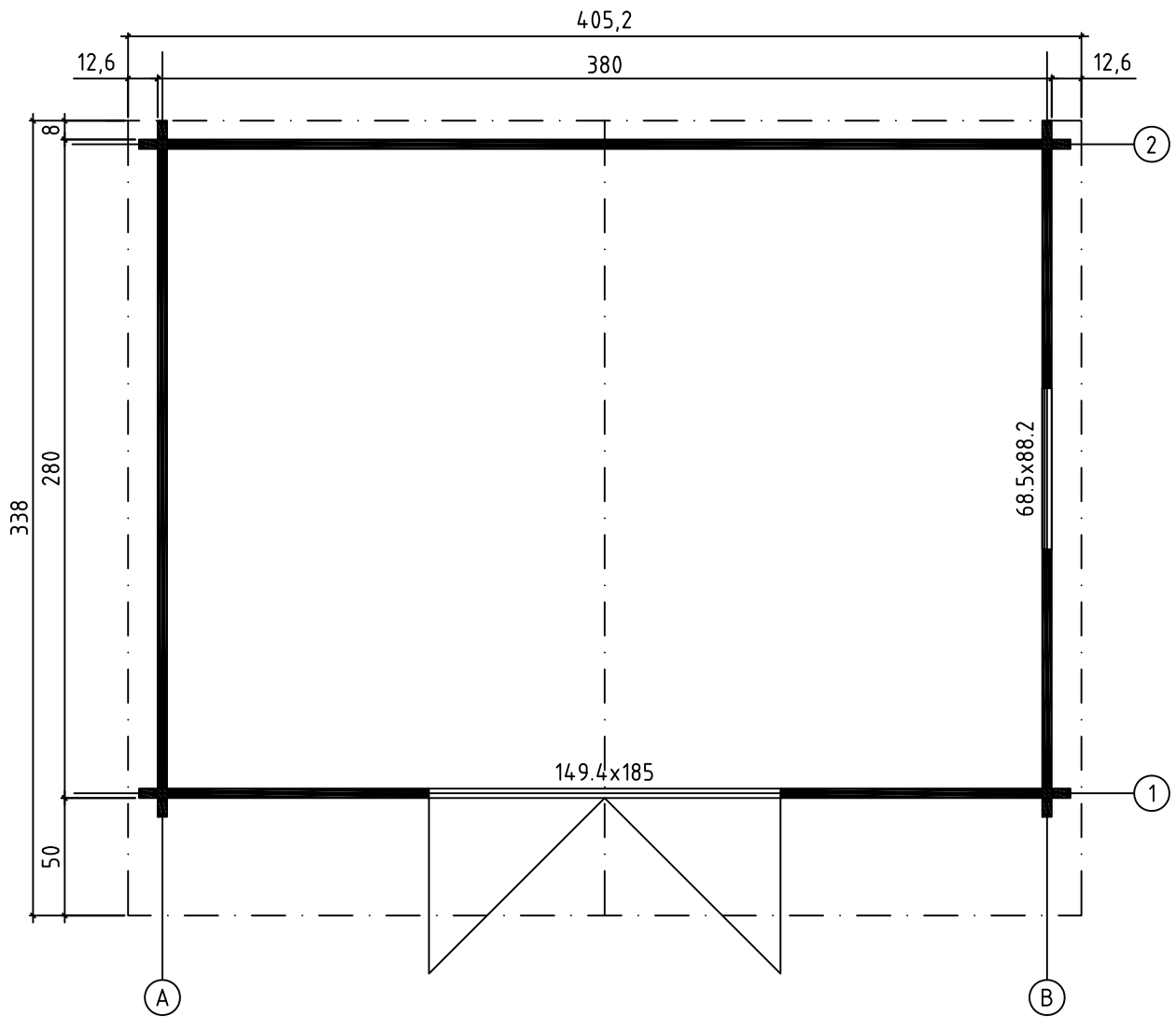



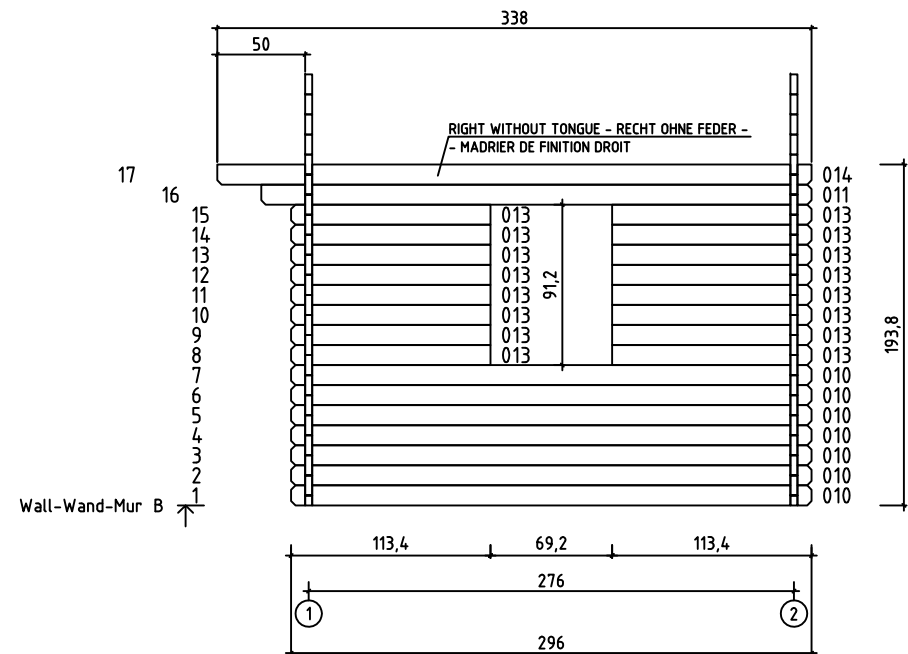
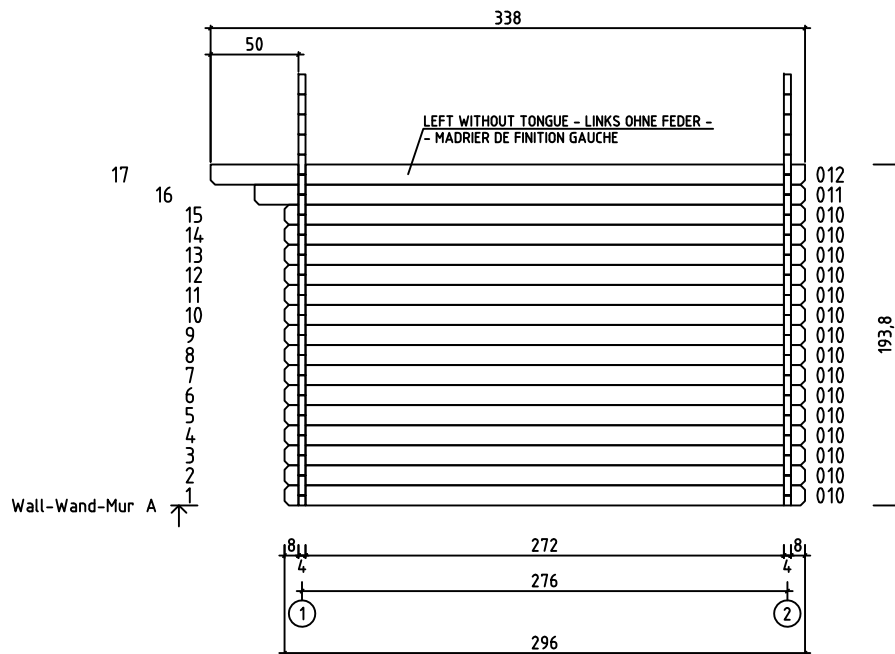
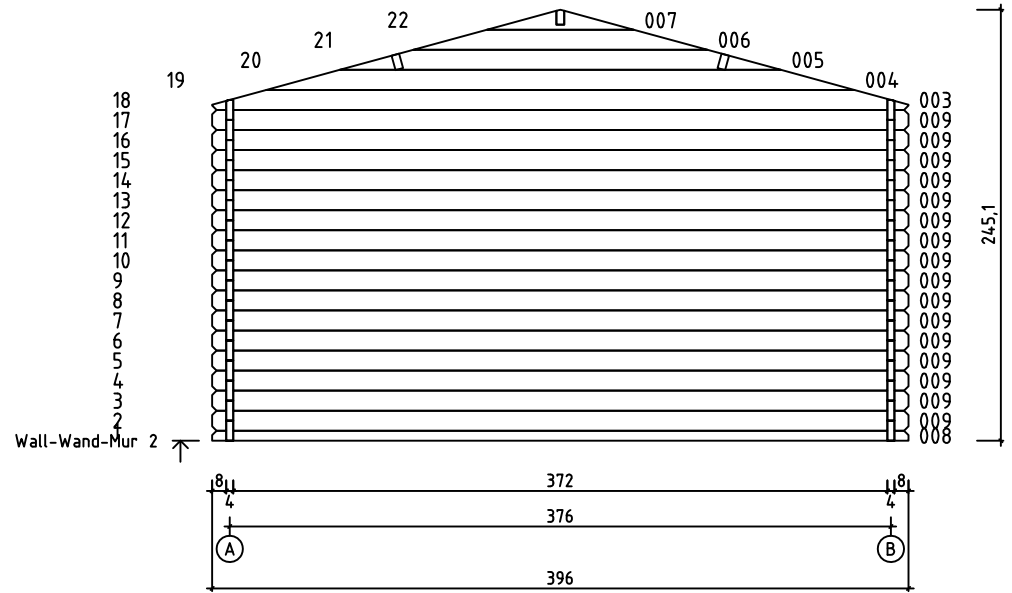
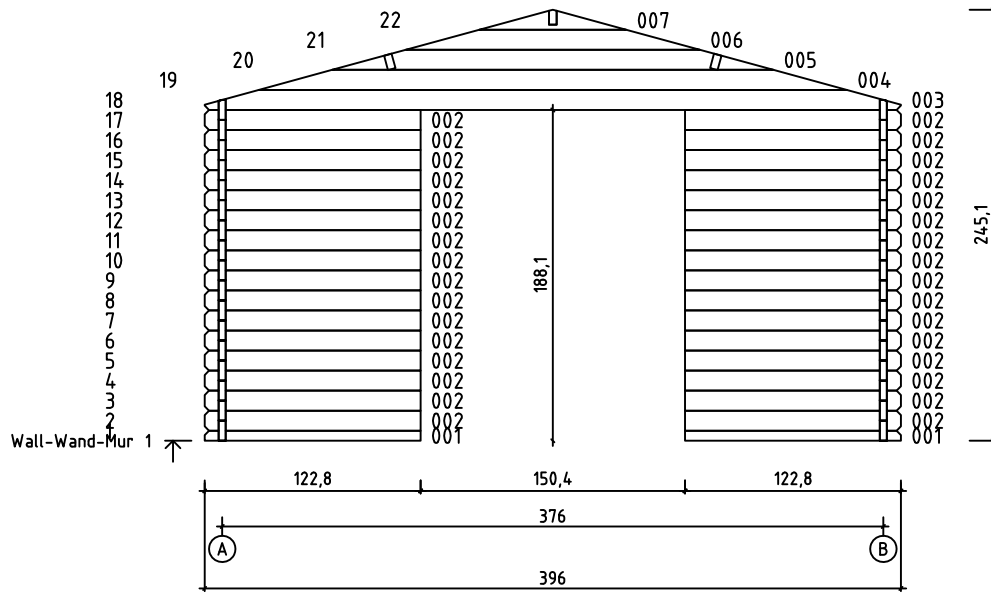



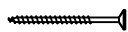

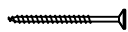

GROUNDPLAN - GRUNDPLAN - PLAN DE MASSE

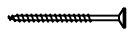



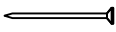
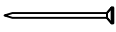
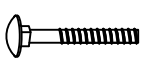

Art. Nr. 403996

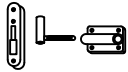
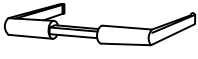
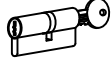
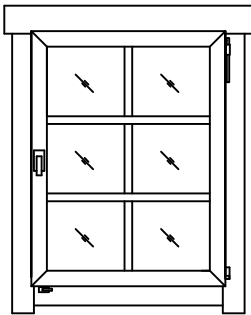

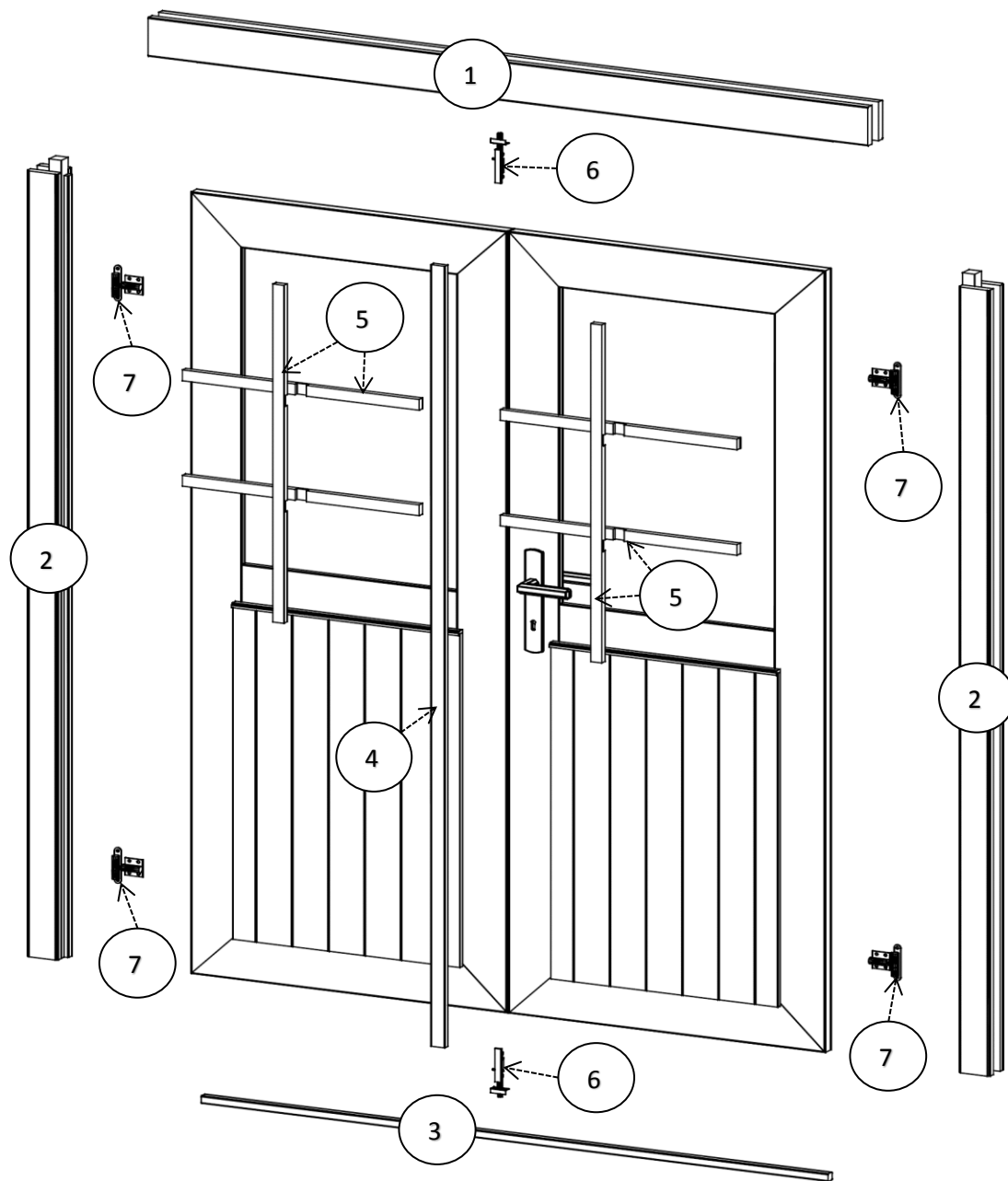
Pos	27.02.2015	Piecelist - Stücklist - Liste des composants Art. Nr. 403996	4/6	Q.	P. (mm)	L. (mm)
001				2	40x57	1228
002				32	40x114	1228
008				1	40x57	3960
009				16	40x114	3960
010				22	40x114	2960
011				2	40x114	3130
012				1	40x120	3380
013				16	40x114	1134
014				1	40x120	3380
W1-1 W2-1				2		
PR1		ROOF BEAM - DACHBALKEN - PANNE DE TOIT		1	44x140	3380
A-PR1		ROOF BEAM - DACHBALKEN - PANNE DE TOIT		2	44x140	3380
	ROOF BOARDS - DACHBRETTER - VOLIGES			76	90x15	2100
	ROOFING FELT FILLET - DACHPAPPENLEISTE - BAGUETTE DE FIXATION DU FEUTRE BITUMEUX			4	15x45	2150
	FASCIA BOARD - TRAUFBRETT - BANDEAU DE TOIT			2	15x45	3380
KFS-1	STORM PROTECTION - STURMLEISTE - LATTE ANTI-TEMPETE			4	22x45	1880
	GABLE MOULDING - GIEBELLEISTE - - PLANCHE DE RIVE			4	15x120	2150
FS	WINDOW HANDLE FITTINGS - FENSTERGRIFF - POIGNÉE D'OUVERTURE DE FENETRE			1		
	BOLT FOR WINDOW HANDLE FITTINGS - BOLZEN FÜR FENSTERGRIFF BESCHLAG - VIS POUR FIXATION POIGNEE DE FENETRE			2		
	SCREW FOR FIXING DOOR TO THE WALL - SCHRAUBE ZUR BEFESTIGUNG TÜR - ZARGE MIT WAND - VIS POUR FIXATION DORMANT DE PORTE AU 1ER RANG DE MADRIER			2	3.5x50	
HS41	SCREW FOR DOOR JAMB - SCHRAUBE FÜR TÜRRAHMEN - VIS POUR FIXATION MONTANT DE PORTE			2	4x60	
HS43	SCREW FOR ROOF BEAMS - SCHRAUBEN FÜR DACHBALKEN - VIS POUR FIXATION PANNES DE TOIT			10	5x120	
	SCREW FOR GEORGIAN BARS - SCHRAUBE FÜR SPROSSEN - VIS POUR FIXATION CROISILLONS BOIS DES MENUISERIES			18	2.5x20	
	SCREW FOR GABLE SEGMENT - SCHRAUBEN FÜR DECKBLATT - VIS POUR FIXATION LOSANGE DE FINITION			4	3.5x35	

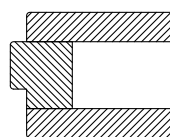
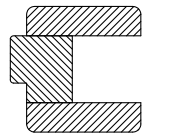
Pos	27.02.2015	Piecelist - Stücklist - Liste des composants Art. Nr. 403996	5/6	Q.	P. (mm)	L. (mm)
		SCREW FOR GABLE MOULDING - SCHRAUBEN FÜR GIEBELLEISTE - VIS POUR FIXATION PLANCHE DE RIVE		24	3.5x50	
		SCREW FOR DOOR FILLET - SCHRAUBE ZUR BEFESTIGUNG TÜRLEISTE - VIS POUR FIXATION BAGUETTE D'ARRET DE PORTE		5	3x30	
		SCREW FOR DOORSTEP - SCHRAUBEN FÜR SWELLE - VIS POUR FIXATION BARRE DE SEUIL		3	3x30	
		SCREW FOR FIXING BOLT HINGE - SCHRAUBE FÜR TÜRRIEDEL - VIS POUR FIXATION GONDS DE PORTE - POUR OUVRANT		16	4x30	
		SCREW FOR FASCIA BOARDS - SCHRAUBEN FÜR TRAUFBRETTEN - VIS POUR FIXATION BANDEAU DE TOIT		16	4x40	
		SCREW FOR FIXING BOLT HINGE - SCHRAUBE FÜR TÜRRIEDEL - VIS POUR FIXATION GONDS DE PORTE - POUR OUVRANT		12	4x40	
		SCREW FOR DOOR JAMB - SCHRAUBE FÜR TÜRRAHMEN - VIS POUR FIXATION MONTANT DE PORTE		2	5x90	
		SET OF DOOR LOCK COVERS - SCHLOSSBLENDEN - SET DE GARNITURES DE PORTE		1		
SH40		HAMMER BLOCK - SCHLAGHOLZ - CALLE DE FRAPPE		1		
SFS		NUT FOR STORM PROTECTION - SCHRAUBENMUTTER FÜR STURMLEISTE - ECROU POUR LATTE ANTI-TEMPETE		8	D6	
NF2		ZN NAIL FOR ROOF - ZN NÄGEL FÜR DACHBRETTEN - POINTE POUR FIXATION VOLIGES DE TOIT		242	2x50	
NFD		ZN NAIL FOR ROOFING FELT FILLET - ZN NÄGEL FÜR DACHPAPPENLEISTE - POINTE POUR BAGUETTE DE FIXATION FEUTRE BITUMEUX		20	2x40	
BFS		BOLT FOR STORM PROTECTION - BOLZEN FÜR STURMLEISTE - BOULON POUR LATTE ANTI-TEMPETE		8	6x70	
TL		LATCH BOLT FOR DOUBLE DOOR - TORRIEGEL - LOQUET POUR DOUBLE PORTE		2		
GS		GABLE SEGMENT - DECKBLATT - LOSANGE DE FINITION		2		
DFS		WASHER FOR STORM PROTECTION - DICHTSCHEIBE FÜR STURMLEISTE - RONDELLE POUR LATTE ANTI-TEMPETE		8	D6	
		MALE BOLT HINGE FOR DOOR - TÜRRIEDEL - PARTIE MALE DE PAUMELLE DE PORTE		4	DIN15-57	
		DOOR HANDLE FITTINGS - TÜRGRIF - POIGNEE DE PORTE		1		
		CYLINDER LOCK - ZYLINDERSCHLOSS - BARILLET DE PORTE		1	30/30	
		WINDOW - FENSTER - FENETRE 685x882 SGC	AK.1.106.SSP.d	1		
						

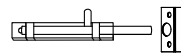
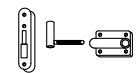

Pos	Piece list - Stückliste - Liste des pièces	Q.	P (mm)
1		1	77x100
2		2	77x80
3		1	18x29
4		1	13x32
5		6	15x25
6		2	
7		4	

