

Nele 7
Art. Nr. 4010000
1/7

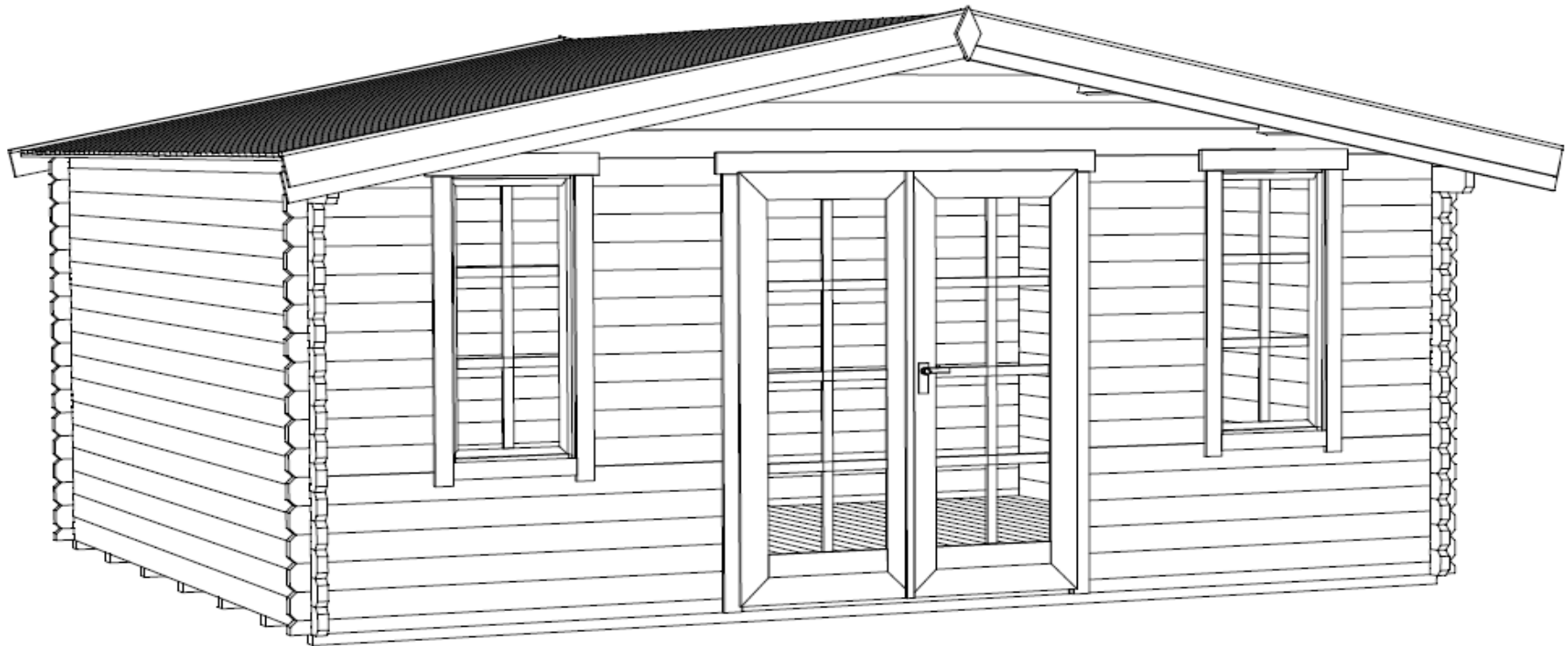

GROUNDPLAN - GRUNDPLAN - PLAN DE MASSE

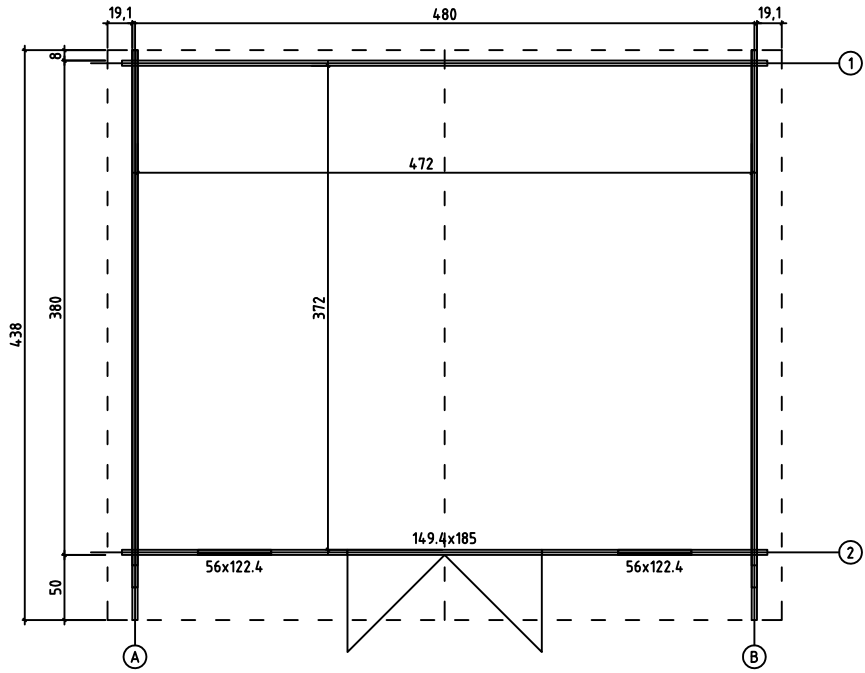

FOUNDATION - FUNDAMENT - FONDATION

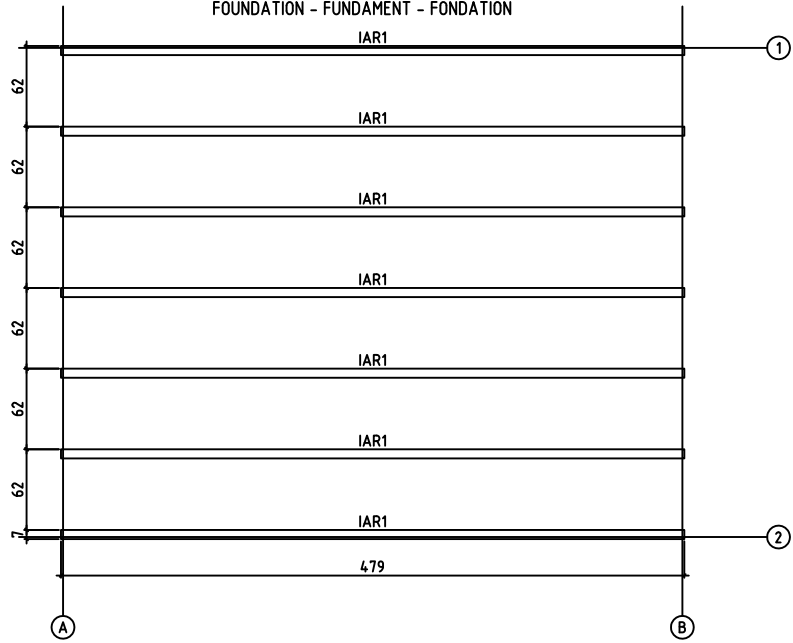



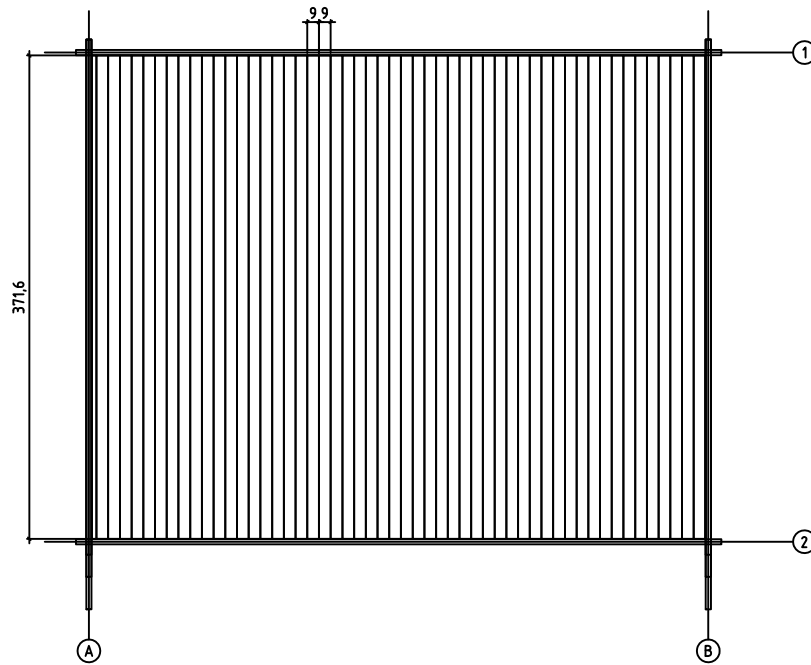

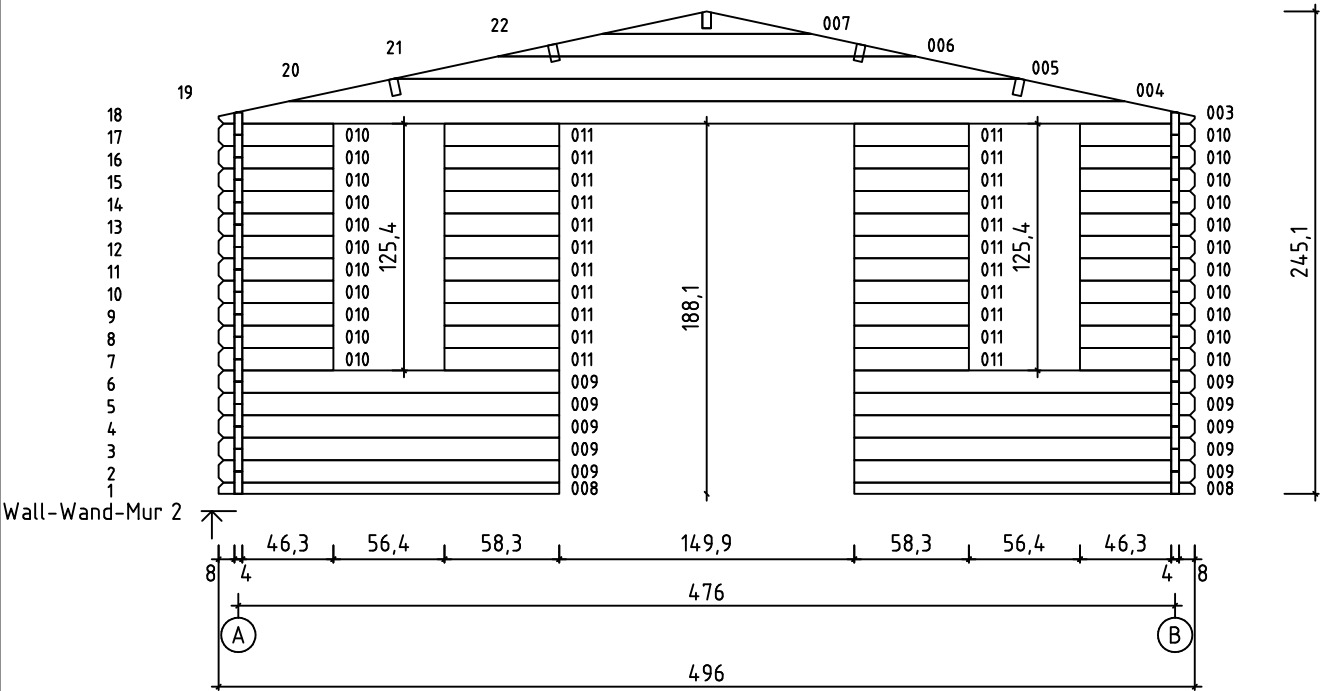
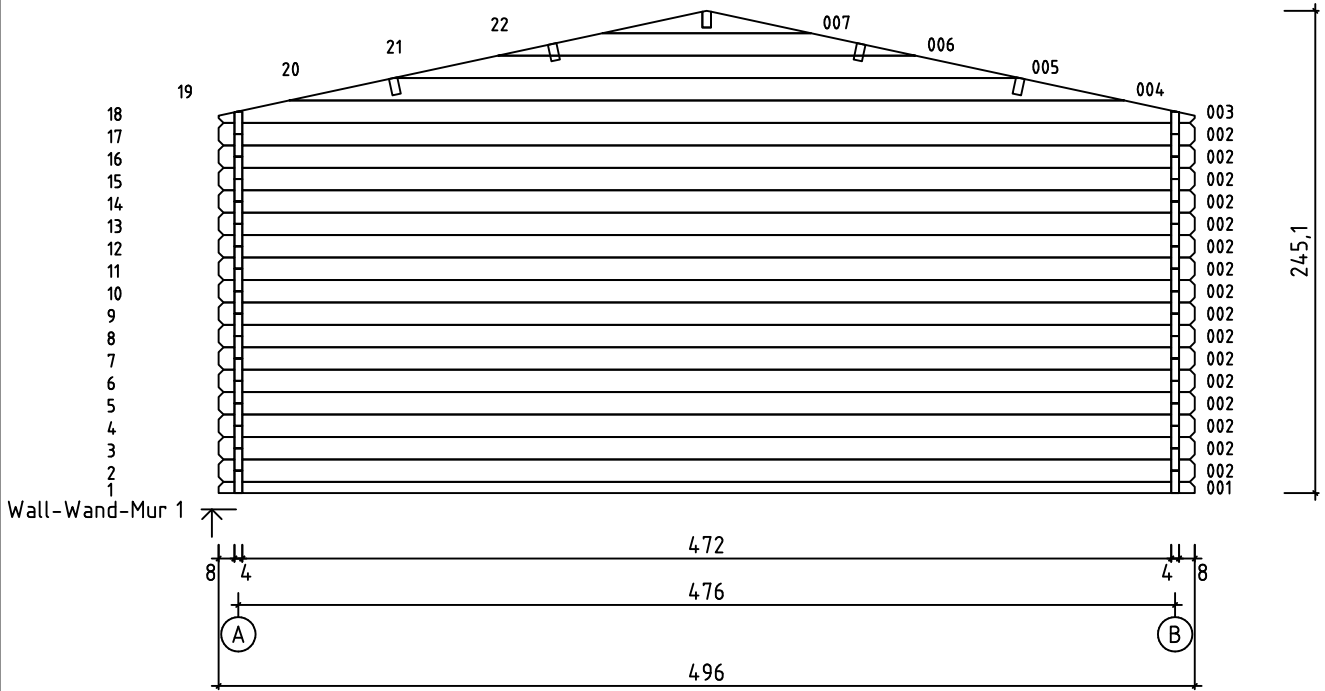

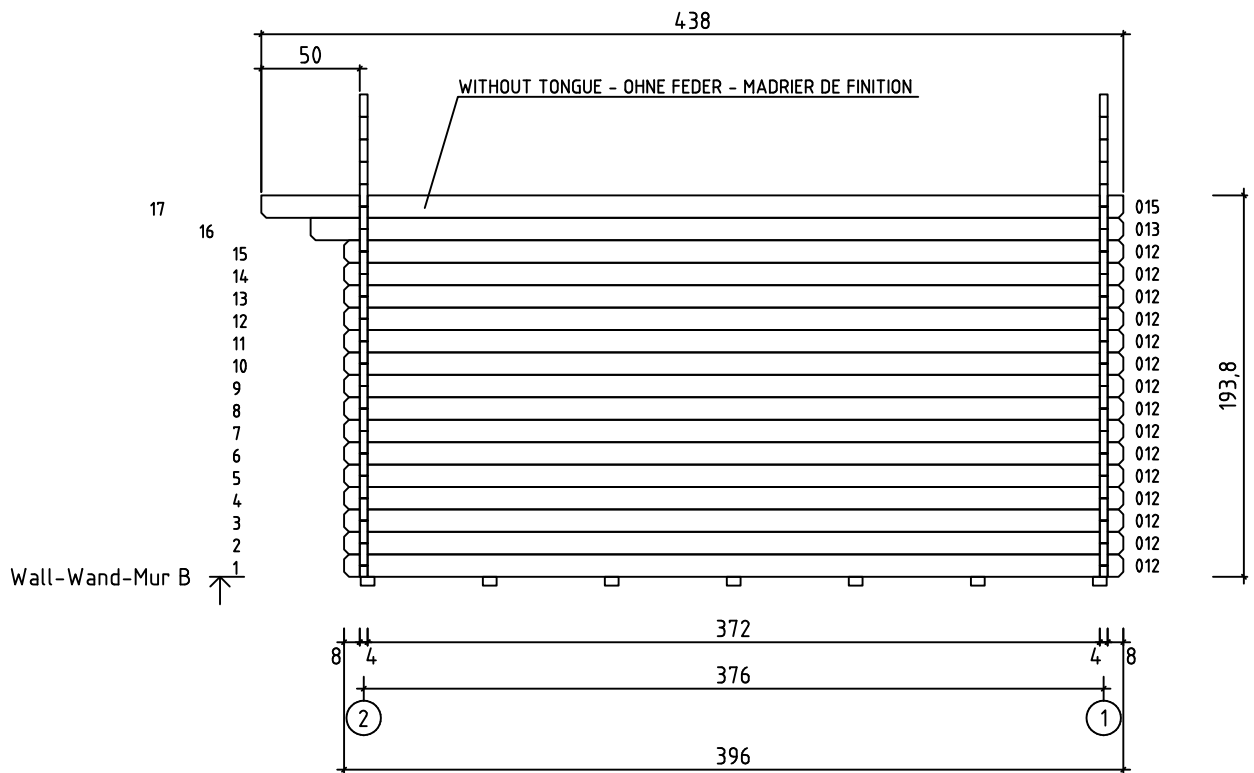
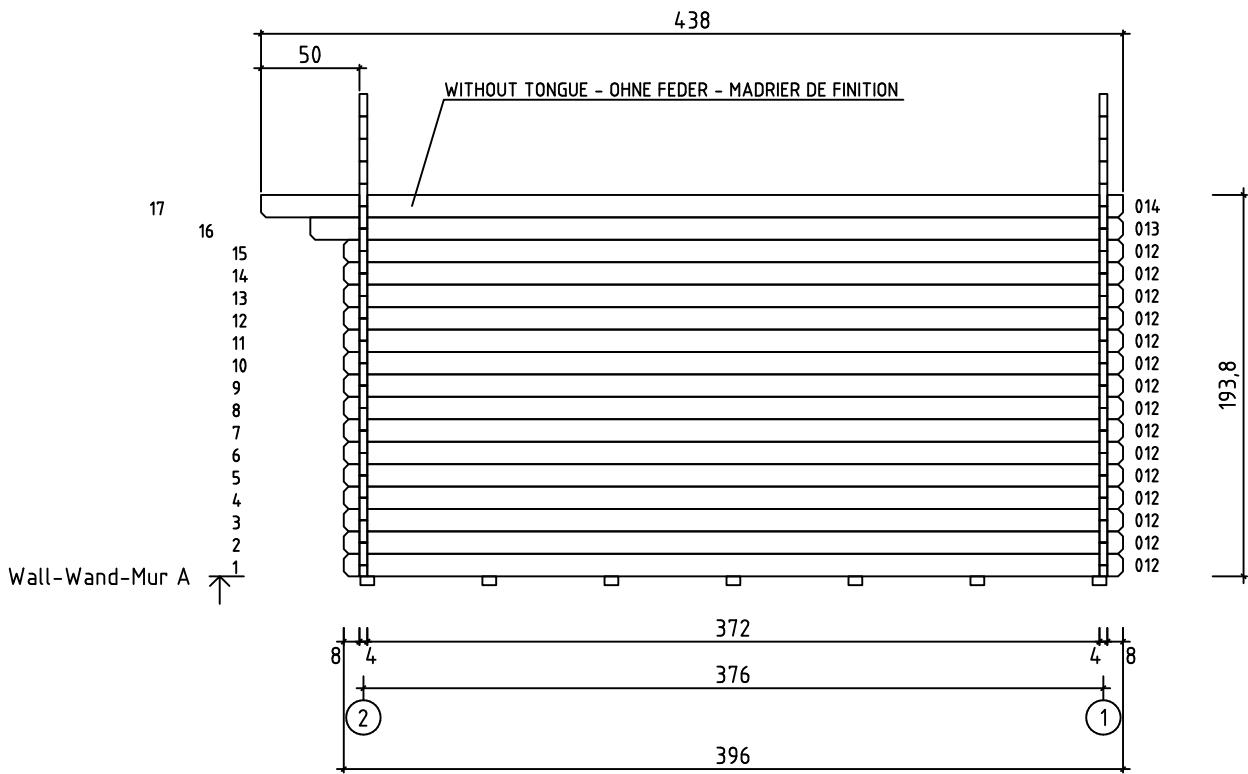





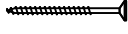
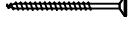

FLOOR BOARDS - FUSSBODENBRETTER - PLAN POSE PLANCHER

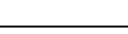

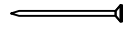
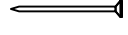

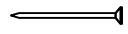
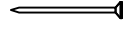
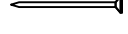
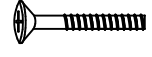

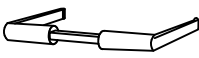
Pos	25.07.2014	Piece list - Stückliste - Liste des pièces Art. nr. 4010000	5/7	Q.	P (mm)	L (mm)
001				1	40x57	4960
002				16	40x114	4960
008				2	40x57	1731
009				10	40x114	1731
010				22	40x114	583
011				22	40x114	583
012				30	40x114	3960
013				2	40x114	4130
014				1	40x120	4380
015				1	40x120	4380
W1-1 W2-1				1 1		
IAR1	FOUNDATION - FUNDAMENT - FONDATION			7	70x45	4790
PR1	ROOF BEAM - DACHBALKEN - PANNE DE TOIT			1	44x140	4380
A-PR1	ROOF BEAM - DACHBALKEN - PANNE DE TOIT			4	44x140	4380
	FLOOR BOARDS - FUSSBODENBRETTER - LAME DE PLANCHER			53	90x18	3716
	ROOF BOARDS - DACHBRETTER - VOLIGES			98	90x15	2650
	FLOOR FILLET-FUSSBODENLEISTE - CORNIERE DE FINITION DU PLANCHER				18x18	16.86
	ROOFING FELT FILLET - DACHPAPPENLEISTE - BAGUETTE DE FIXATION DU FEUTRE BITUMEUX			4	15x45	2700
	ROOF EDGE REINFORCEMENT - DACHRANDVERSTÄRKUNG - CORNIERE DE RENFORT DE BORD DE TOIT			2	15x45	4380
	STORM PROTECTION - STURMLEISTE - LATTE ANTI-TEMPETE			4	22x45	1850
	GABLE MOULDING - GIEBELLEISTE - PLANCHE DE RIVE			6	18x120	2700
	WINDOW HANDLE FITTINGS-FENSTERGRIFF - POIGNÉE D'OUVERTURE DE FENETRE			2		
	BOLT FOR WINDOW HANDLE FITTINGS - BOLZEN FÜR FENSTERGRIFF BESCHLAG - BOULON POUR POIGNÉE D'OUVERTURE DE FENETRE			4		

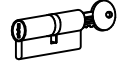
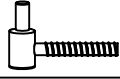
Pos	25.07.2014	Piece list - Stückliste - Liste des pièces Art. nr. 4010000	6/7	Q.	P (mm)	L (mm)
		SCREW FOR GABLE SEGMENT - SCHRAUBEN FÜR DECKBLATT - VIS POUR FIXATION LOSANGE DE FINITION		4	3.5x35	
		SCREW FOR GABLE MOULDING - SCHRAUBEN FÜR GIEBELLEISTE - VIS DE FIXATION POUR PLANCHE DE RIVE		48	3.5x50	
		SCREW FOR ROOF EDGE REINFORCEMENT - SCHRAUBEN FÜR DACHRANDVERSTÄRKUNG - VIS POUR RENFORT DE BORD DE TOIT		20	3x30	
		SCREW FOR DOOR FILLET - SCHRAUBE ZUR BEFESTIGUNG TÜRLEISTE - VIS D'ASSEMBLAGE DU CADRE DE PORTE		5	3x30	
		SCREW FOR ROOF BEAMS - SCHRAUBEN FÜR DACHBALKEN - VIS POUR PANNE DE TOIT		14	5x120	
		SCREW FOR 1. WALL BEAM - SCHRAUBE FÜR 1. BOHLENREIHE - VIS DE FIXATION DES FONDATIONS		8	5x90	
		SCREW FOR DOOR JAMB - SCHRAUBE FÜR TÜRRAHMEN - VIS DE FIXATION POUR MONTANT DE PORTE		4	5x90	
		SCREW FOR DOORSTEP - SCHRAUBEN FÜR SWELLE - VIS DE FIXATION DU SEUIL DE PORTE		3	4.5x65	
		WINDOW/DOOR CROSS SLOT STRAIGHT (PLASTIC) - FENSTER/TÜREN EISENWAREN - QUINCAILLERIE POUR PORTES ET FENÊTRES		28		
		NAIL FOR WINDOW/DOOR CROSS SLOT STRAIGHT - NÄGEL FÜR FENSTER/TÜREN EISENWAREN - POINTE POUR QUINCAILLERIE POUR PORTES ET FENÊTRES		56	1.4x30	
		ZN NAIL FOR FLOOR FILLET - ZN NÄGEL FÜR FUSSBODENLEISTE - POINTE POUR CORNIERE DE FINITION DU PLANCHER		34	1.4x40	
		HAMMER BLOCK - SCHLAGHOLZ - CALLE DE FRAPPE		1		
		NUT FOR STORM PROTECTION - SCHRAUBENMUTTER FÜR STURMLEISTE - ÉCROU POUR LAME ANTI-TEMPÊTE		8		
		ZN NAIL FOR ROOF - ZN NÄGEL FÜR DACHBRETTER - POINTE POUR TOIT		412	2x50	
		ZN NAIL FOR FLOOR - ZN NÄGEL FÜR FUSSBODENBRETTER - CLOUS POUR PLANCHER		378	2x50	
		ZN NAIL FOR ROOFING FELT FILLET - ZN NÄGEL FÜR DACHPAPPENLEISTE - POINTE POUR BAGUETTE FIXATION FEUTRE BITUMEUX		28	2x40	
		BOLT FOR STORM PROTECTION - BOLZEN FÜR STURMLEISTE - VIS POUR LAME ANTI-TEMPÊTE		8		
		GABLE SEGMENT-DECKBLATT - LOSANGE DE FINITION		2		
		WASHER FOR STORM PROTECTION - DICHTSCHEIBE FÜR STURMLEISTE - RONDELLE POUR LAME ANTI-TEMPÊTE		8		
		DOOR HANDLE FITTINGS - TÜRGRIFF - SET DE GARNITURES DE SERRURE DE PORTE		1		
		DOOR LOCK COVER - SCHLOSSBLENDE - GARNITURE DE SERRURE DE PORTE		1		
		CYLINDER LOCK - ZYLINDERSCHLOSS - CYLINDRE DE SERRURE		1		
		MALE BOLT HINGE FOR DOOR - TÜRRIEGEL - PARTIE MALE DE CHARNIERE DE PORTE		6		

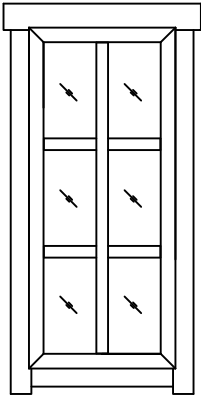
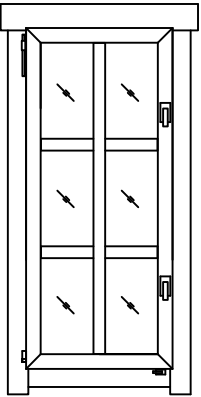
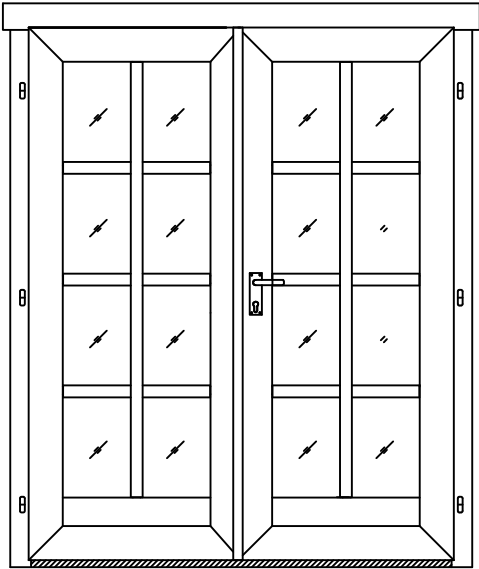

Pos	25.07.2014 Piece list - Stückliste - Liste des pièces Art. nr. 4010000	7/7	Q.	P (mm)	L (mm)
	WINDOW - FENSTER - FENETRE 560x1224 AK.1.106.SM0.Pf SGC+E 	1			
	WINDOW - FENSTER - FENETRE 560x1224 AK.1.106.SSV.Pf SGC+E 	1			
	DOOR - TÜR - PORTE 1494x1850 TUK.1.108.SVP.MMPc SGC+E 	1			

A=A

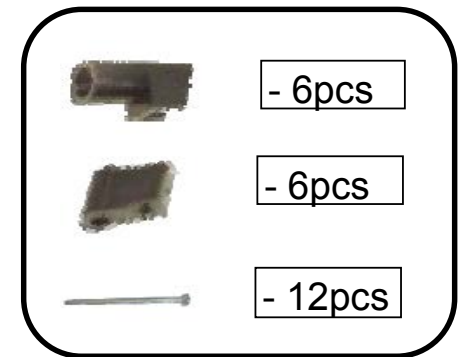
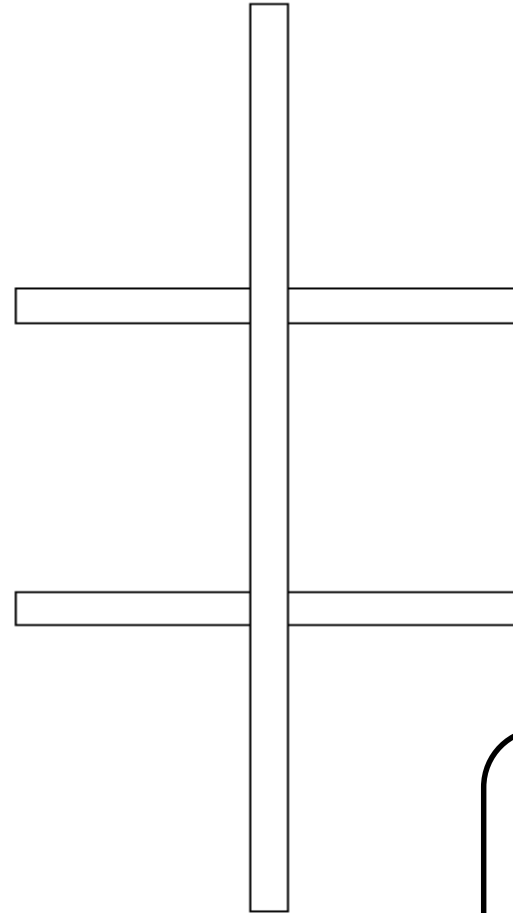
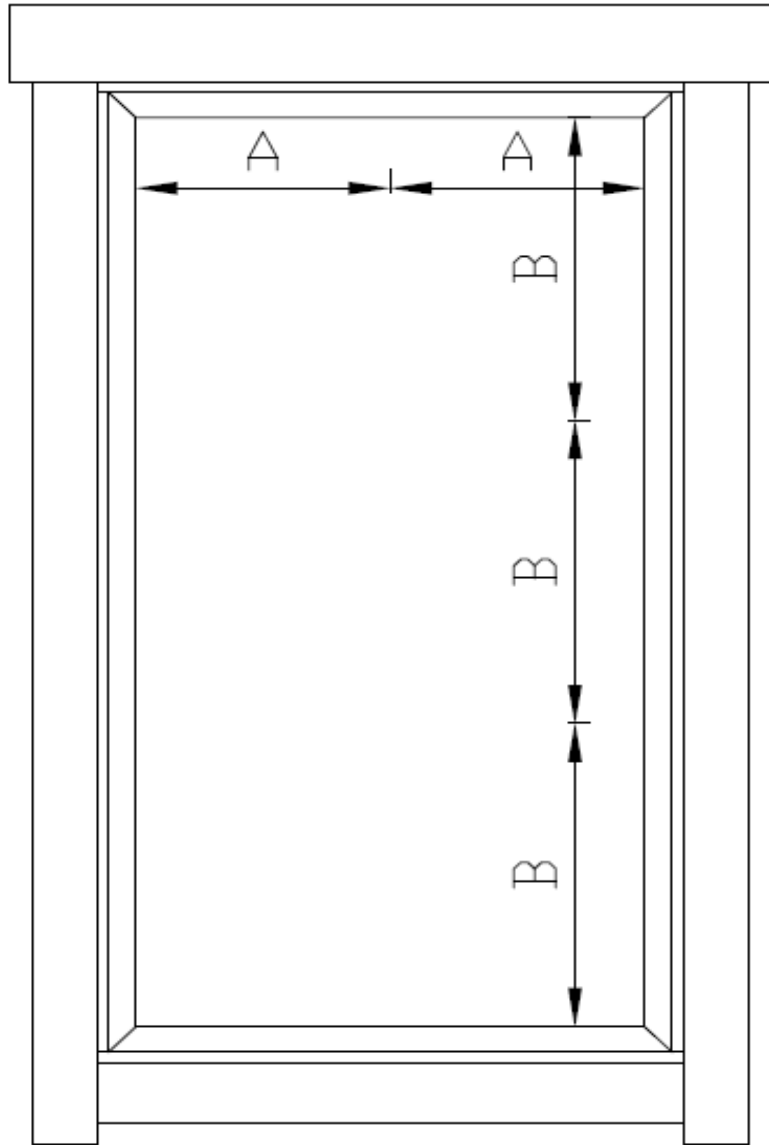
B=B

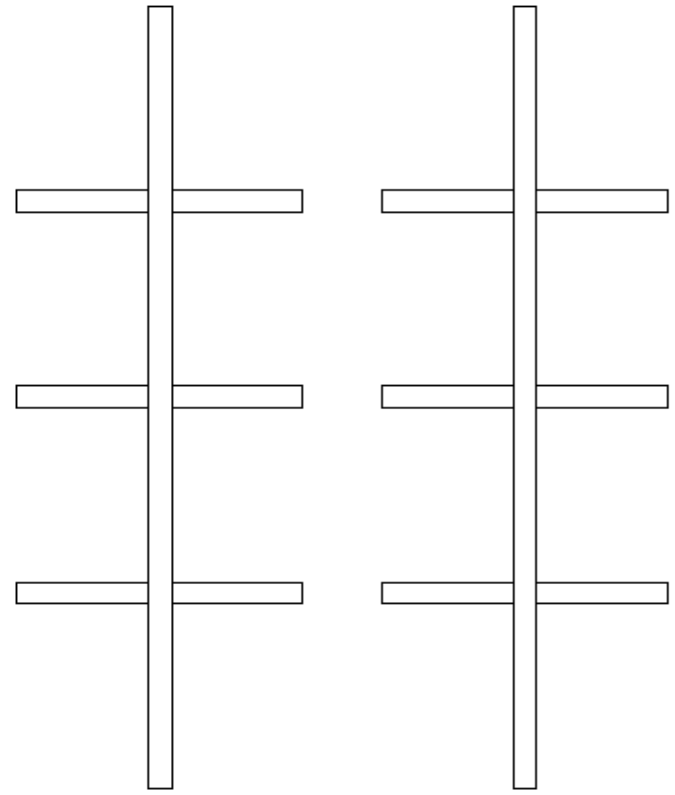
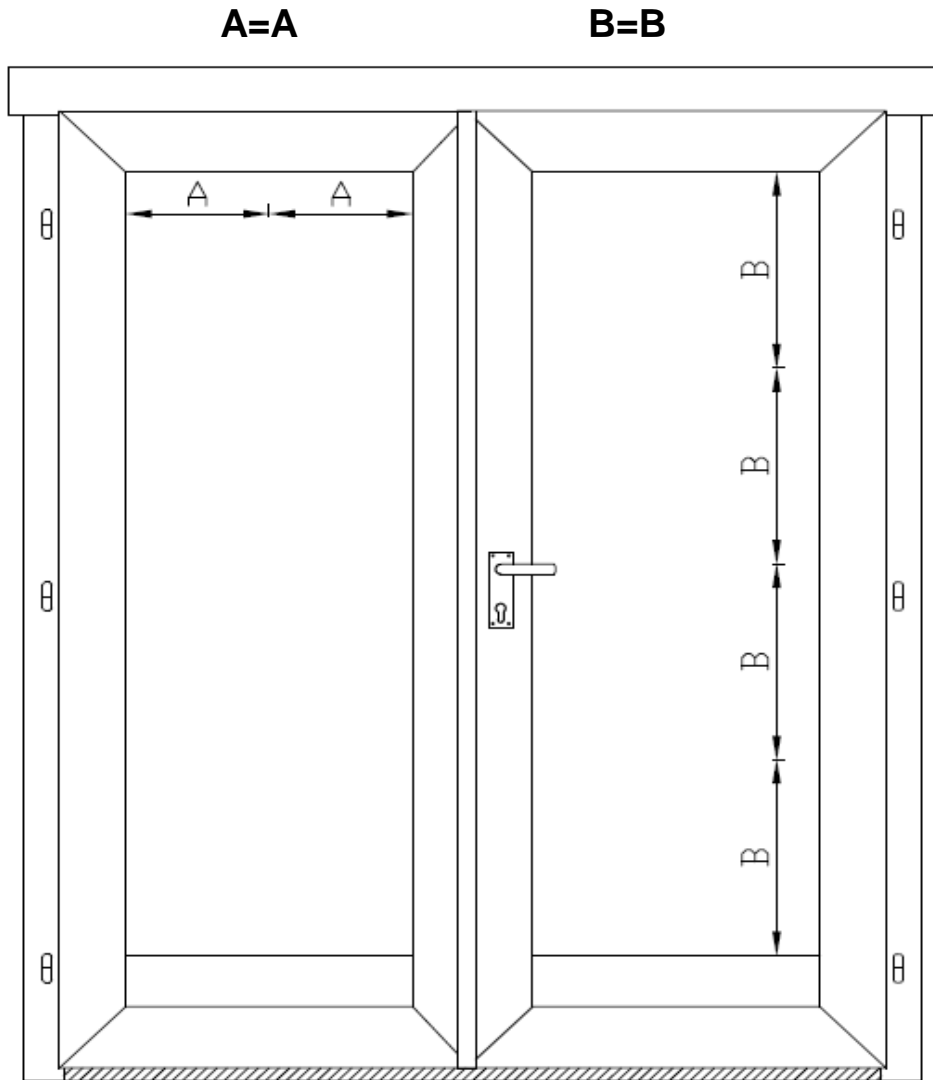



- | | |
|---|---------|
|  | - 16pcs |
|  | - 16pcs |
|  | - 32pcs |