

Nils
Art. Nr. 406300
1/6

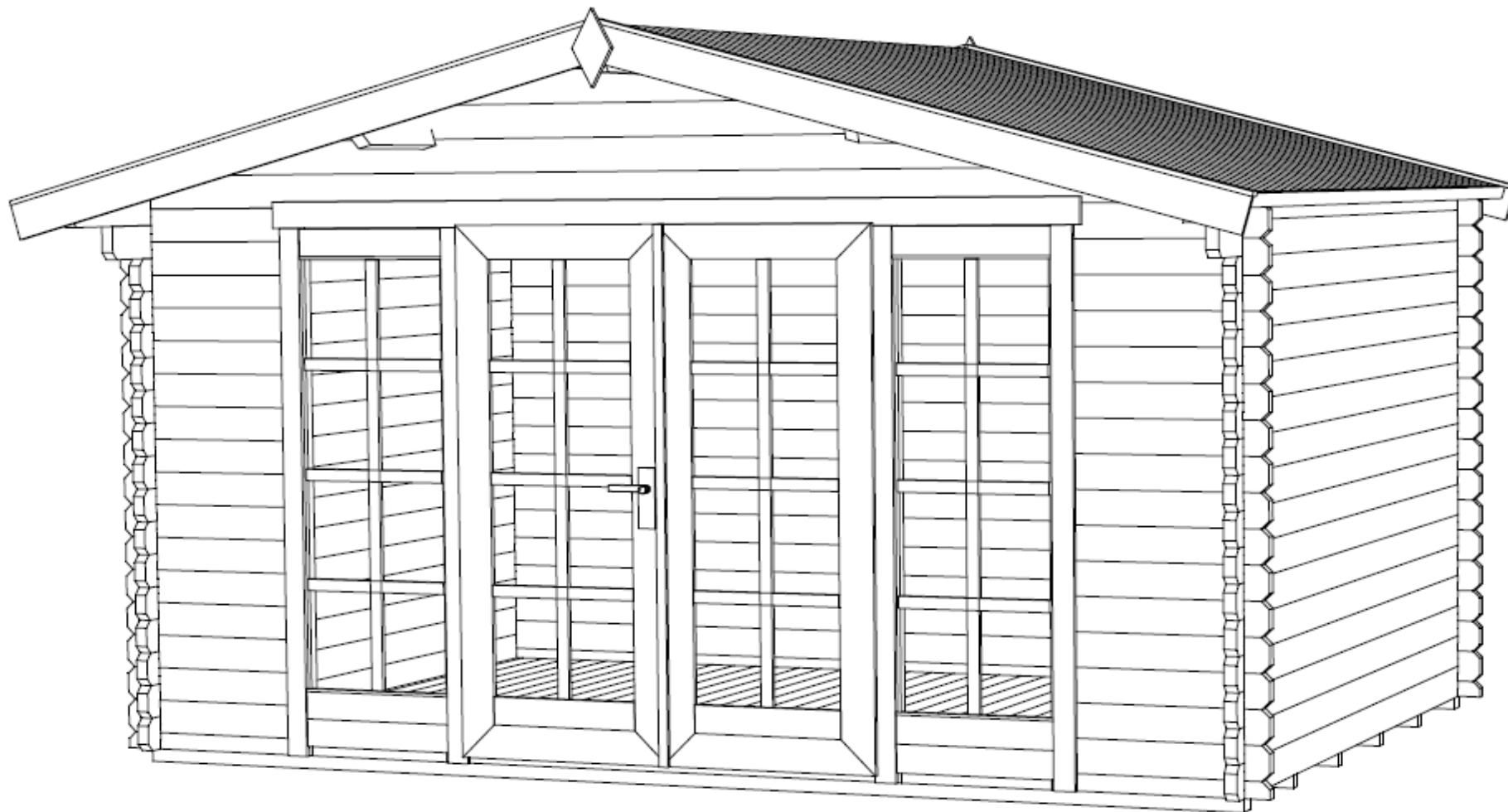

13.11.2013

GROUNDPLAN - GRUNDPLAN - PLAN DE MASSE

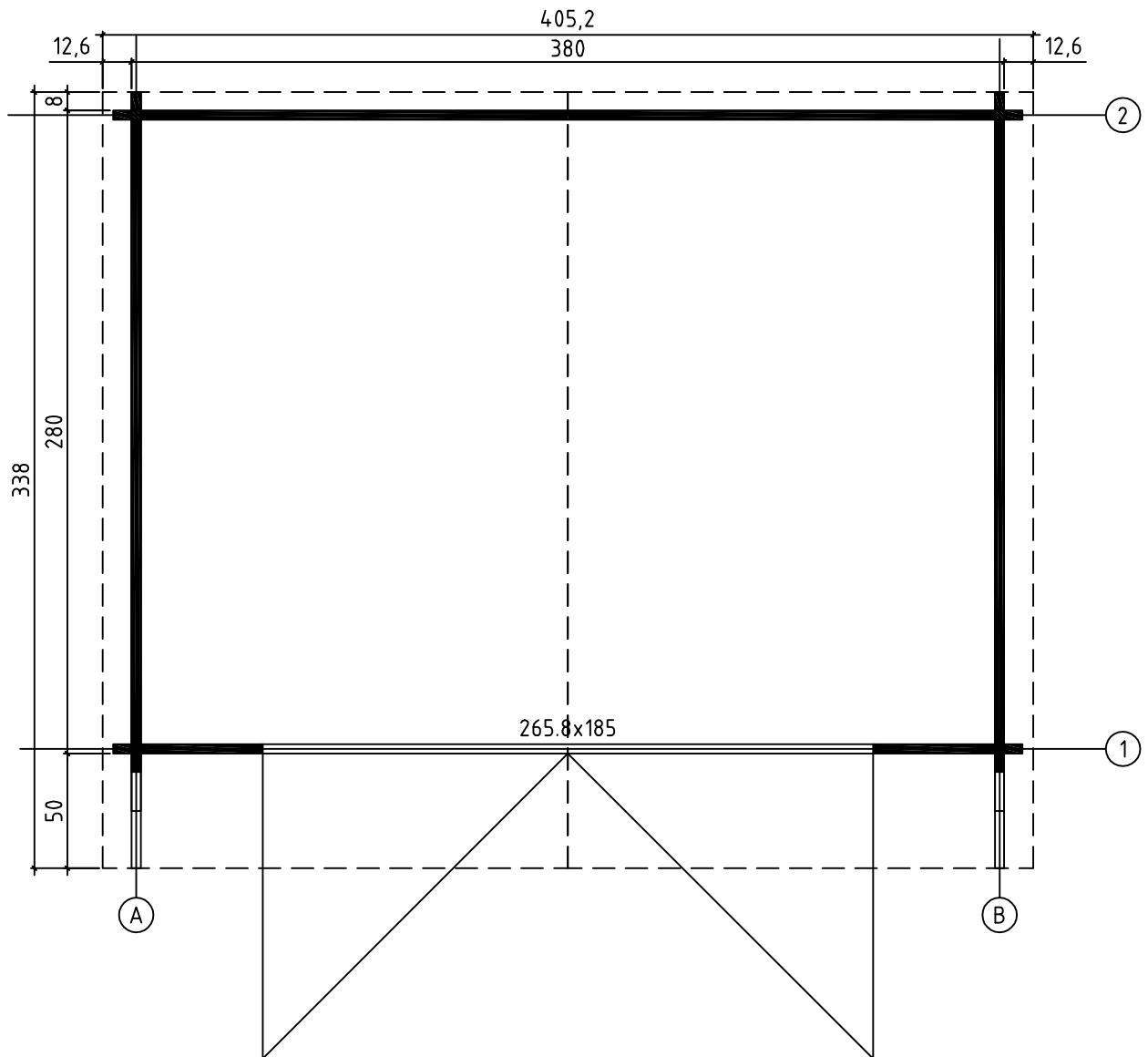

Art.Nr. 406300



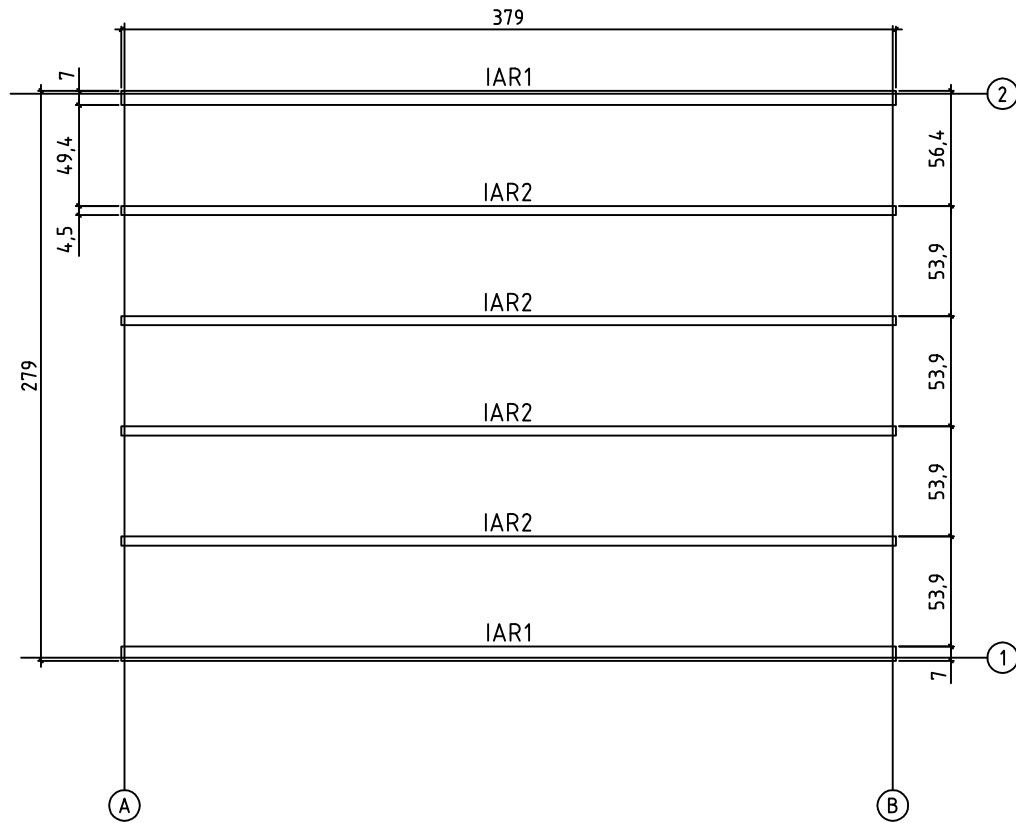



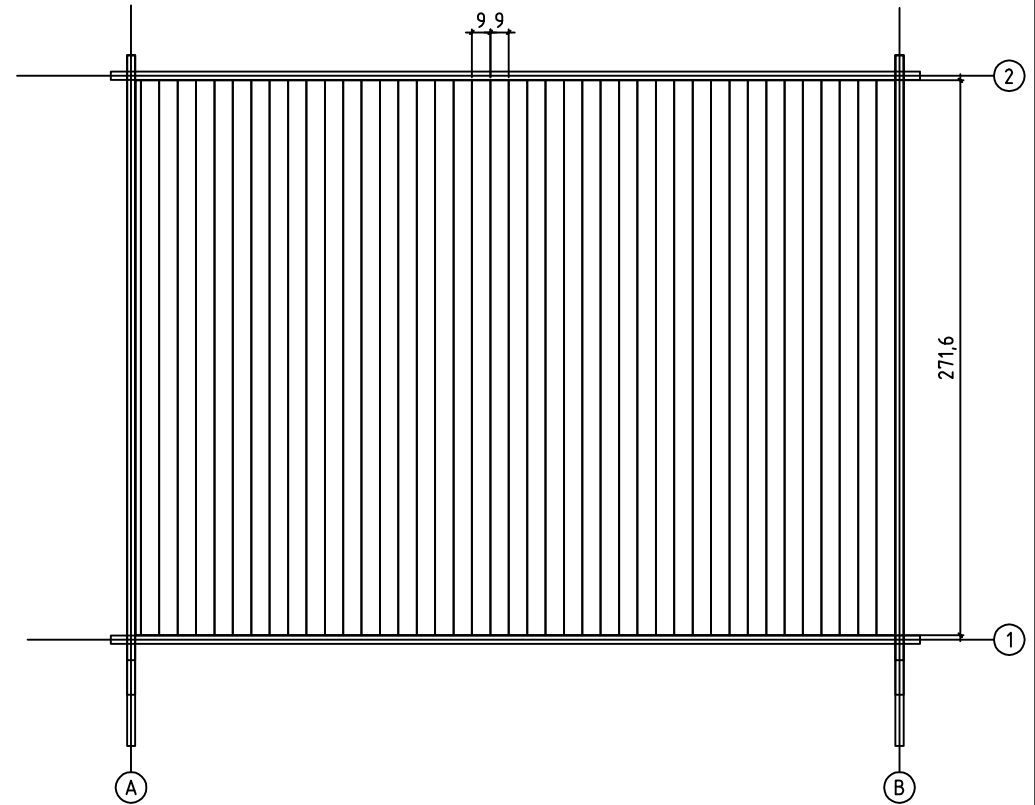

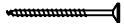
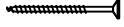
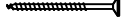

FOUNDATION - FUNDAMENT - FONDATION

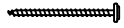

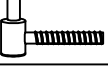
FLOOR BOARDS - FUSSBODENBRETTER -
PLAN POSE PLANCHER

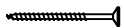

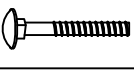
Pos	13.11.2013	Piecelist - Stücklist - Liste des composants Art.Nr. 4.06300	5/6	Q.	P. (mm)	L. (mm)
001				2	40x57	646
002				32	40x114	646
008				1	40x57	3960
009				16	40x114	3960
010				30	40x114	2960
011				2	40x114	3130
012				1	40x120	3380
013				1	40x120	3380
W1-1 W2-1				1 1		
IAR1		FOUNDATION - FUNDAMENT - FONDATION		2	70x45	3790
IAR2		FOUNDATION - FUNDAMENT - FONDATION		4	45x45	3790
PR1		ROOF BEAM - DACHBALKEN - PANNE DE TOIT		1	44x140	3380
A-PR1		ROOF BEAM - DACHBALKEN - PANNE DE TOIT		2	44x140	3380
	FLOOR BOARDS - FUSSBODENBRETTER - LAME DE PLANCHER			42	90x18	2716
	ROOF BOARDS - DACHBRETTER - VOLIGES			76	90x15	2100
	FLOOR FILLET - FUSSBODENLEISTE - CORNIERE DE FINITION DU PLANCHER				18x18	12.86
	ROOFING FELT FILLET - DACHPAPPENLEISTE - BAGUETTE DE FIXATION DU FEUTRE BITUMEUX			4	15x45	2150
	EAVES BOARD - TRAUFBRETT - BANDEAU DE TOIT			2	15x45	3380
	STORM PROTECTION - STURMLEISTE - - LATTE ANTI-TEMPETE			4	22x45	1880
	GABLE MOULDING - GIEBELLEISTE - - PLANCHE DE RIVE			4	15x120	2150
	ZN NAIL FOR FLOOR FILLET - ZN NÄGEL FÜR FUSSBODENLEISTE - - POINTE POUR CORNIERE DE FINITION DU PLANCHER			26	1.4x40	
	SCREW FOR GABLE SEGMENT - SCHRAUBEN FÜR DECKBLATT - - VIS POUR FIXATION LOSANGE DE FINITION			4	3.5x35	
HS4	SCREW FOR THE DOOR FRAME - SCHRAUBEN FÜR TÜRSTERZARGE - - VIS D'ASSEMBLAGE DU CADRE DE PORTE			14	3.5x35	
	SCREW FOR FILLET - SCHRAUBE ZUR BEFESTIGUNG TÜRLEISTE - - VIS D'ASSEMBLAGE DU CADRE DE PORTE			5	3x30	

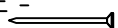
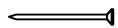
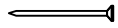
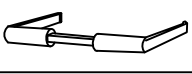
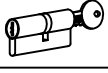
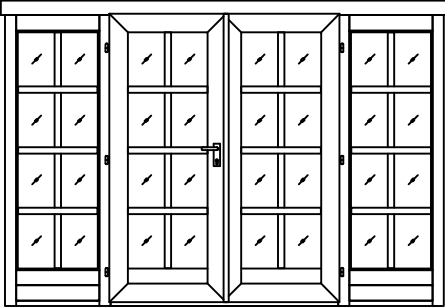
Pos	13.11.2013	Piecelist - Stücklist - Liste des composants Art.Nr. 406300	6/6	Q.	P. (mm)	L. (mm)
		SCREW FOR ROOF BEAMS - SCHRAUBEN FÜR DACHBALKEN - - VIS POUR PANNE DE TOIT		10	5x120	
		SCREW FOR 1. WALL BEAM - SCHRAUBE FÜR 1. BOHLENREIHE - - VIS DE FIXATION DES FONDATIONS		7	5x90	
HS1		SCREW FOR DOOR JAMB - SCHRAUBE FÜR TÜRRAHMEN - VIS DE FIXATION POUR MONTANT DE PORTE		4	5x90	
		DOOR HANDLE FITTINGS - TÜRGRIFF - SET DE GARNITURES DE SERRURE DE PORTE		1		
		HAMMER BLOCK - SCHLAGHOLZ - CALLE DE FRAPPE40mm		1		
		SCREW FOR DOORSTEP - SCHRAUBEN FÜR SWELLE - VIS DE FIXATION DU SEUIL DE PORTE		3	4.5x65	
		NAILS FOR WINDOW/DOOR CROSS SLOT STRAIGHT - NÄGEL FÜR FENSTER/TÜREN EINSENWAREN - POINTE POUR QUINCAILLERIE DE PORTES ET FENETRES		64	1.4x30	
		WINDOW/DOOR CROSS SLOT STRAIGHT (PLASTIC) - FENSTER/TÜREN EINSENWAREN - POINTE POUR QUINCAILLERIE DE PORTES ET FENETRES		32		
		MALE BOLT HINGE FOR DOOR - TÜRRIEGEL - PARTIE MALE DE CHARNIERE DE PORTE		6		
		SCREW FOR GABLE MOULDING - SCHRAUBEN FÜR GIEBELLEISTE - - VIS DE FIXATION POUR PLANCHE DE RIVE		24	3.5x50	
		SCREW FOR EAVES BOARDS - SCHRAUBEN FÜR TRAUFBRETTEN - - VIS DE FIXATION POUR BANDEAU DE TOIT		16	4x40	
		GABLE SEGMENT - DECKBLATT - LOSANGE DE FINITION		2		
		NUT FOR STORM PROTECTION - SCHRAUBENMUTTER FÜR STURMLEISTE - - ÉCROU POUR LAME ANTI-TEMPETE		8	D6	
		BOLT FOR STORM PROTECTION - BOLZEN FÜR STURMLEISTE - - VIS POUR LAME ANTI-TEMPETE		8	8x70	
		WASHER FOR STORM PROTECTION - DICHTSCHEIBE FÜR STURMLEISTE - - RONDELLE POUR LAME ANTI-TEMPETE		8	D6	
		ZN NAIL FOR ROOFING FELT FILLET - ZN NÄGEL FÜR DACHPAPPENLEISTE - - POINTE POUR BAGUETTE FIXATION FEUTRE BITUMEUX		20	2x40	
		ZN NAIL FOR ROOF - ZN NÄGEL FÜR DACHBRETTEN - POINTE POUR TOIT		242	2x50	
		ZN NAIL FOR FLOOR - ZN NÄGEL FÜR FUSSBODENBRETTEN - - CLOUS POUR PLANCHER		258	2x50	
		DOOR HANDLE FITTINGS - TÜRGRIFF - GARNITURE DE POIGNÉE DE PORTE		1		
		CYLINDER - ZYLINDERSCHLOSS - CYLINDRE DE SERRURE		1	30x35	
		DOOR - TÜR - PORTE 2658x1850 SGC		3UK.1.108.SVV.MPb	1	

Art.Nr. 406300

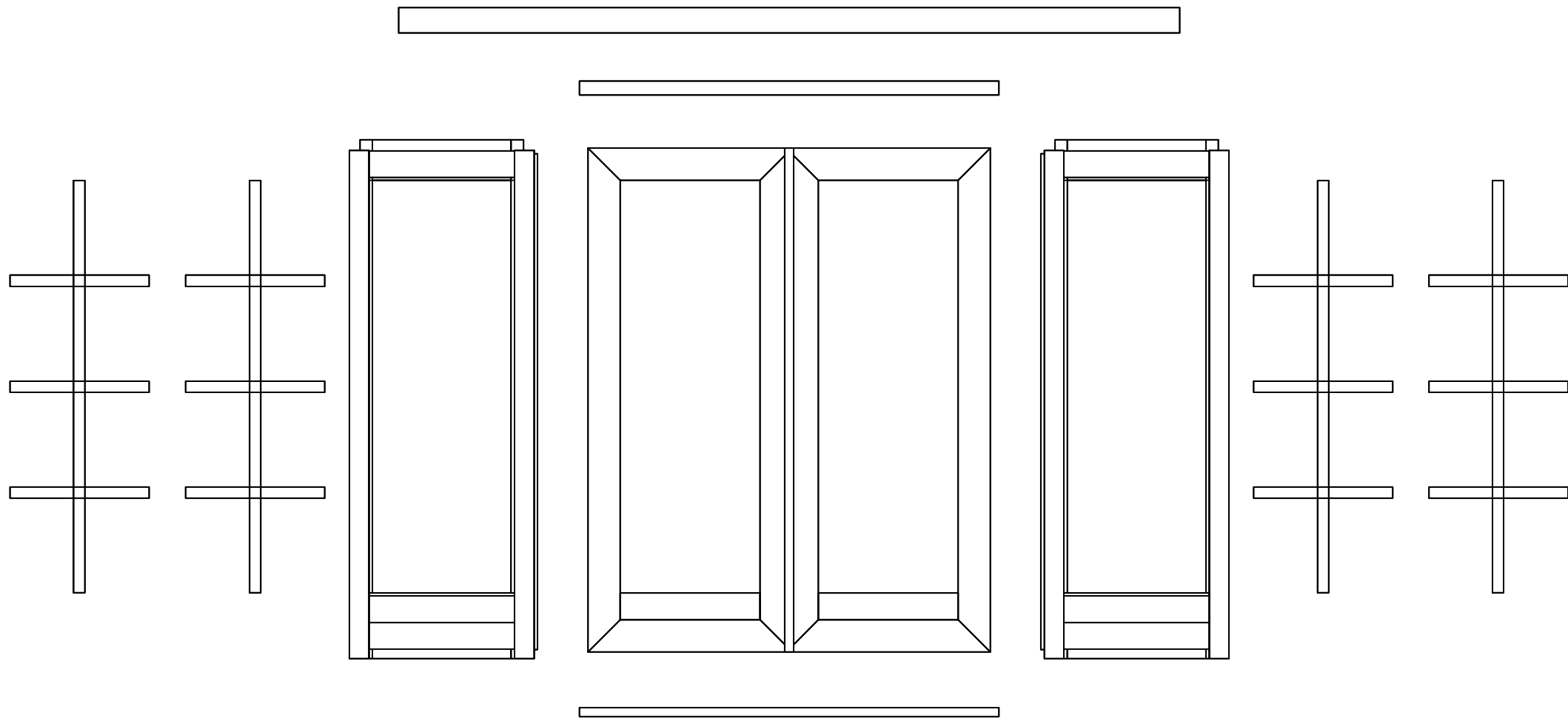

Art.Nr. 406300

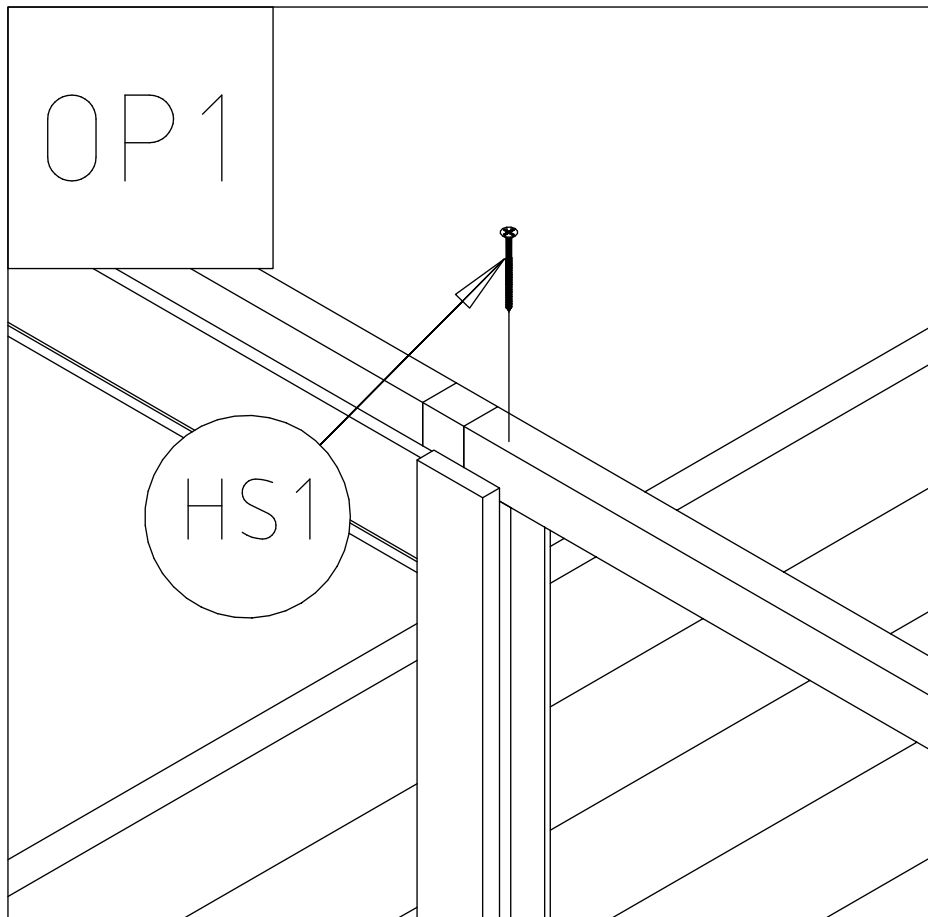
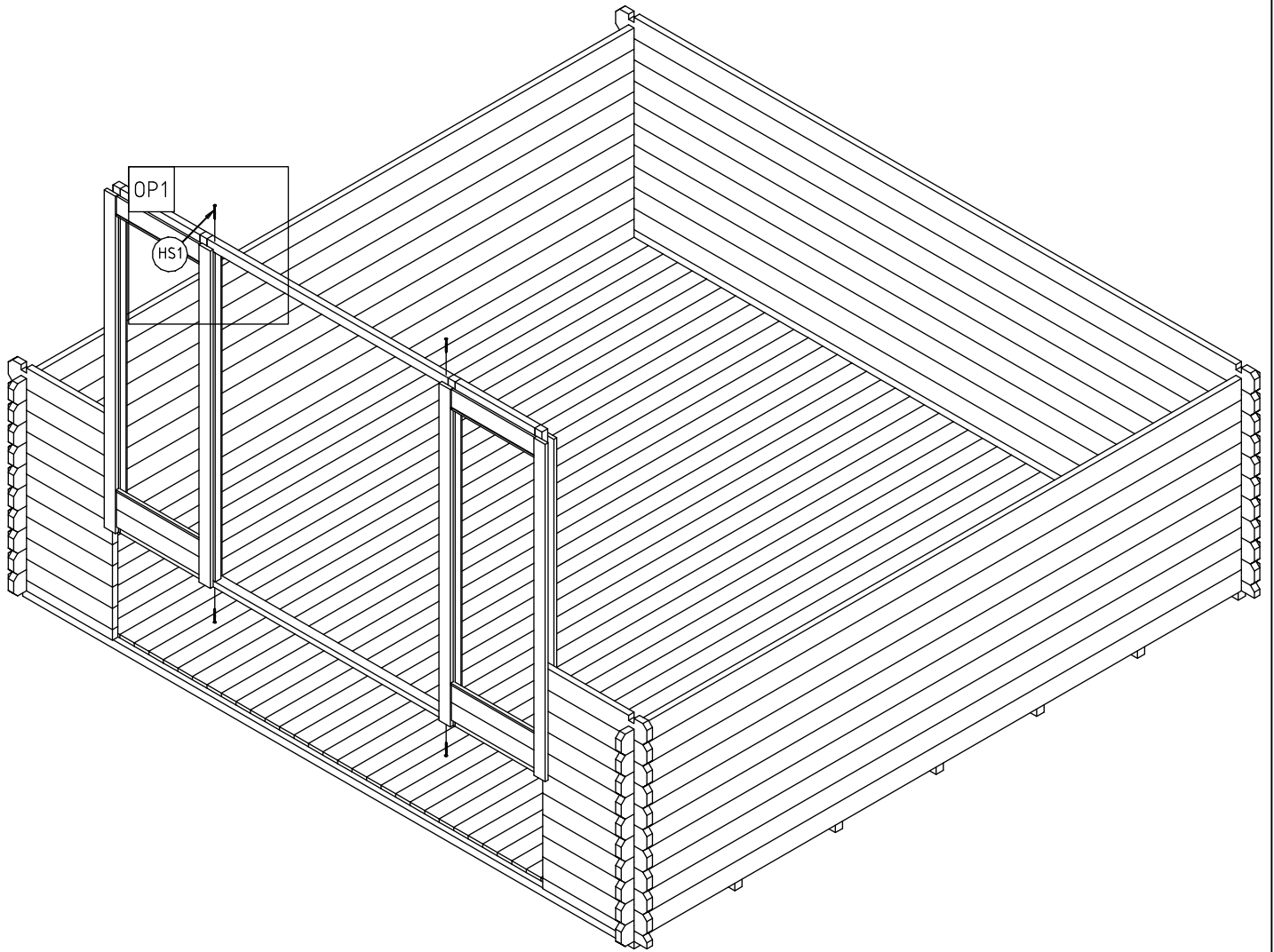

Art.Nr. 406300

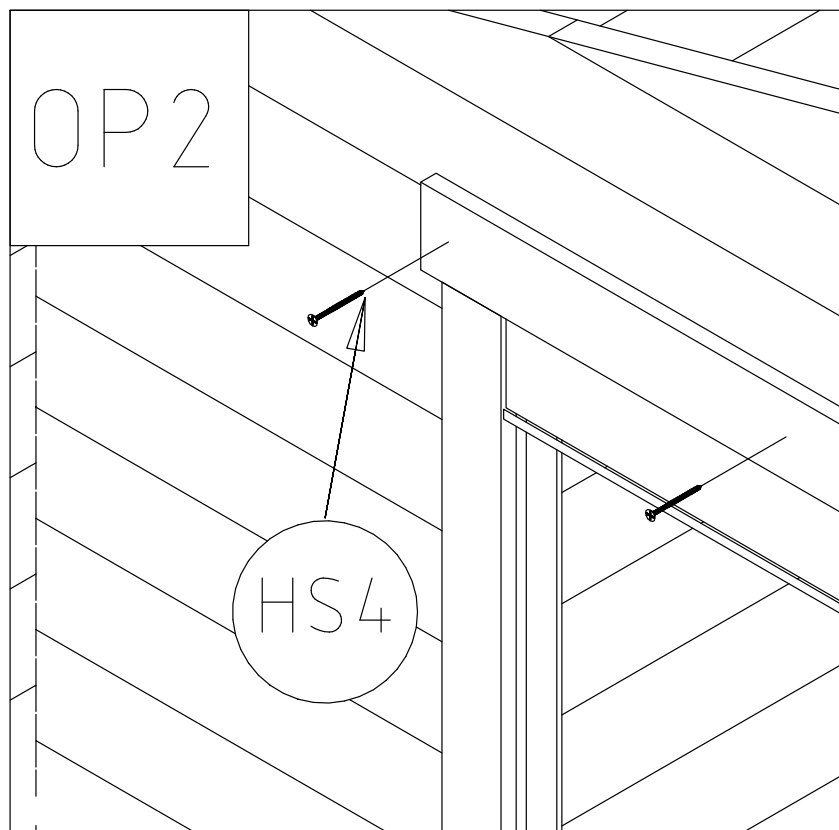
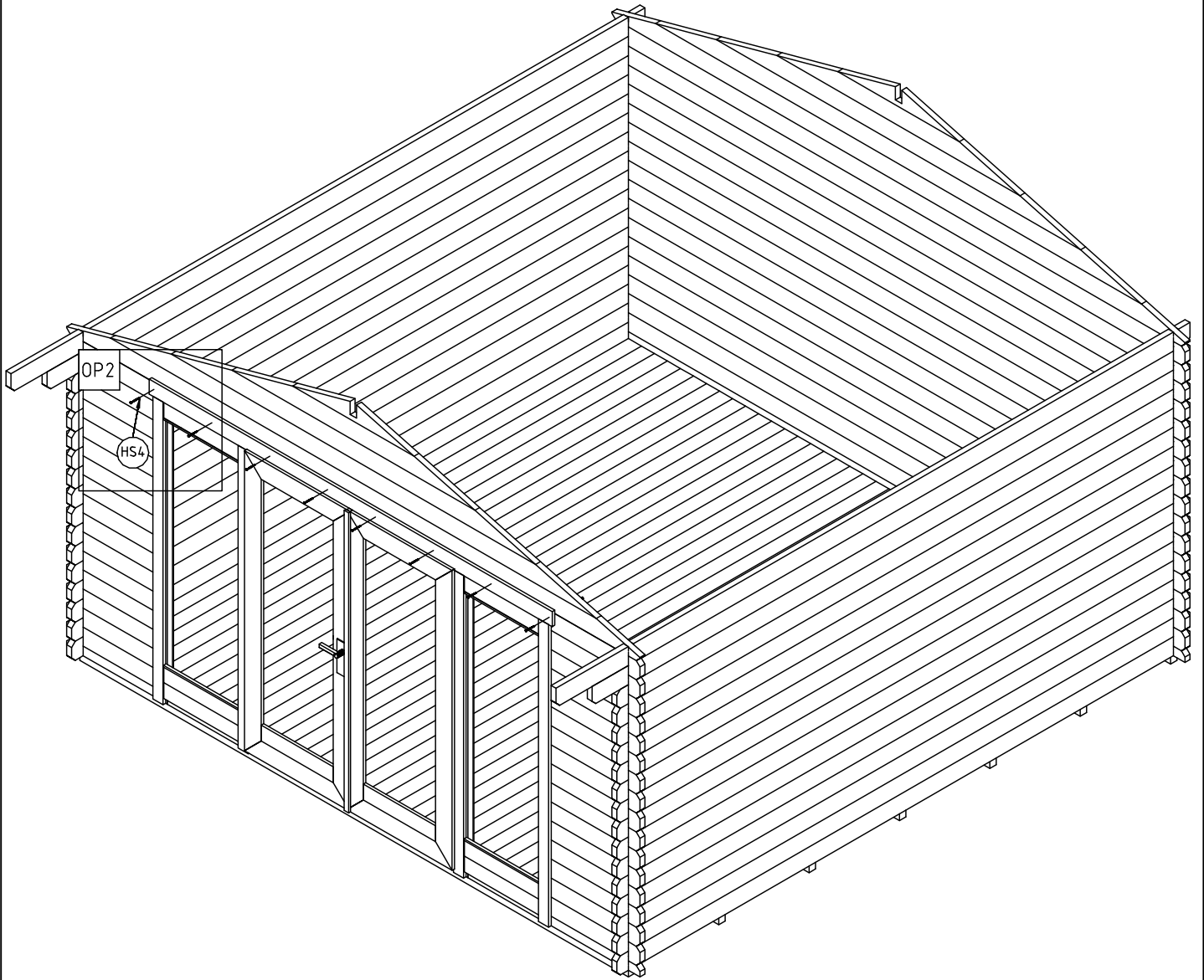

Art.Nr. 406300

