

Art. Nr. 4011150

1/8

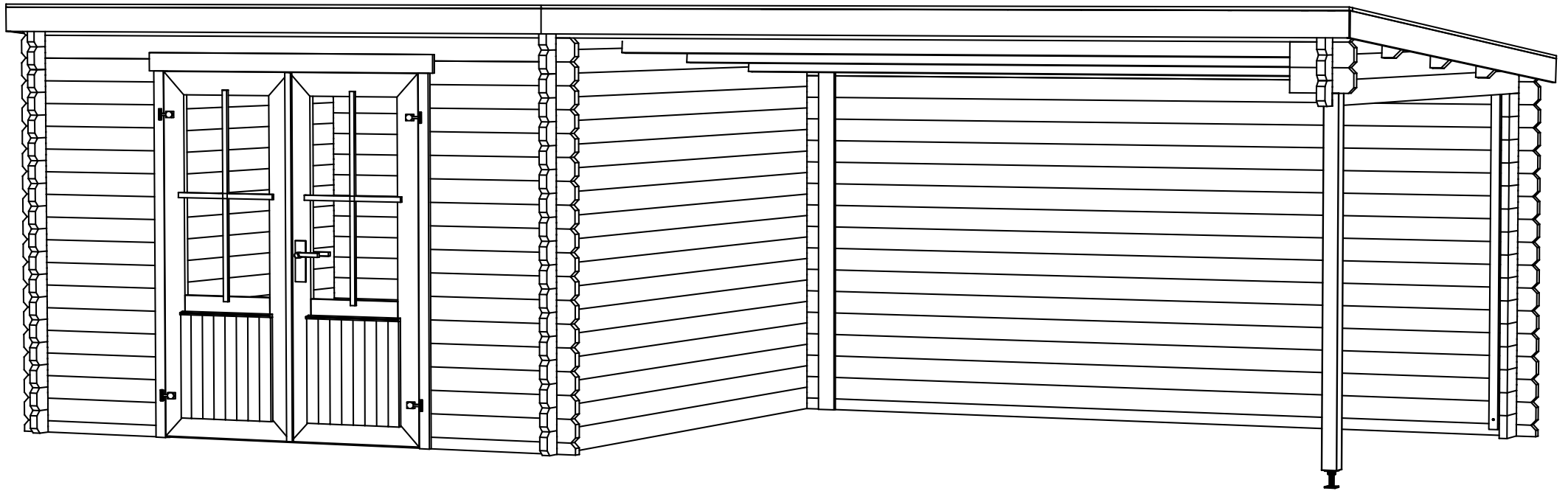







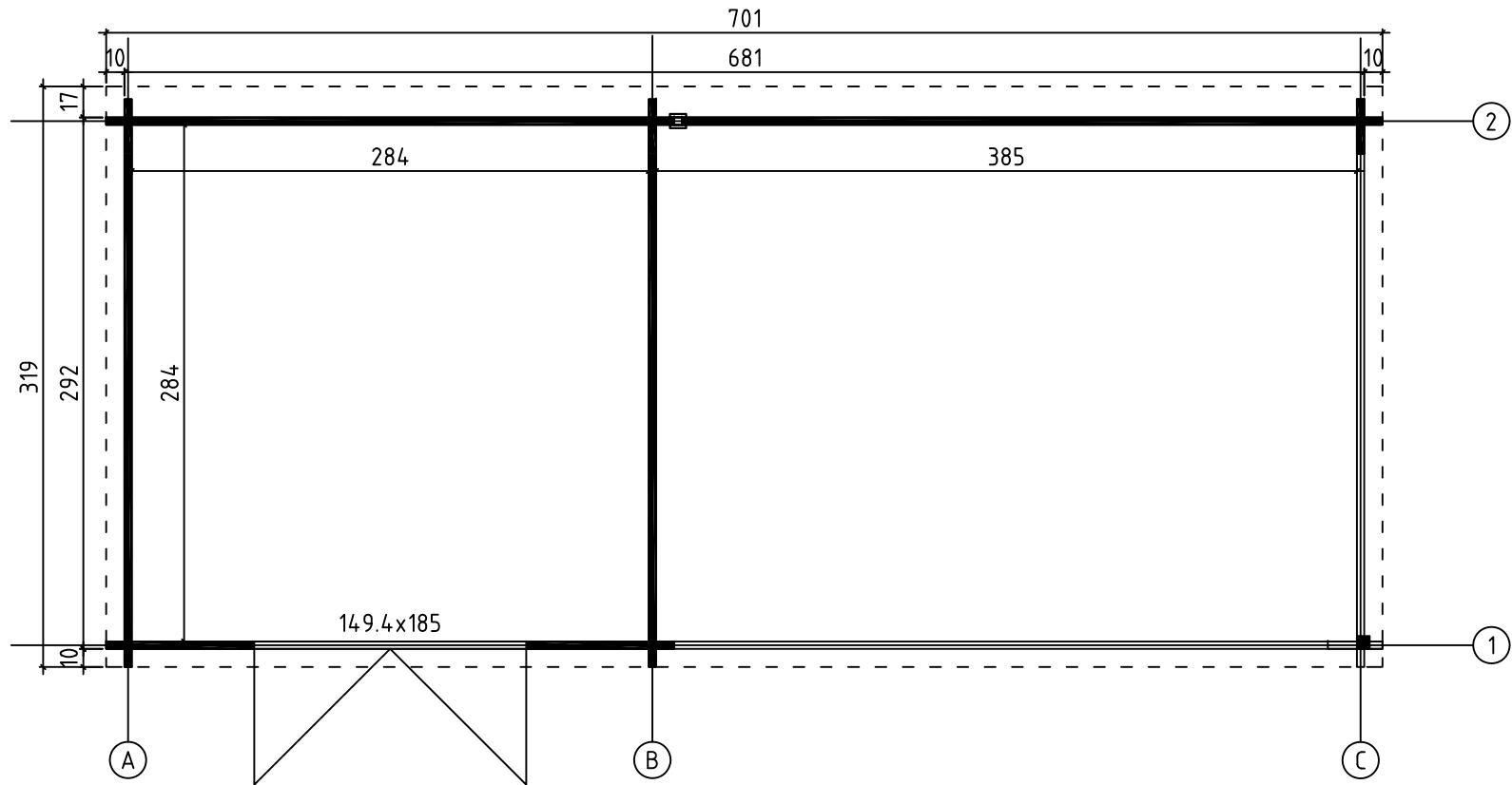

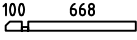
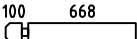
25.08.2015

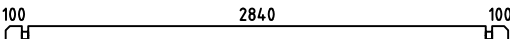
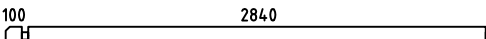
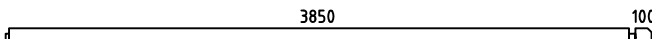
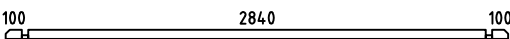
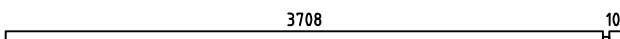
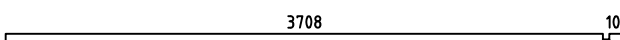
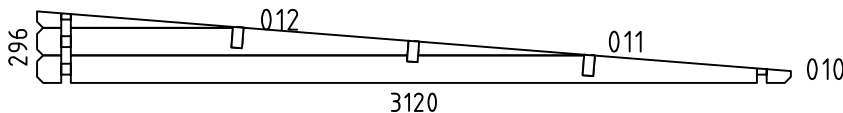
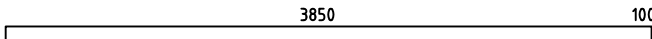
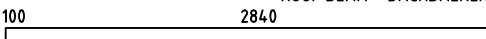
Art.nr. 4011150

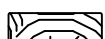
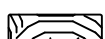
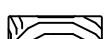

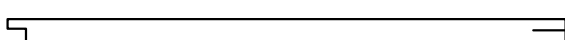
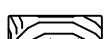
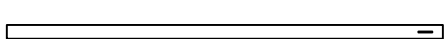

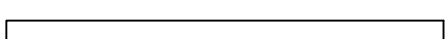
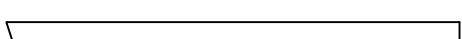
GROUNDPLAN - GRUNDPLAN - PLAN DE MASSE

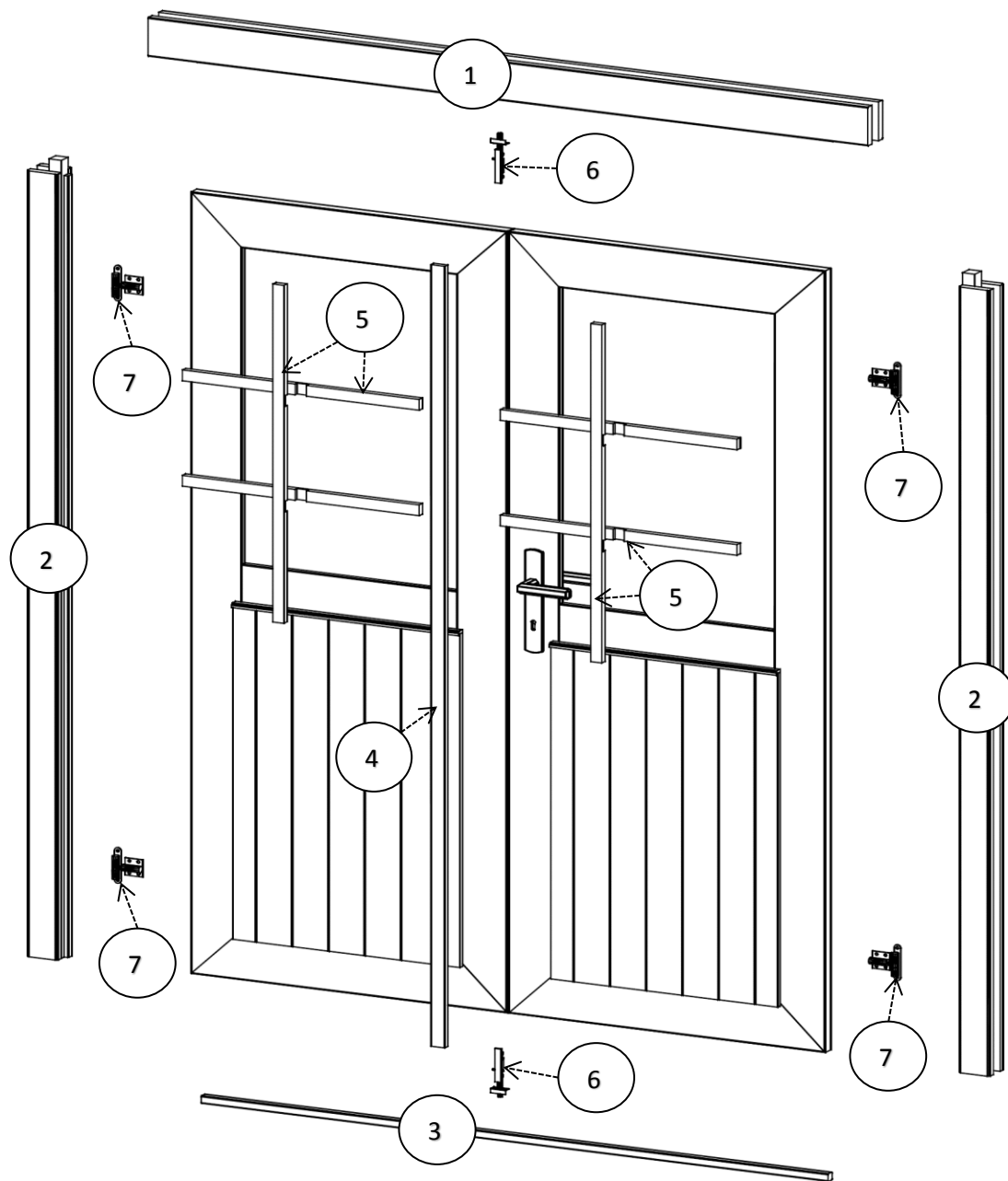

Pos	25.08.2015	Piece list - Stückliste - Liste des pièces Art.nr. 4011150	5/7	Q.	P (mm)	L (mm)
001				2	40x57	808
002				32	40x114	808
003				17	40x114	300
004				49	40x114	3120
005				2	40x114	3000
006				2	40x114	4010
007				1	40x57	3120
008				1	40x57	3848
009				15	40x114	3848
WA-1 WB-1 WC-1				1 1 1		
A-PR2		ROOF BEAM - DACHBALKEN - PANNE DE TOIT 3850		3	44x140	4010
A-PR1		ROOF BEAM - DACHBALKEN - PANNE DE TOIT 2840		3	44x140	3000
DB	ROOF BOARDS - DACHBRETTER - VOLIGES			78	90x15	3200
	H-PROFILE - WANDVERBINDUNG - PROFILE H			1	72x90	1820
DPL1	ROOFING FELT FILLET - DACHPAPPENLEISTE - BAGUETTE DE FIXATION DU FEUTRE BITUMEUX			1	15x45	3015
DPL2	ROOFING FELT FILLET - DACHPAPPENLEISTE - BAGUETTE DE FIXATION DU FEUTRE BITUMEUX			2	15x45	3220
DPL3	ROOFING FELT FILLET - DACHPAPPENLEISTE - BAGUETTE DE FIXATION DU FEUTRE BITUMEUX			1	15x45	4025
DPP	ROOFING FELT (STRIP) - DACHPAPPE (BAHNEN) - FEUTRE BITUMEUX (BANDE)			4		7110
P	POST - PFOSTEN - POTEAU			1	70x70	1687
DRV	ROOF EDGE REINFORCEMENT - DACHRANDVERSTÄRKUNG - CORNIERE DE RENFORT DE BORD DE TOIT			2	15x45	3505
KFS	STORM PROTECTION - STURMLEISTE - LATTE ANTI-TEMPETE			3	22x45	1800
KFS	STORM PROTECTION - STURMLEISTE - LATTE ANTI-TEMPETE			2	22x45	2000
GL1	GABLE MOULDING - GIEBELLEISTE - PLANCHE DE RIVE			1	15x120	3015
GL2	GABLE MOULDING - GIEBELLEISTE - PLANCHE DE RIVE			2	15x120	3250

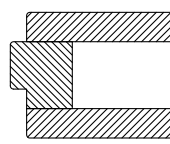
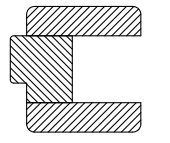
Pos	25.08.2015	Piece list - Stückliste - Liste des pièces Art.nr. 4011150	6/7	Q.	P (mm)	L (mm)
GL3	GABLE MOULDING - GIEBELLEISTE - PLANCHE DE RIVE			1	15x120	4025
	SCREW FOR GEORGIAN BARS - SCHRAUBE FÜR SPROSSEN - VIS DE BARRES GEORGIENNE			8	2.5x20	
	SCREW FOR POST - SCHRAUBEN FÜR PFOSTEN - VIS DE FIXATION DES POTEAUX			2	3.5x50	
HS22	SCREW FOR FIXING DOOR TO THE WALL - SCHRAUBE ZUR BEFESTIGUNG TÜR - ZARGE MIT WAND - VIS POUR FIXATION DORMANT DE PORTE AU 1ER RANG DE MADRIER			2	3.5x50	
HS16	SCREW FOR GABLE MOULDING - SCHRAUBEN FÜR GIEBELLEISTE - VIS POUR FIXATION PLANCHE DE RIVE			38	3.5x50	
HS59	SCREW FOR DOORSTEP - SCHRAUBEN FÜR SWELLE - VIS POUR FIXATION BARRE DE SEUIL			3	3x30	
	SCREW FOR ROOF EDGE REINFORCEMENT - SCHRAUBEN FÜR DACHRANDVERSTÄRKUNG - VIS POUR FIXATION CORNIERE RENFORT DE BORD DE TOIT			16	3x30	
HS3	SCREW FOR DOOR FILLET - SCHRAUBE ZUR BEFESTIGUNG TÜRLEISTE - VIS POUR FIXATION BAGUETTE D'ARRET DE PORTE			5	3x30	
HS56	SCREW FOR FIXING BOLT HINGE - SCHRAUBE FÜR TÜRRIGEL - VIS POUR FIXATION GONDS DE PORTE - POUR OUVRANT			16	4x30	
HS58	SCREW FOR FIXING BOLT HINGE - SCHRAUBE FÜR TÜRRIGEL - VIS POUR FIXATION GONDS DE PORTE - POUR OUVRANT			12	4x40	
HS99	SCREWS FOR WALL MOUNTING - SCHRAUBEN FÜR WANDMONTAGE - VIS DE FIXATION AU MUR			1	4.5x80	
HS41	SCREW FOR DOOR JAMB - SCHRAUBE FÜR TÜRRAHMEN - VIS POUR FIXATION MONTANT DE PORTE			2	4x60	
HS43	SCREW FOR ROOF BEAMS - SCHRAUBEN FÜR DACHBALKEN - VIS POUR FIXATION PANNES DE TOIT			20	5x120	
HS41	SCREW FOR DOOR JAMB - SCHRAUBE FÜR TÜRRAHMEN - VIS POUR FIXATION MONTANT DE PORTE			2	5x90	
	SCREW FOR POST HEIGHT ADJUSTMENT - SCHRAUBEN FÜR REGULIERUNGSSCHRAUBE FÜR PFOSTEN - VIS DE FIXATION DE SUPPORT RÉGLABLE DE POTEAU			8	6x50	
SH40	HAMMER BLOCK - SCHLAGHOLZ - CALLE DE FRAPPE			1		
SFS	NUT FOR STORM PROTECTION - SCHRAUBENMUTTER FÜR STURMLEISTE - ECROU POUR LATTE ANTI-TEMPETE			10	D6	
	NUT FOR POST HEIGHT ADJUSTMENT - MUTTER FÜR REGULIERUNGSSCHRAUBE - ECROU POUR SUPPORT RÉGLABLE DE POTEAU			1	D16	
NF2	ZN NAIL FOR ROOF - ZN NÄGEL FÜR DACHBRETTER - POINTE POUR FIXATION VOLIGES DE TOIT			418	2x50	
NFD	ZN NAIL FOR ROOFING FELT FILLET - ZN NÄGEL FÜR DACHPAPPENLEISTE - POINTE POUR BAGUETTE DE FIXATION FEUTRE BITUMEUX			32	2x40	
NF	ROOFING NAILS FOR ROOFING FELT - NÄGEL FÜR DACHPAPPE - POINTE POUR FIXATION FEUTRE BITUMEUX			250	2.8x15	
	MALE BOLT HINGE FOR DOOR - TÜRRIEGEL - PARTIE MALE DE PAUMELLE DE PORTE			4		
BFS	BOLT FOR STORM PROTECTION - BOLZEN FÜR STURMLEISTE - BOULON POUR LATTE ANTI-TEMPETE			10	6x70	
TL	LATCH BOLT FOR DOUBLE DOOR - TORRIEGEL - LOQUET POUR DOUBLE PORTE			2		90
DFS	WASHER FOR STORM PROTECTION - DICHTSCHEIBE FÜR STURMLEISTE - RONDELLE POUR LATTE ANTI-TEMPETE			10	D6	

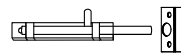
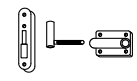

Pos	Piece list - Stückliste - Liste des pièces	Q.	P (mm)
1		1	77x100
2		2	77x80
3		1	18x29
4		1	13x32
5		6	15x25
6		2	
7		4	

