

Art. Nr. 2839496

1/16

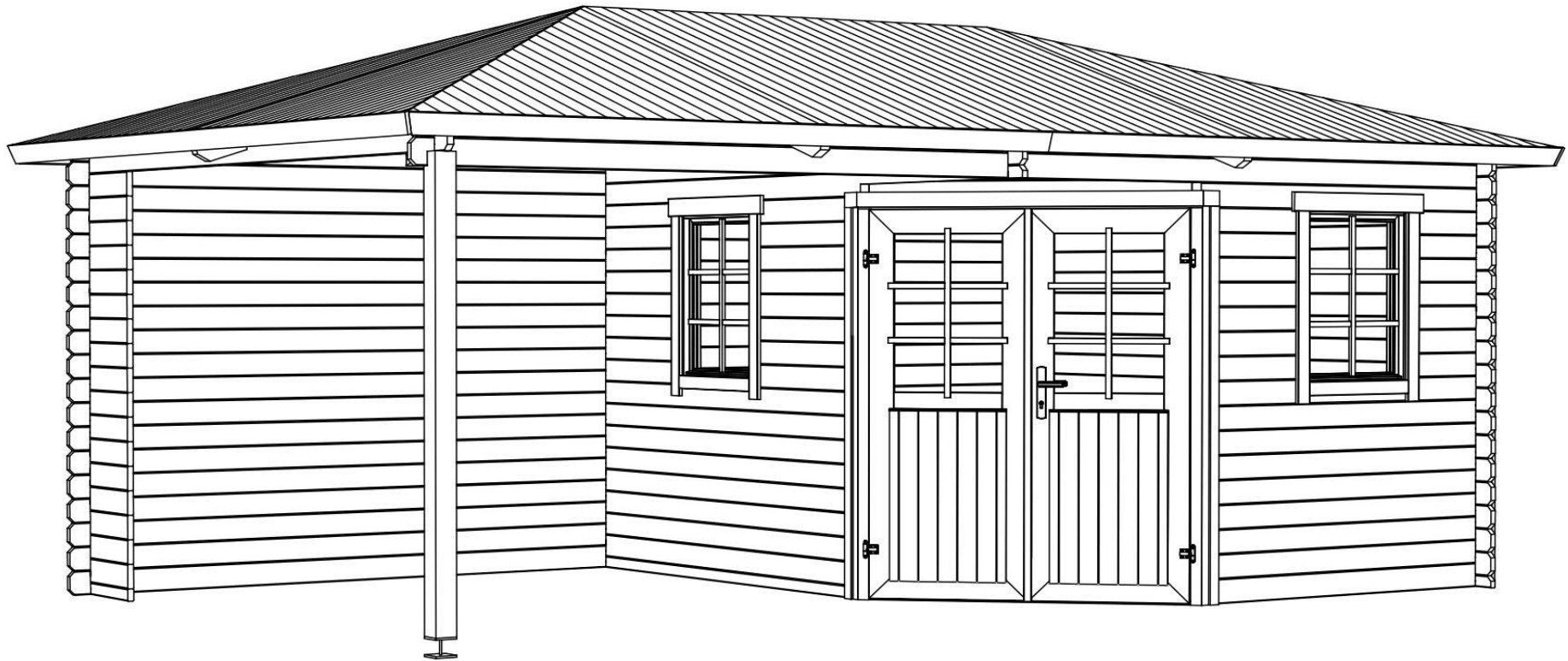

12.12.2017

Art. Nr. 2839496

Groundplan - Grundplan - Plan de masse - Planimetria -
Plattegrond - Põhiplaan

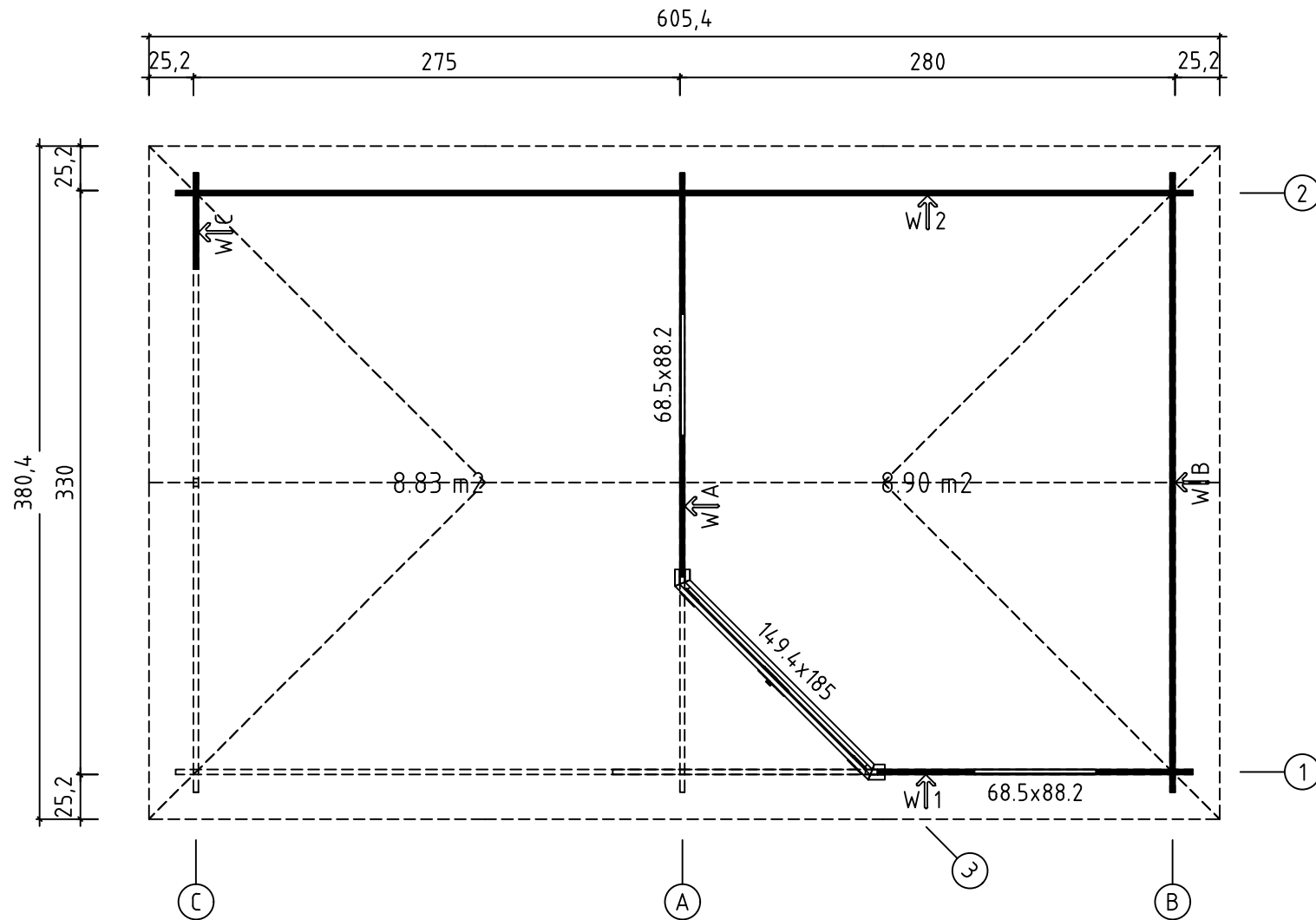

Art. Nr. 2839496

Overhead beams - Deckenbalken - Solives -
Travi a vista - Overlopende balken - Laetalade
konstruktsioon

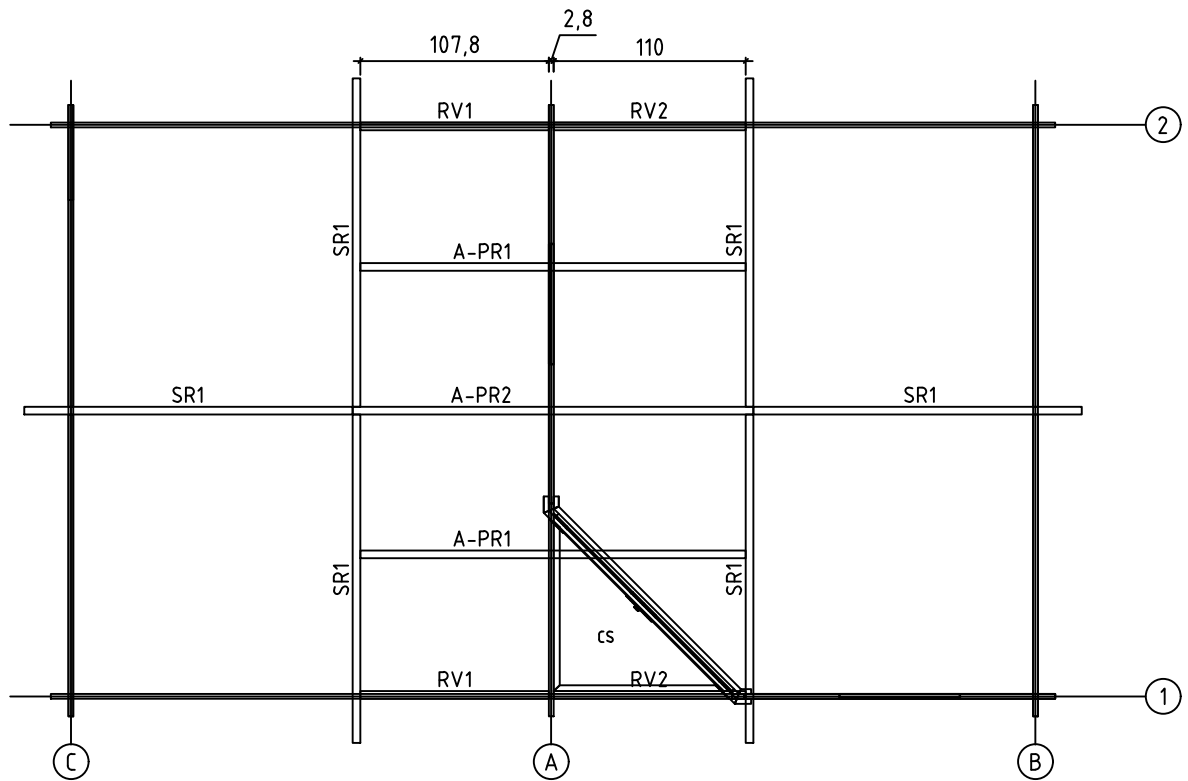

Diagonals must be equal - Prüfung diagonale
Austrichtung A=B - Controle des diagonales A=B
- Le diagonali devono essere eguali -
Gelijkbenige diagonaal - Diagonaalid peavad
olema võrdsed A=B

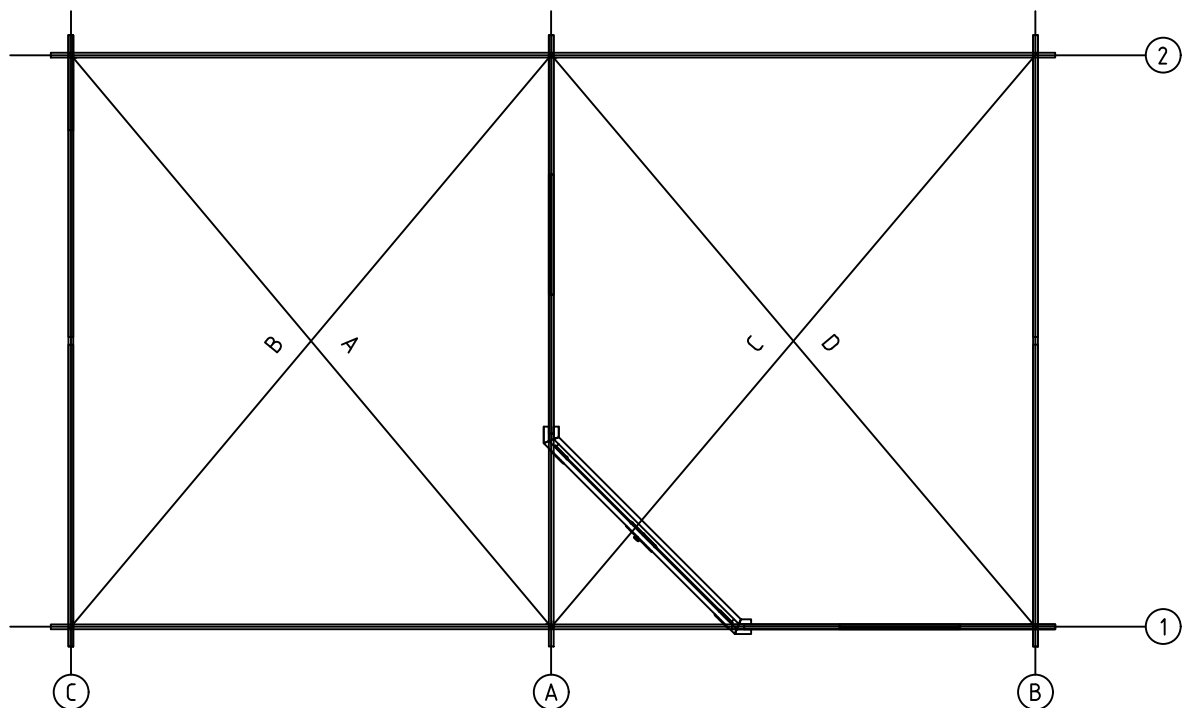

Art. Nr. 2839496

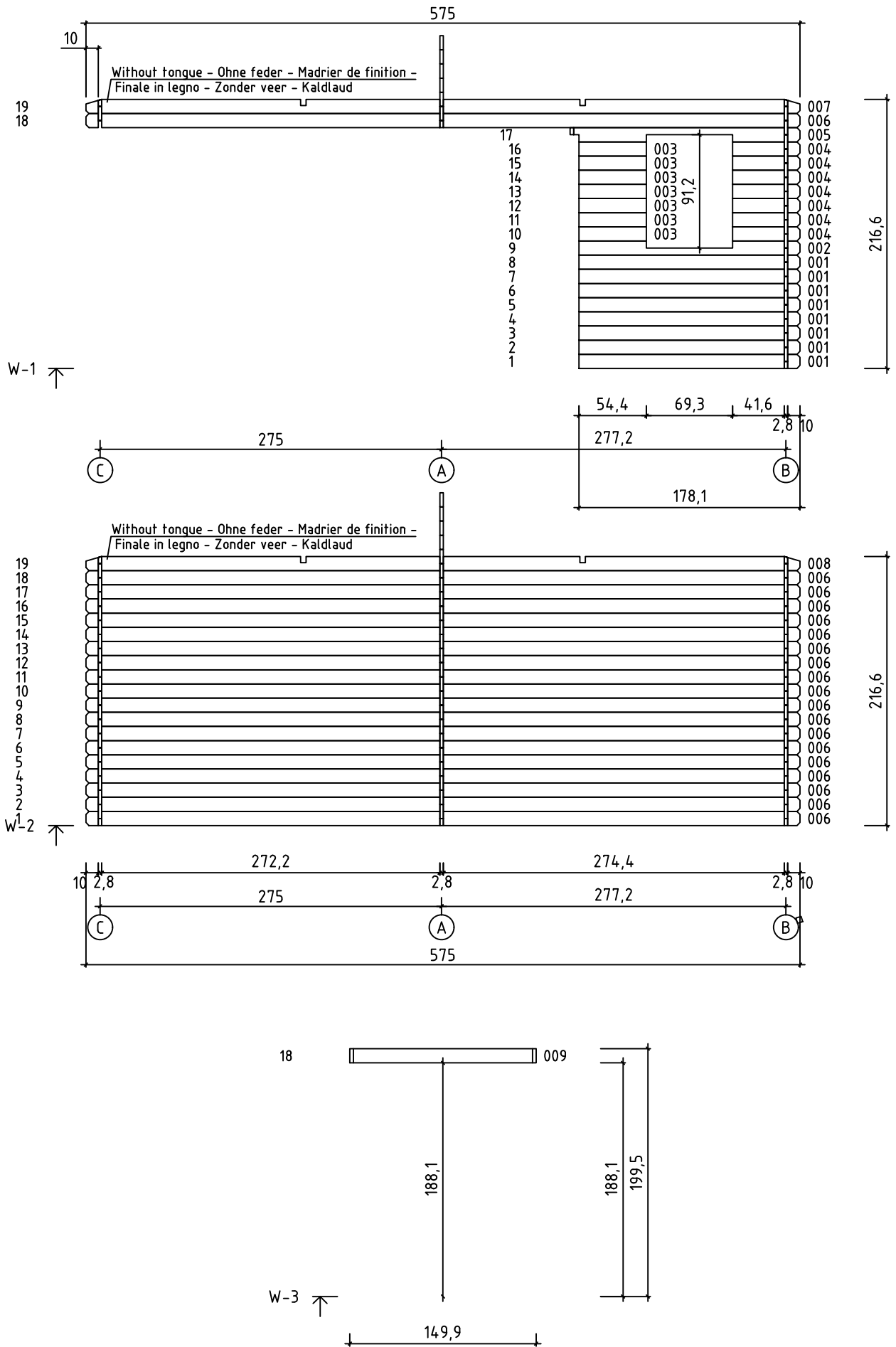

Art. Nr. 2839496

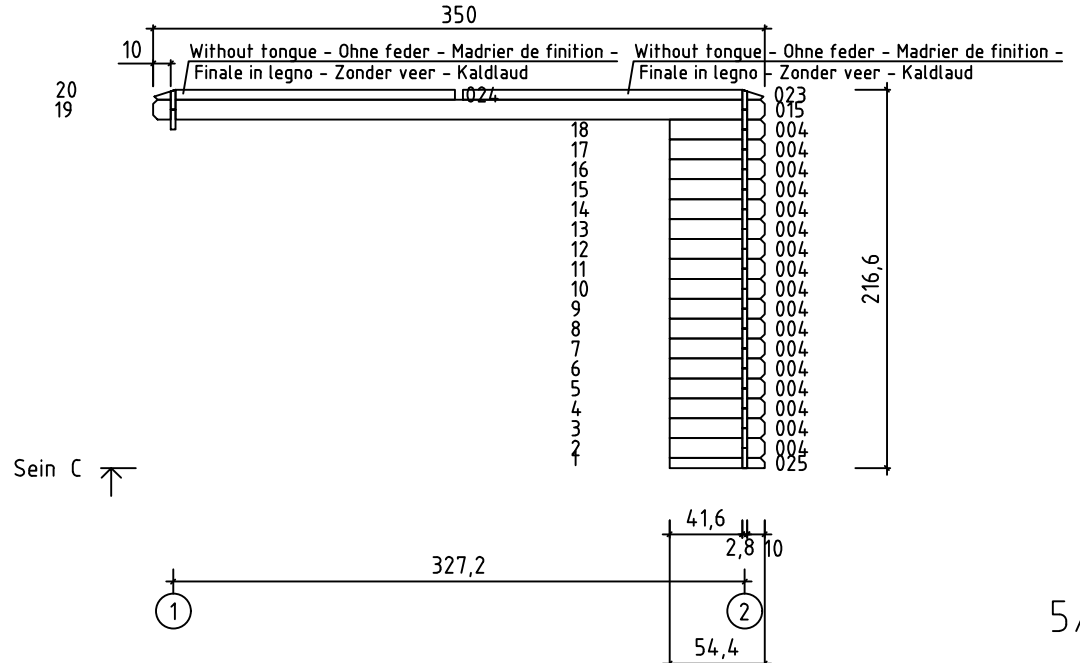
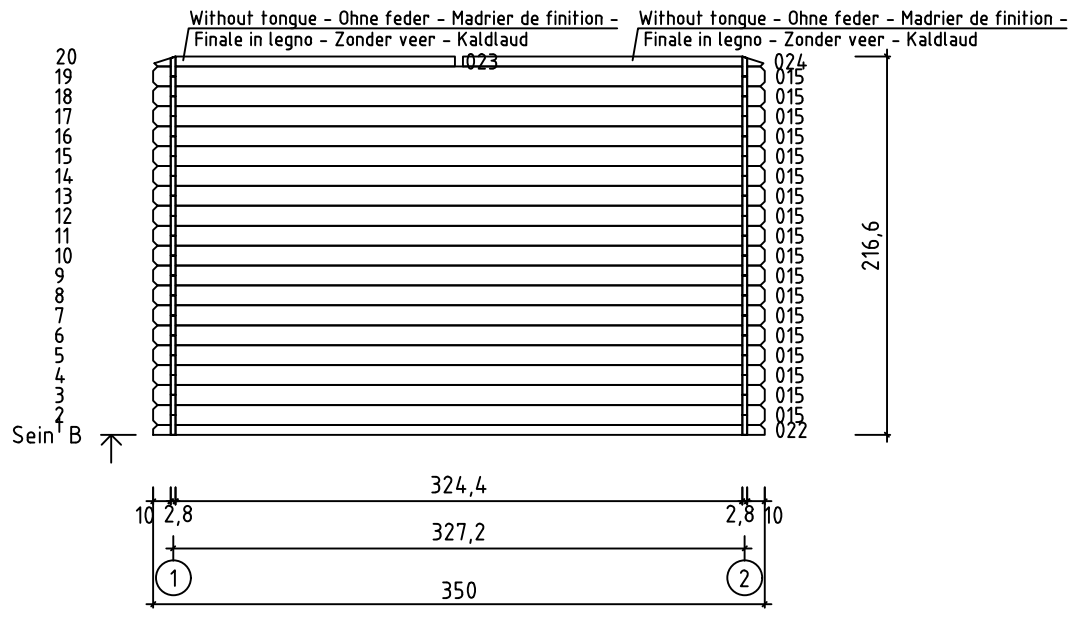
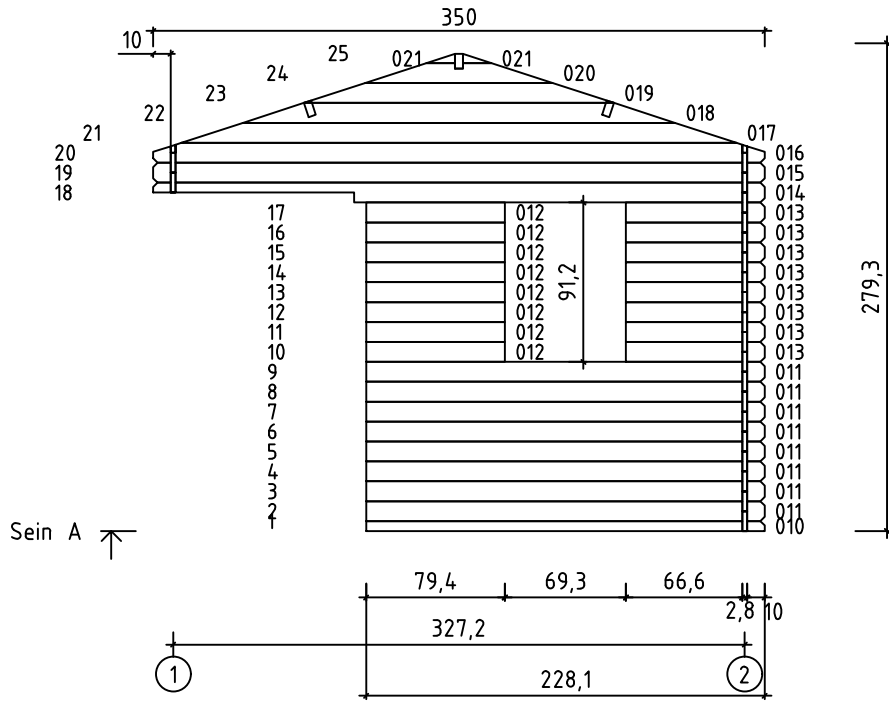

Art. Nr. 2839496

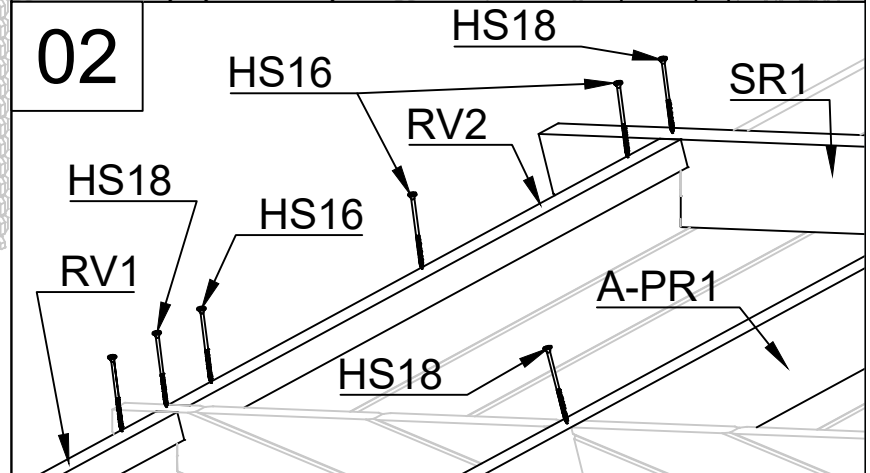
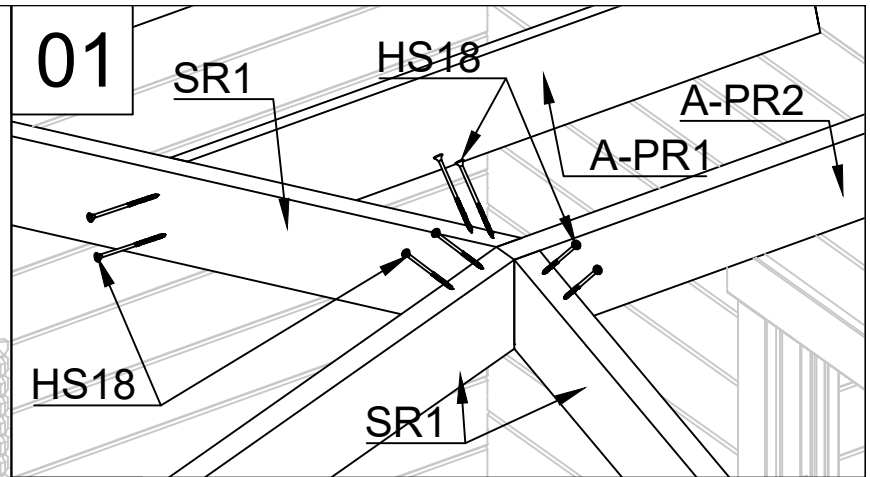
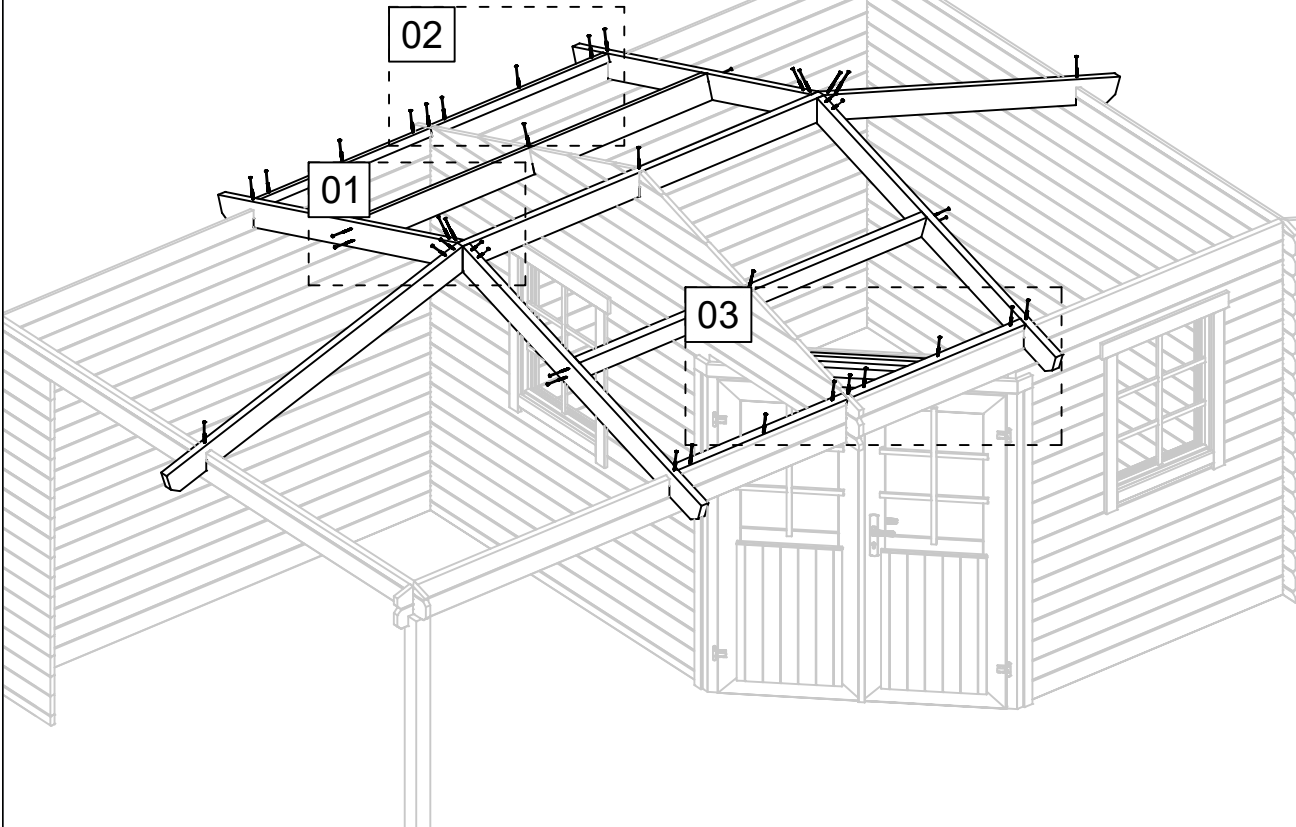

04

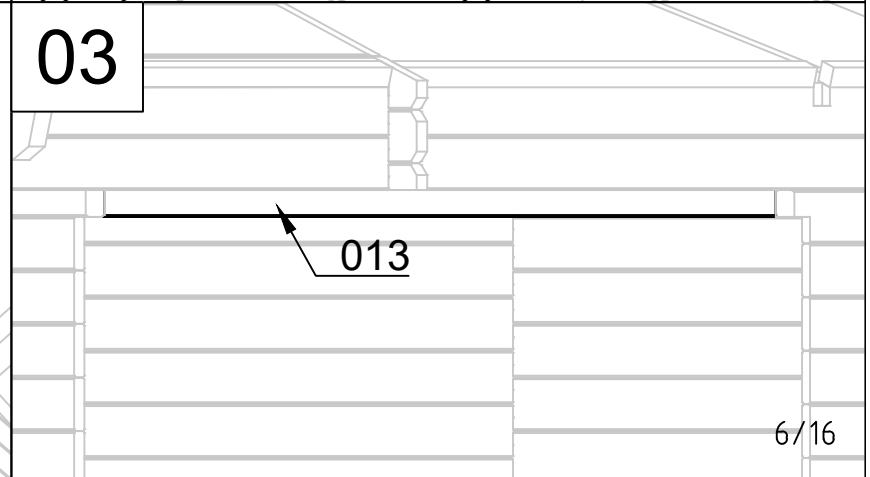
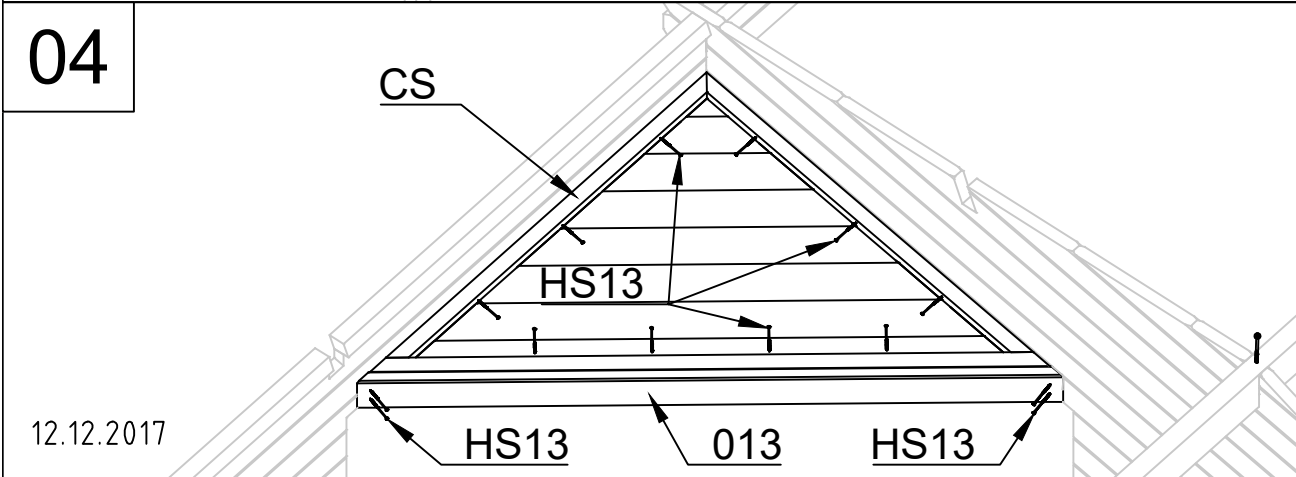

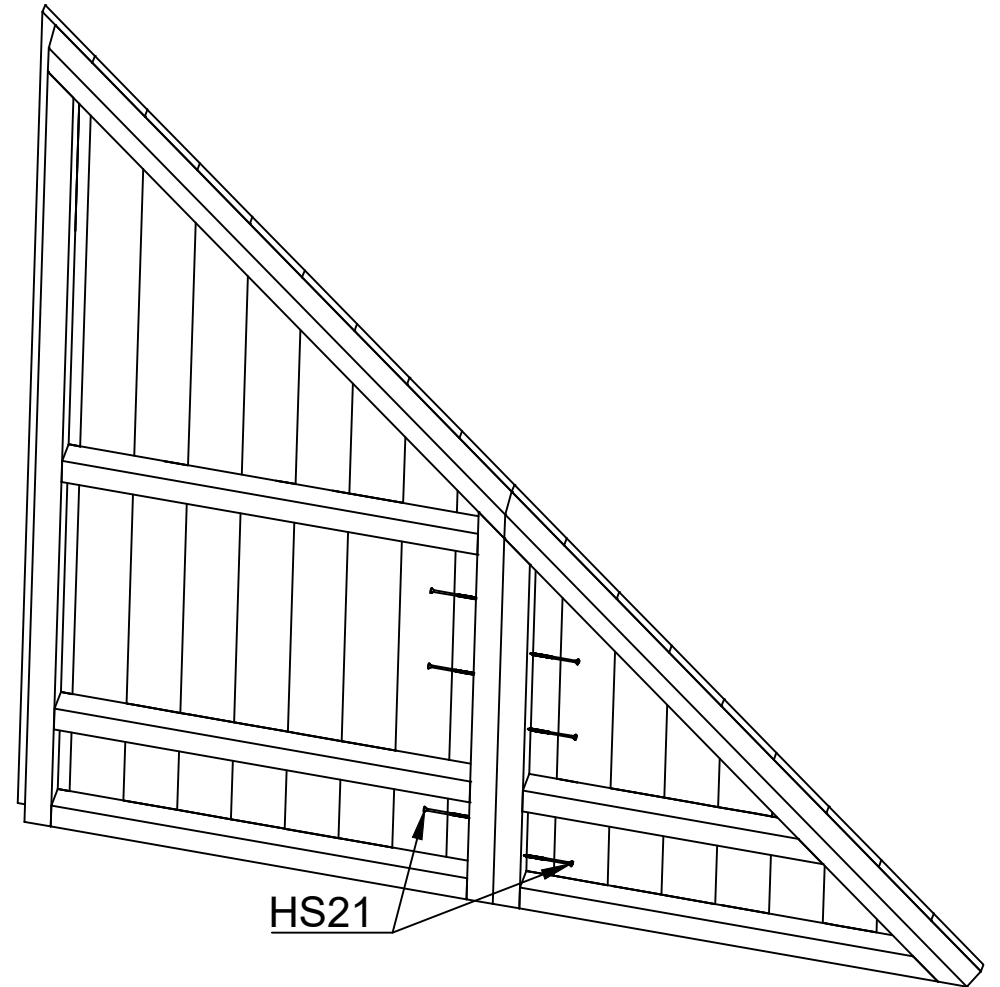
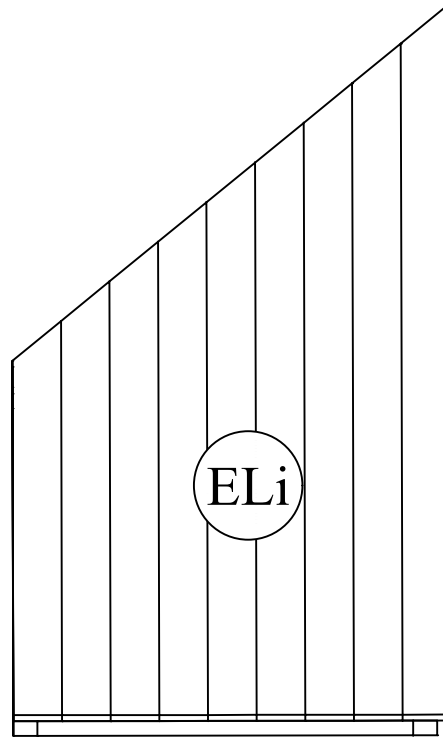
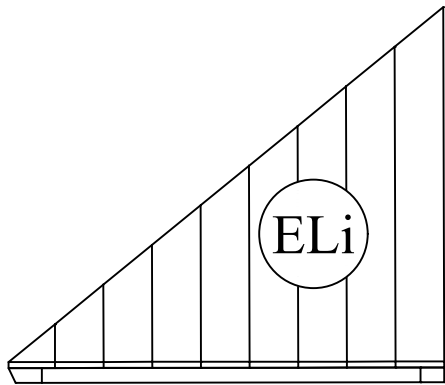

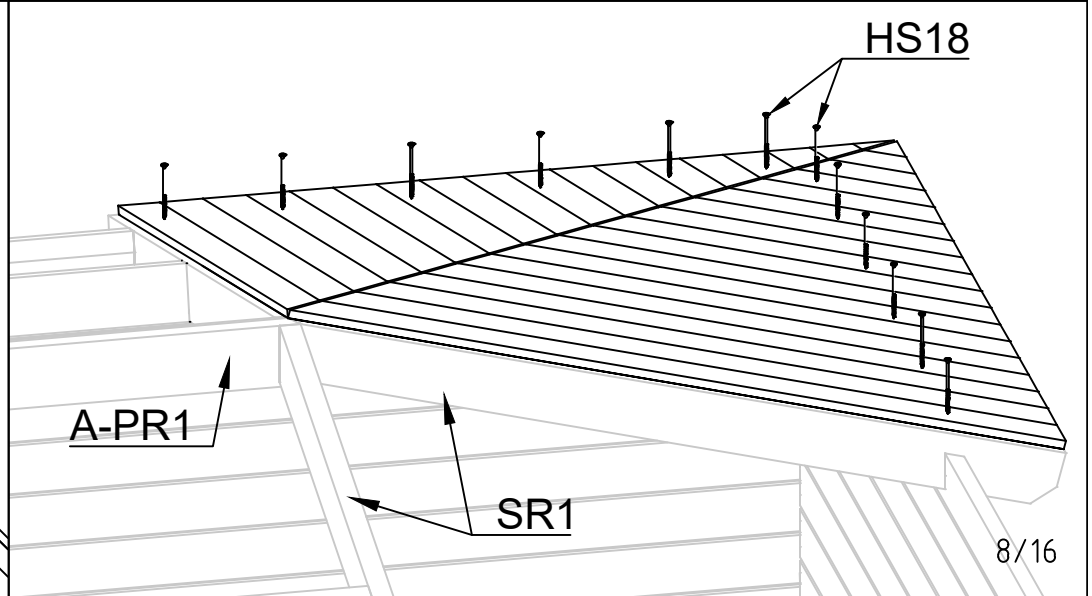
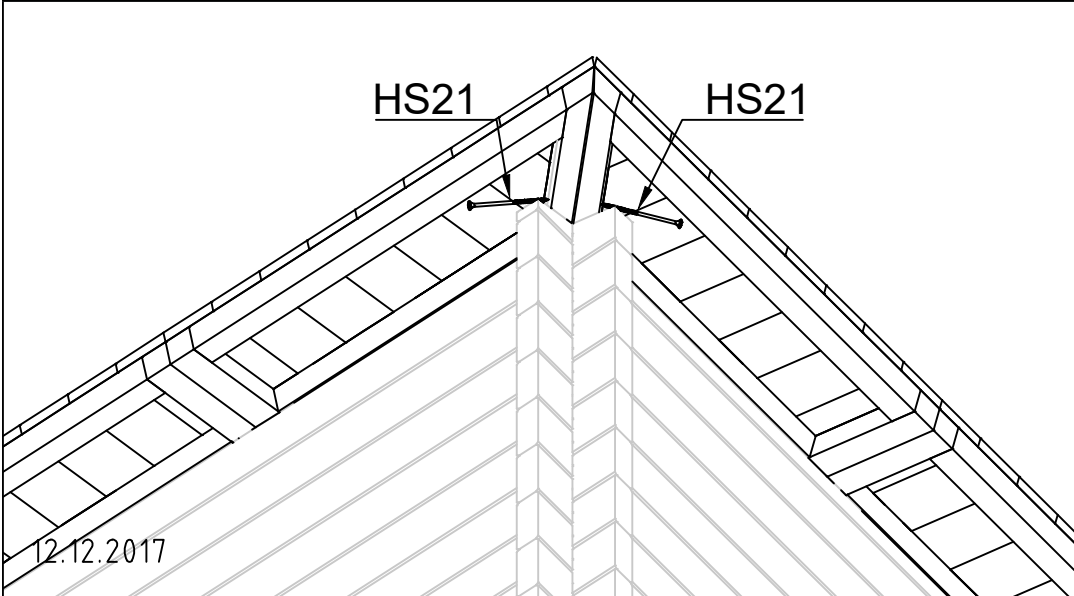
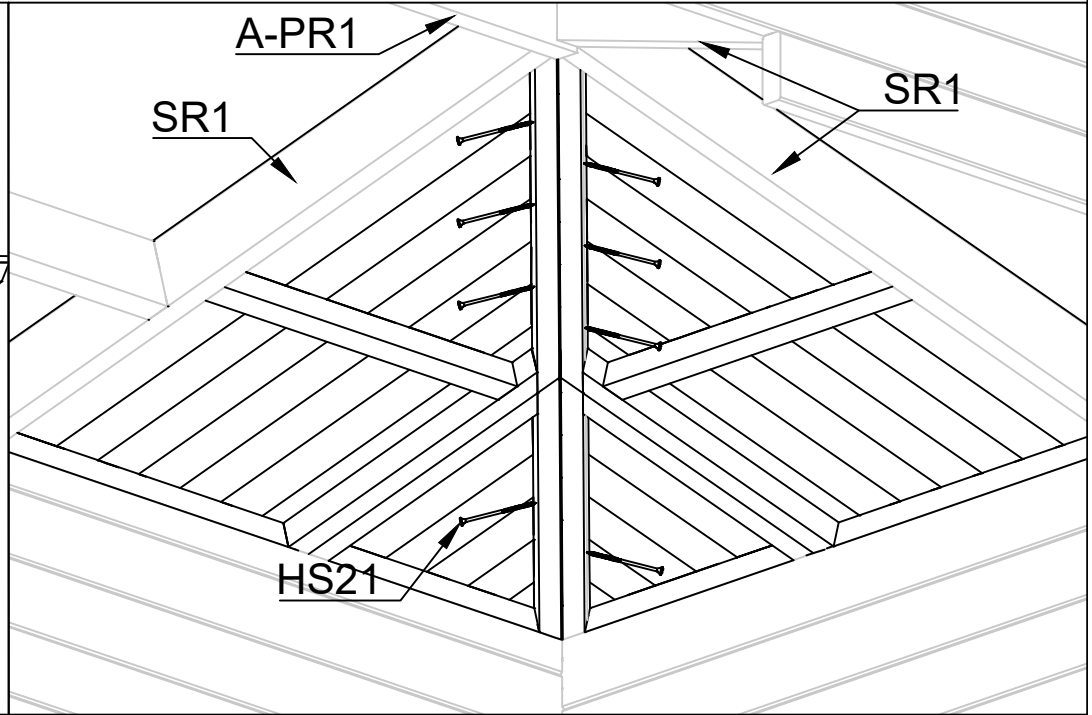
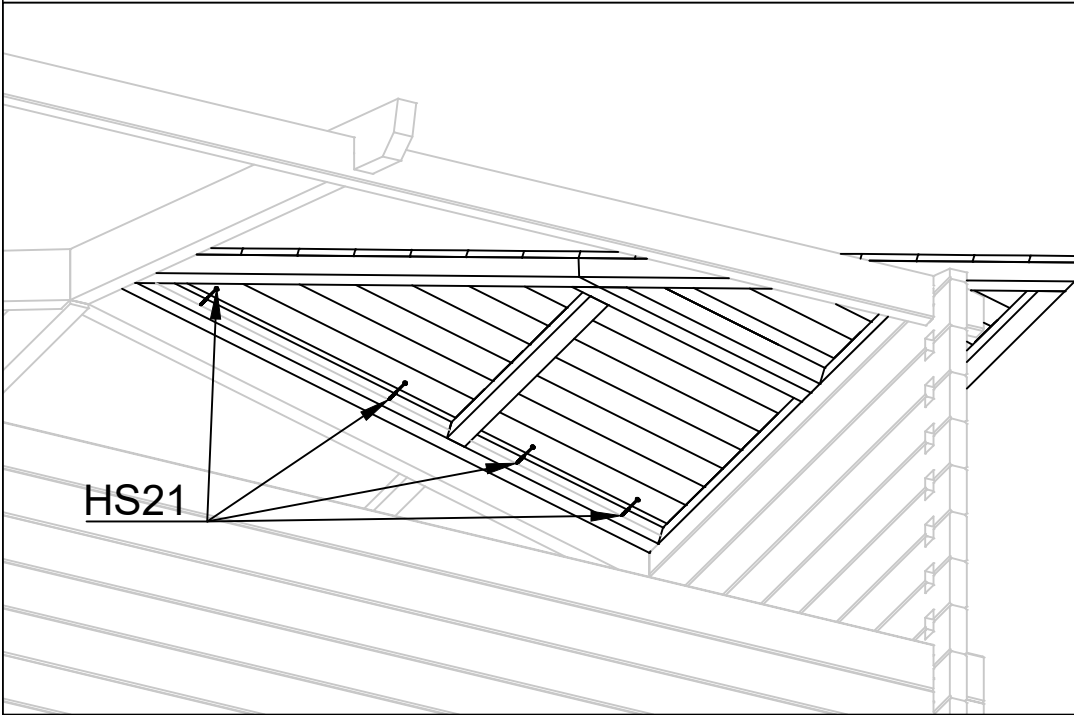

1

Art. Nr. 2839496

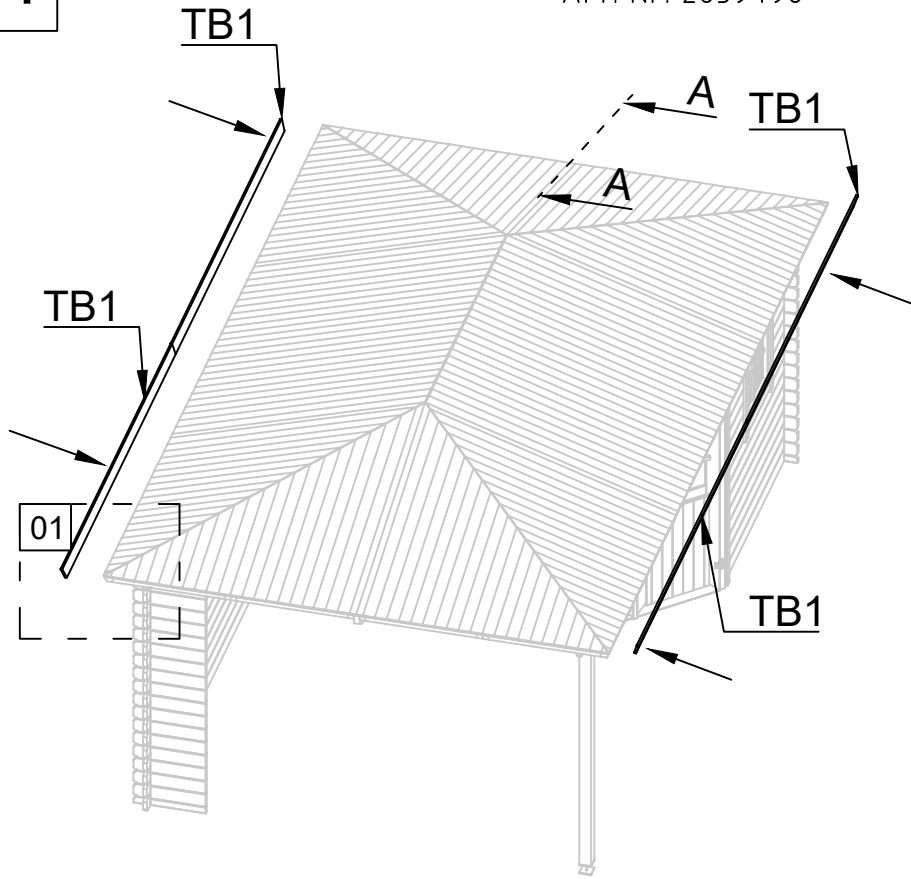

A-A

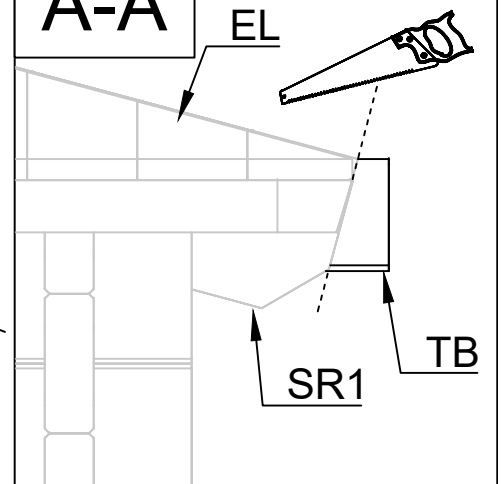

01

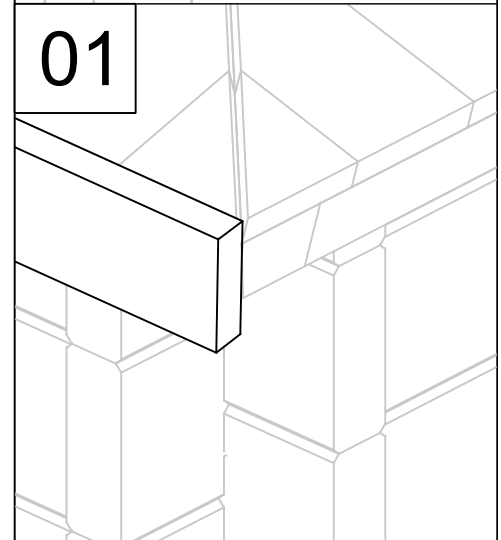

2

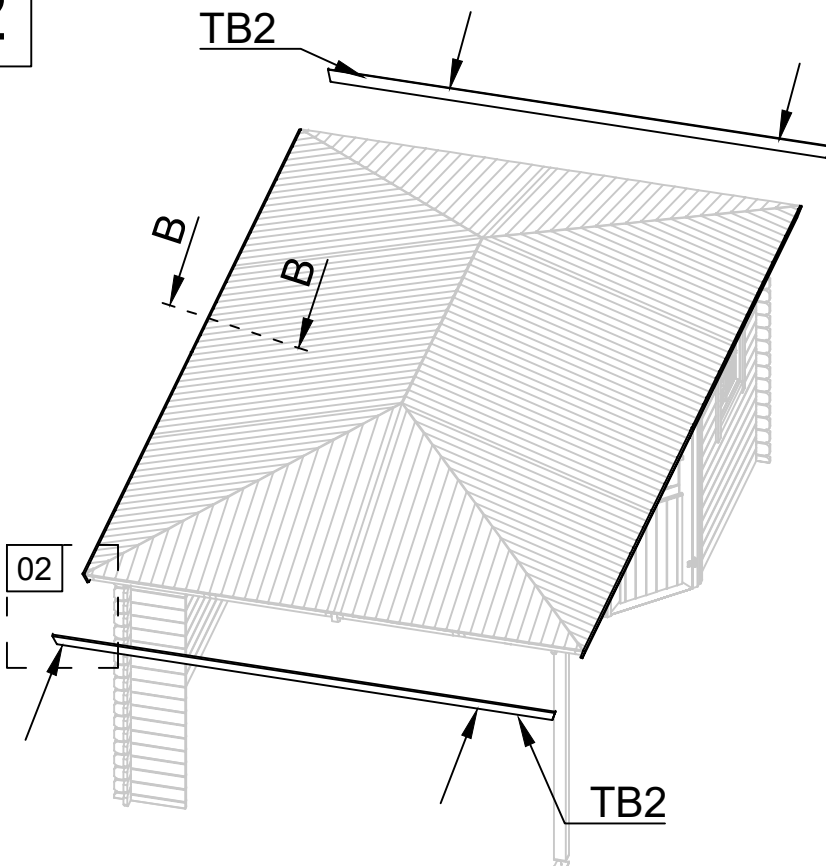

B-B

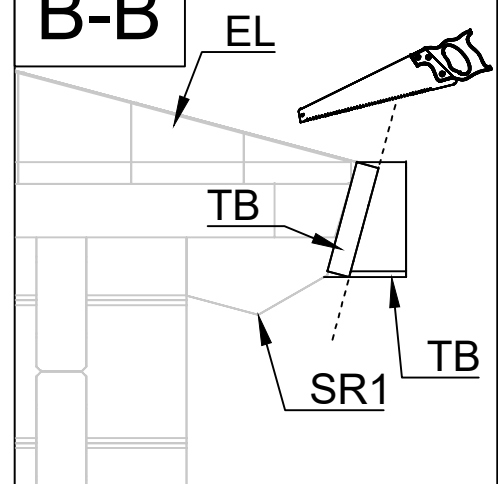



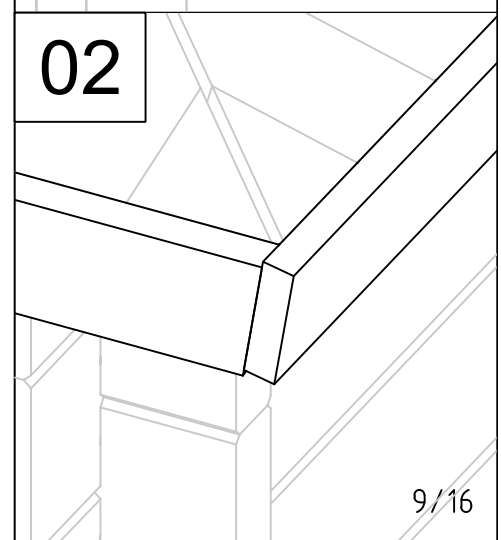



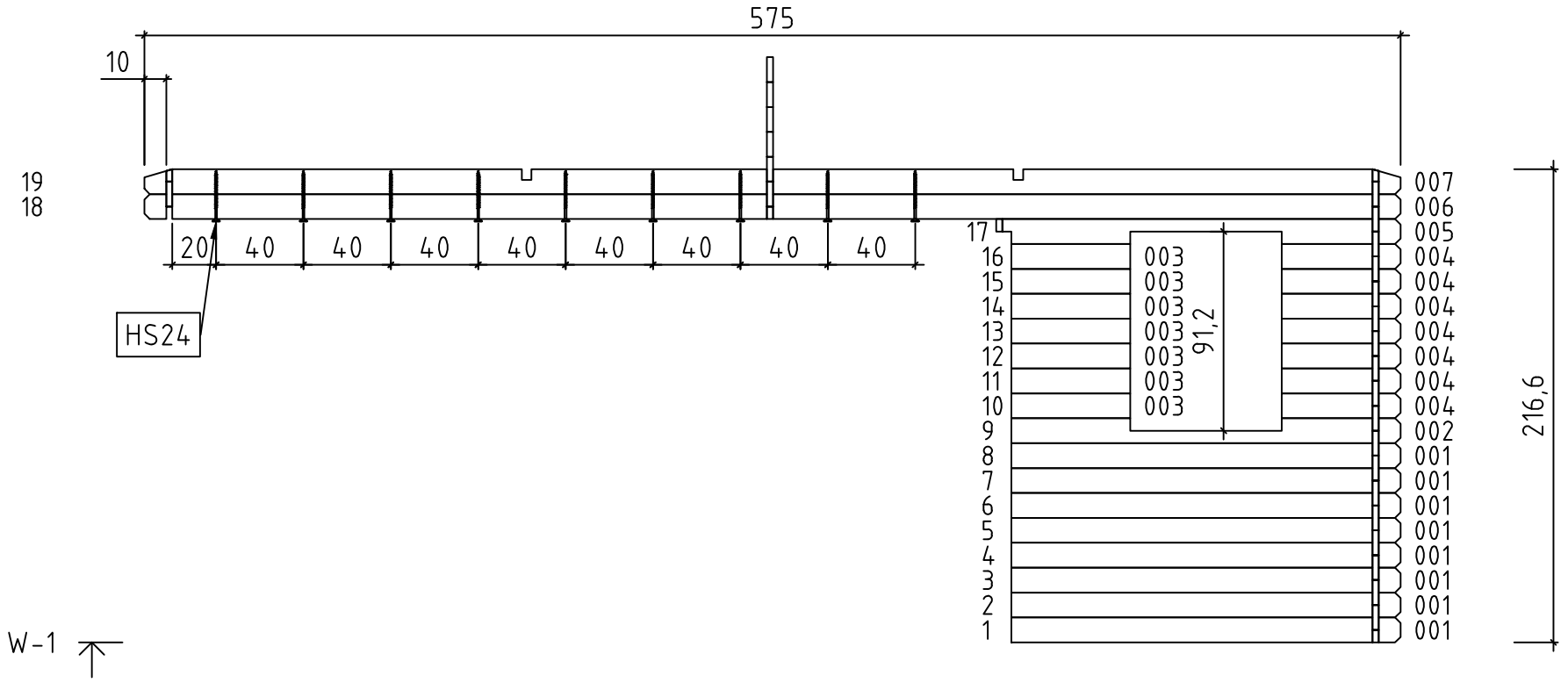

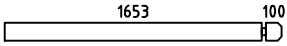
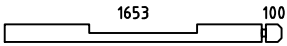

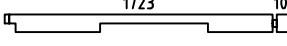
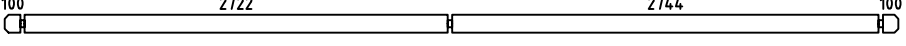
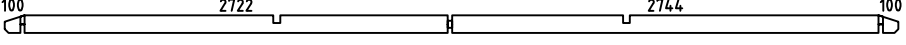
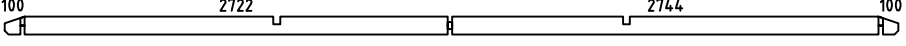
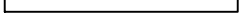
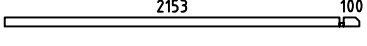
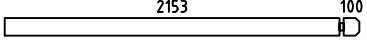
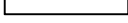
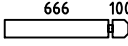
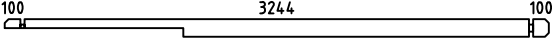
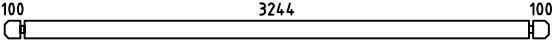
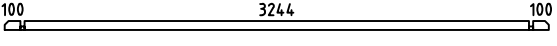
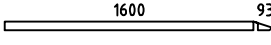
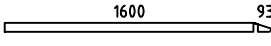
02

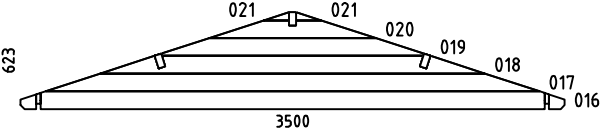

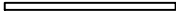

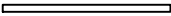
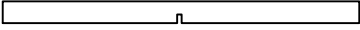
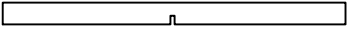
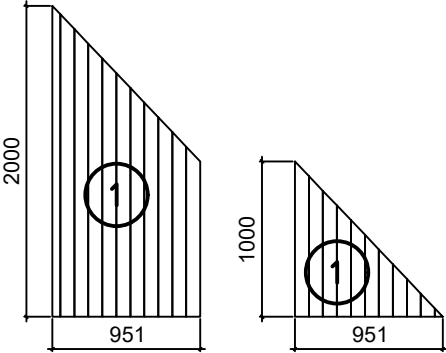
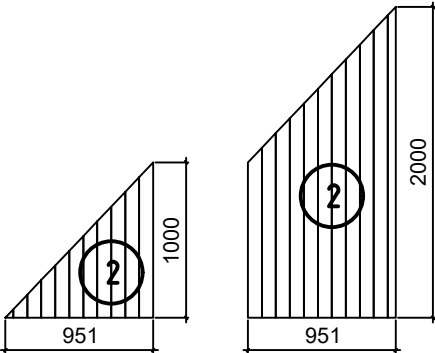
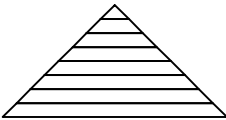
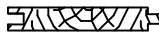

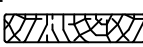
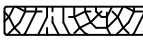

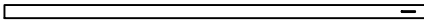
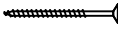
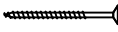



Art. Nr. 2839496

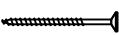

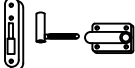
Pos	12.12.2017 Piece list - Stückliste - Liste des pièces - Elementi - Stuklijst - Tükítabel Art. Nr. 2839496 11/16	Q	P (mm)	L (mm)
001		8	28x114	1781
002		1	28x114	1781
003		7	28x114	544
004		24	28x114	544
005		1	28x114	1851
006		19	28x114	5750
007		1	28x114	5750
008		1	28x114	5750
009		1	28x114	1499
010		1	28x57	2281
011		8	28x114	2281
012		8	28x114	794
013		8	28x114	794
014		1	28x114	3500
015		20	28x114	3500
022		1	28x57	3500
023		2	28x57	1721
024		2	28x57	1721
025		1	28x57	544
WA-1		1		
SR1	Rafter - Dachsparren - Chevron - Trave - Dak spar - Sarikas 	6	44x140	1977
RV2	Lath - Pfetten - Liteau - Piccola asse - Gordingen - Roov 	2	44x44	1100

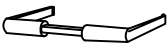

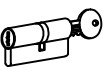
Pos	12.12.2017 Piece list - Stückliste - Liste des pièces - Elementi - Stuklijst - Tükítabel Art. Nr. 2839496	12/16	Q	P (mm)	L (mm)
RV1	Lath - Pfetten - Liteau - Piccola asse - Gordingen - Roov 		2	44x44	1078
A-PR2	Roof beam - Dachbalken - Panne de toit - Perlina del tetto - Gordingen / dakbalk - Pärlin 1122 1144 		1	44x140	2294
A-PR1	Roof beam - Dachbalken - Panne de toit - Perlina del tetto - Gordingen / dakbalk - Pärlin 1078 1100 		2	44x140	2206
	Roof element - Dachelement - Panneau de toit pré-monté - Componente del tetto - Dakelement - Katusekilp 		4 4	62x951 62x951	2000 1000
	Roof element - Dachelement - Panneau de toit pré-monté - Componente del tetto - Dakelement - Katusekilp 		4 4	62x951 62x951	2000 1000
CS	Ceiling shield - Element - Panneau de toiture - Pannello del soffitto - Plafond bedeking - Laekilp 		1	46x722	1443
	Roof boards - Dachbretter - Voliges - Perlina per tetto - Dakhout - Katuselaud 		50	90x15	2000
	Post - Pfosten - Poteau - Piede registrabile - Stijl - Post 		1	90x90	1915
TB-1	Fascia board - Traufbrett - Bandeau de toit - Finitura lati tetto - Gevellijst - Räästalaud 		4	15x90	3095
TB-2	Fascia board - Traufbrett - Bandeau de toit - Finitura lati tetto - Gevellijst - Räästalaud 		2	15x90	3940
DRV-1	Roof edge reinforcement - Dachrandverstärkung - Corniere de renfort de bord de toit - Rinforzo x tetto - Dakrand versterking - Räästatugevdus 		2	44x44	2206
KFS-1	Storm protection - Sturmleiste - Latte anti-tempete - Protezione anti vento - Stormverankering / beveiliging - Tormikinnitusliist 		5	22x45	2500
HS14	Screw for post - Schrauben für pfosten - Vis de fixation des poteaux - Viti per inviare - Schroef voor stijlen - Kruvi postile 		2	4.5x80	
HS12	Screw for fascia boards - Schrauben für traufbretter - Vis pour fixation bandeau de toit - Viti x striscia del tetto - Schroef voor gevellijst - Kruvi räästalauale 		46	4x40	

Pos	12.12.2017 Piece list - Stückliste - Liste des pièces - Elementi - Stuklijst - Tükítabel 1494x1850 TUK.2.056.SVP.MX28.5 SGA+28	14/16	Q	P (mm)	L (mm)
HS1	Screw for georgian bars - Schraube für sprossen - Vis pour croisillons - Viti per unire la griglia georgiana della finestra - Schroeven voor raamverdeling - Kruvi ukse peffeliistule		12	2.5x20	
HS9	Screw for fixing door to the wall - Schraube zur Befestigung für - zarge mit wand - Vis de fixation partie basse dormants de porte au 1er rang de madrier - Viti per fissare la porta alla parete - Schroef voor bevestiging deur naar wand - Kruvi ukse selengi kinnifamiseks seinale		2	3.5x50	
HS4	Screw for doorstep - Schrauben für swelle - Vis pour fixation barre de seuil - Vite per soglia della porta - Schroef voor deurdorpel - Kruvi lävepakule		3	3x30	
HS4	Screw for door fillet - Schraube zur Befestigung türleiste - Vis pour fixation baguette d'arrêt de porte - Viti per massellino della porta - Schroef voor deurlijst - Kruvi ukse kokkuvaltsiliistule		5	3x30	
HS11	Screw for fixing bolt hinge - Schraube für türband - Vis pour fixation gonds de porte - pour ouvrant - Viti per fissaggio cardini e cerniere della porta - Schroef voor scharnier - Kruvi ukse polthingele		16	4x30	
HS12	Screw for covering moulding - Schrauben für deckungsprofil - Vis de fixation profils horizontaux haut inférieur et extérieur d'encadrement de porte - Vite per cornice di copertura - Schroef voor afdekprofiel - Kruvi piirdelauale		26	4x40	
HS12	Screw for fixing bolt hinge - Schraube für türband - Vis pour fixation gonds de porte - pour ouvrant - Viti per fissaggio cardini e cerniere della porta - Schroef voor scharnier - Kruvi ukse polthingele		12	4x40	
HS16	Screw for door jamb - Schraube für türrahmen - Vis de fixation partie haute avec montants du cadre de porte - Viti x fissaggio montanti porte - Schroef voor deurkozijn - Kruvi ukse lengile		4	5x90	
	Male bolt hinge for door - Türband - Partie male de paumelle de porte - Cerniera anube x porta - Scharnier bout - Polthing adapteriga		4		
TL	Latch bolt for double door - Türriegel - Loquet pour double porte - Scrocco per porta doppia - Nachtslot - Riiv		2		
TL4	Door handle fittings - Türgriff - Poignée de porte - Maniglie - Deurhendel / klink - Ukse käepide		1		
TL5	Set of door lock covers - Schlossblenden - Set de garnitures de porte - Copertura serrature - Slot sluitplaat set - Ukse lukuplaat		1		
	Cylinder lock - Zylinderschloss - Barillet de porte - Serratura - Cylinder slot - Ukse lukusüdamik		1	30x30	

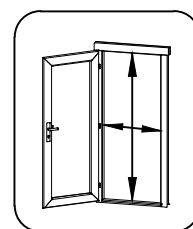
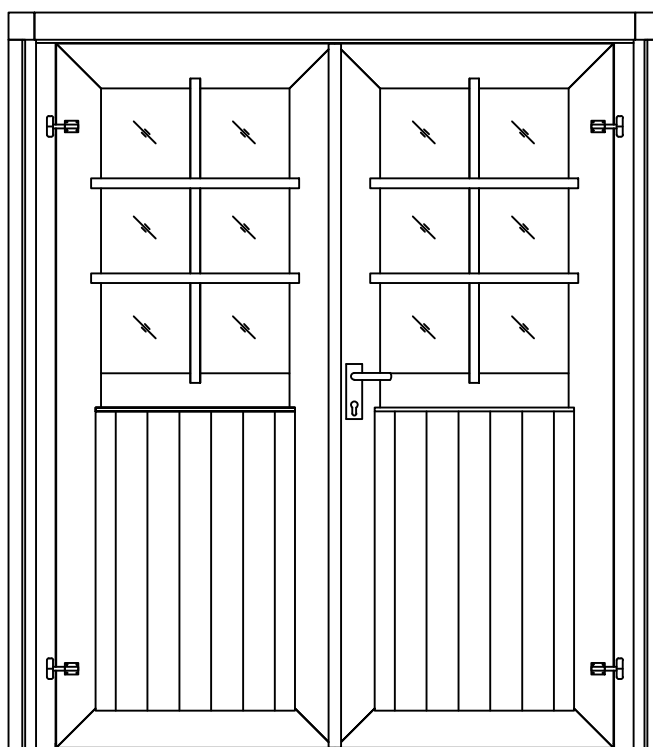
Glass size - Glasgröße - Taille de la vitre - Misura del vetro - Glas afmeting - Klaasi mõõt: 502x750 mm

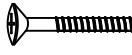

1418x1794 mm

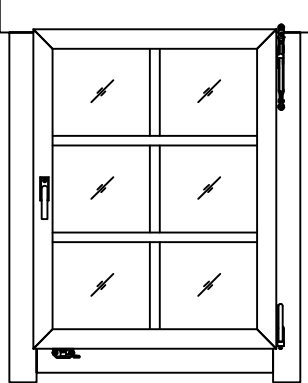
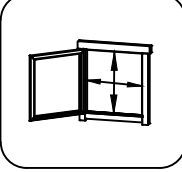
Pos	12.12.2017 Piece list - Stückliste - Liste des pièces - Elementi - Stuklijst - Tükitalabel 685x882 AK.1.106.SSP.d SGC 15/16	Q	P (mm)	L (mm)
FS1	Window handle fittings - Fenstergriff - Poignée de fenetre - Maniglia c/ferramenta - Raamhendel -/grendel -/klink - Aknalink 	1		
FSP	Bolt for window handle fittings - Bolzen für fenstergriff beschlag - Vis pour fixation poignée de fenetre - Bullone x apertura manuale finestra - Schroef voor raamhendel - Akna käepideme polt 	2		
HS1	Screw for georgian bars - Schraube für sprossen - Vis pour croisillons - Viti per unire la griglia georgiana della finestra - Schroeven voor raamverdeling - Krugi akna petteliistule 	6	2.5x20	
<p data-bbox="263 421 1284 452">Glass size - Glasgröße - Taille de la vitre - Misura del vetro - Glas afmeting - Klaasi mõõt: 542x738 mm</p>   <p data-bbox="1369 622 1487 654">585x782 mm</p>				

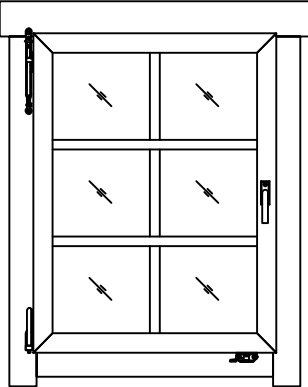
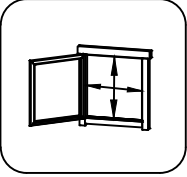
Pos	Piece list - Stückliste - Liste des pièces - Elementi - Stuklijst - Tükitabel 12.12.2017 685x882 AK.1.106.SSV.d SGC 16/16	Q	P (mm)	L (mm)
FS1	Window handle fittings - Fenstergriff - Poignée de fenetre - Maniglia c/ferramenta - Raamhendel -/grendel -/klink - Aknalink	1		
FSP	Bolt for window handle fittings - Bolzen für fenstergriff beschlag - Vis pour fixation poignée de fenetre - Bullone x apertura manuale finestra - Schroef voor raamhendel - Akna käepideme polt	2		
HS1	Screw for georgian bars - Schraube für sprossen - Vis pour croisillons - Viti per unire la griglia georgiana della finestra - Schroeven voor raamverdeling - Krugi akna petteliistule	6	2.5x20	
Glass size - Glasgröße - Taille de la vitre - Misura del vetro - Glas afmeting - Klaasi mõõt: 542x738 mm		  <p data-bbox="1369 616 1492 649">585x782 mm</p>		

Allgemeine Montageanleitung - General assembly instructions - Instructions générales de montage

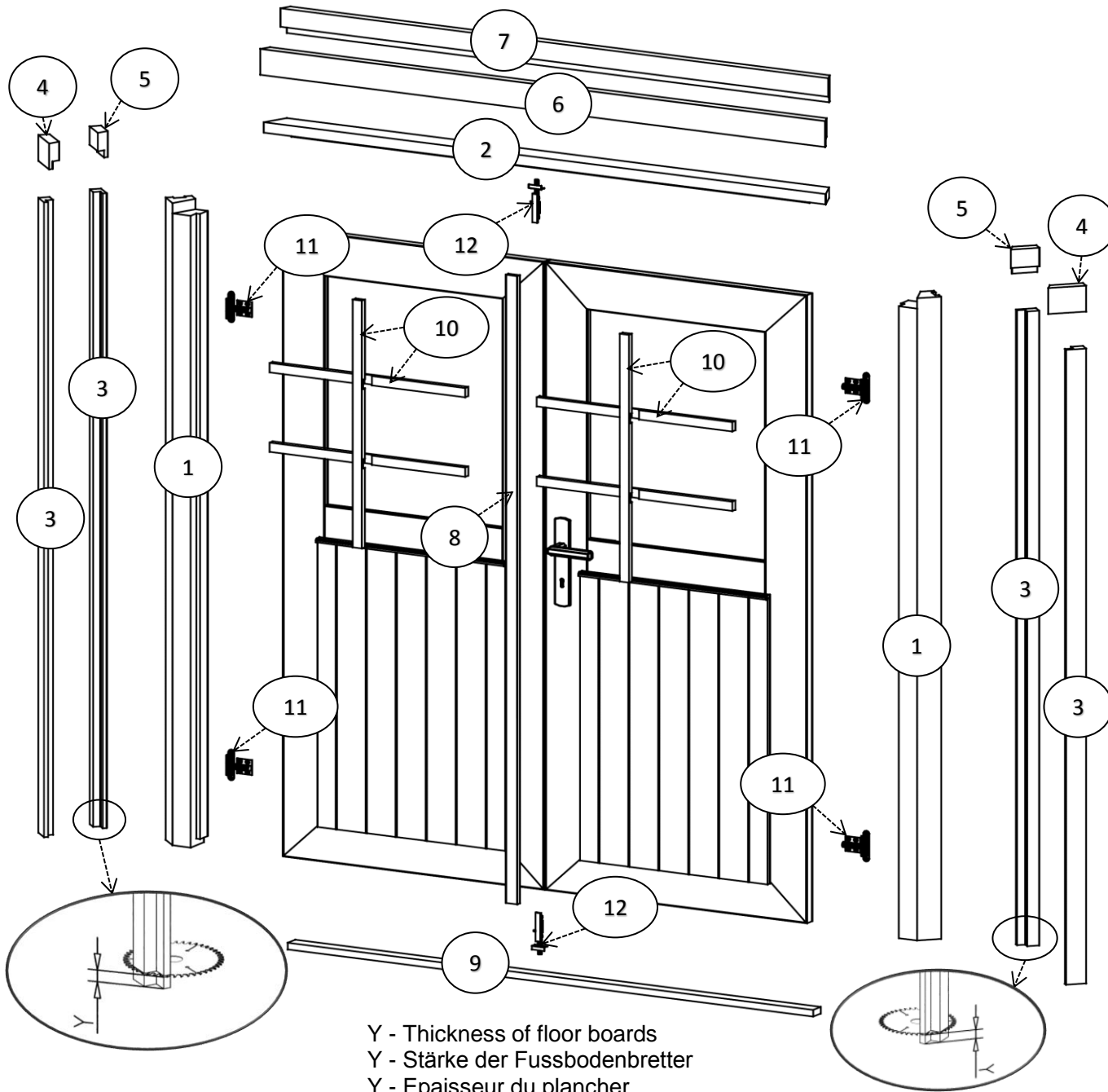

Pos	Piece list - Stückliste - Liste des pièces	Q.	P (mm)	L (mm)
1		2	65x60	1850
2		1	65x38	1538
3		4	28x50	1830
4		2	28x70	94
5		2	28x70	71
6		1	28x70	1546
7		1	28x70	1499
8		1	13x32	1812
9		1	18x37	1438
10		6	15x25	
11		4		
12		2		

Metall Tüschwelle gehört nicht zum Lieferumfang - Metal sill cover not included - Seuil de porte en métal non-inclus

