

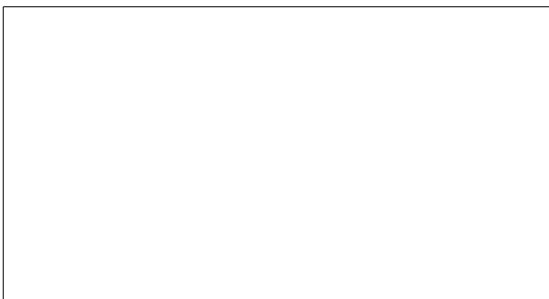

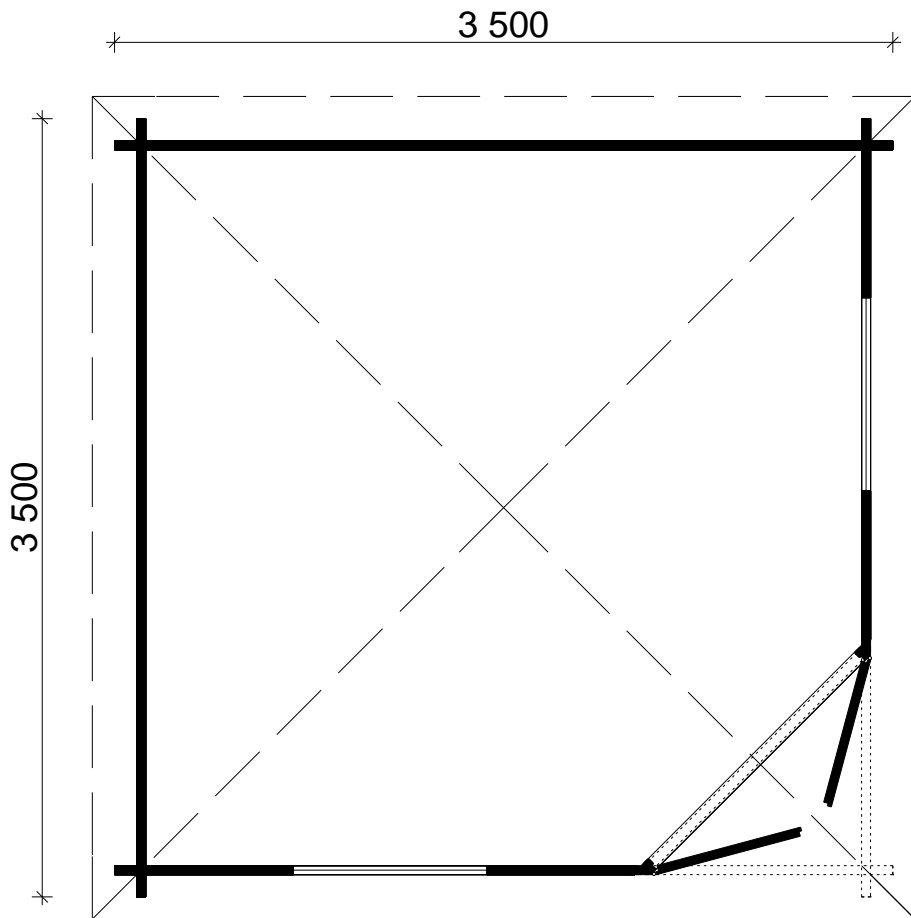







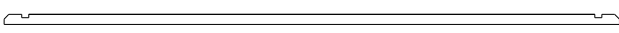

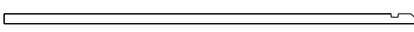
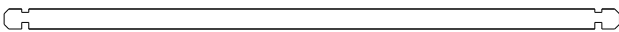

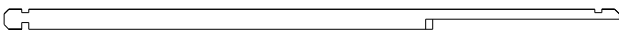
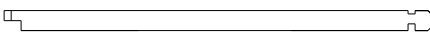
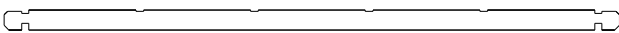
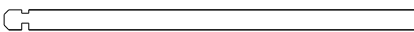

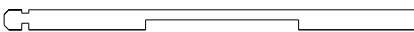
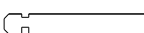
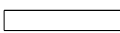
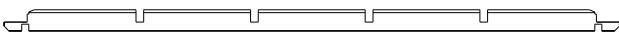
Techn. Data: Aruba

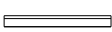
Log length (W x D): 350 x 350 cm Wall size(outside):
330 x 330 cm - Log thickness: 40 mm

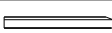
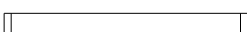





Note: All dimensions are approximate !

Specification Aruba 350x350cm

Nr	Description	Profile mm	Length mm	Quantity	
1	Foundation	45x70	3250/2305	5/1	
2			2720	1	
3			2355	1	
4			1374	2	
5			3500	1	
6			2341	1	
7			3500	37	
8			3500	1	
9			2438	1	
10			3500	2	
11			2341	10	
12			2341	1	
13			2341	1	
14			805	21	
15			666	21	
16				3500	2
17			608	6	
18			619	4(2+2)	
19			1384	1	
20	Rafter	44x94	2725	4	
21	Rafter	44x85	1668	8(4+4)	
22	Rafter		965	8(4+4)	
23	Central fixing block			1	
24	Eavesboard	18x90	3750	4	
25	Double door 1425 x1900 mm			1	
26	Single window 865 x1210 mm			2	
27	Roof element h= 652 mm		1304 x 922	1	
28	Roof board		3694	4	
29			3490	4	
30			3286	4	
31			3082	4	
32			2878	4	
33				2674	4
34			2470	4	
35			2267	4	
36			2063	4	
37			1849	4	
38			1655	4	

Specification - Aruba 350x350cm

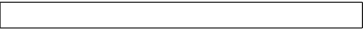
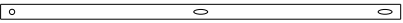
Nr	Description	Profile mm	Length mm	Quantity
39	Roof board 	 18x110	1451	4
40			1247	4
41			1043	4
42			839	4
43			635	4
44			432	4
45			228	4
46			Floor board 	 18x110
47	2467	1		
48	2577	1		
49	2687	1		
50	2797	1		
51	2907	1		
52	3017	1		
53	3127	1		
54	Floor board 		3217	22+1
55	Screws 4,0 x 40; 4,0 x 50; 5,0 x 70; 6,0 x 140			130/700/70/55
56	Nails 1,4 x 35			50
57	Baseboard			ca 12,4 m
58	Storm braces 		2010	5
59	Bolt M 8 x 70, nut, washer			15
60	Nails 3,0 x 15			--

Wall- and Foundation plan Aruba 350 x 350 cm

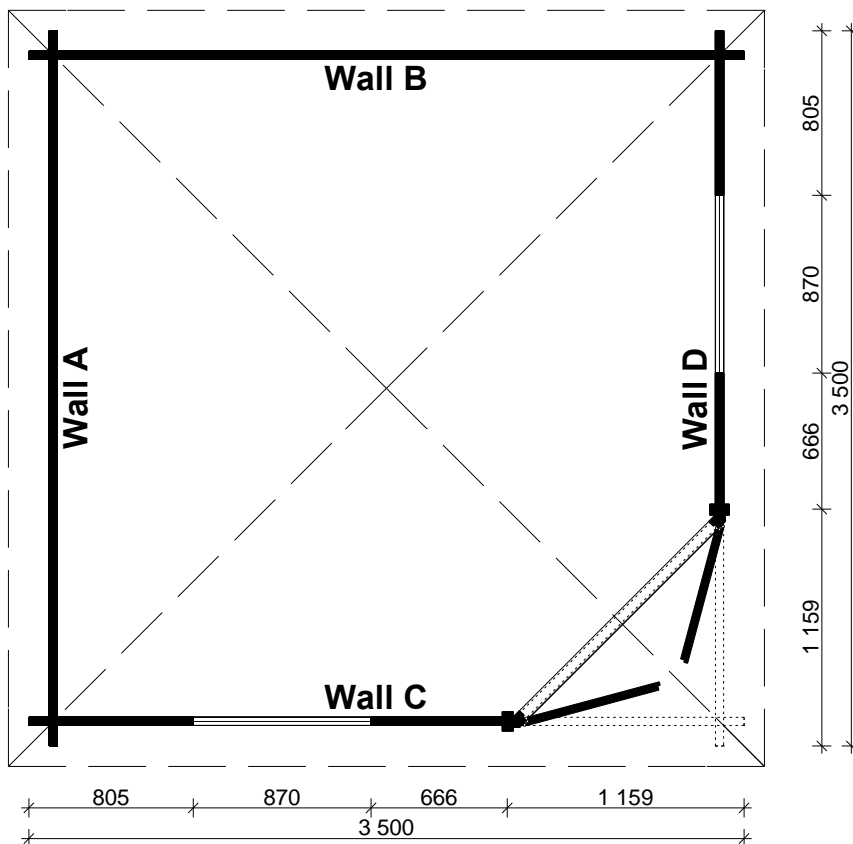
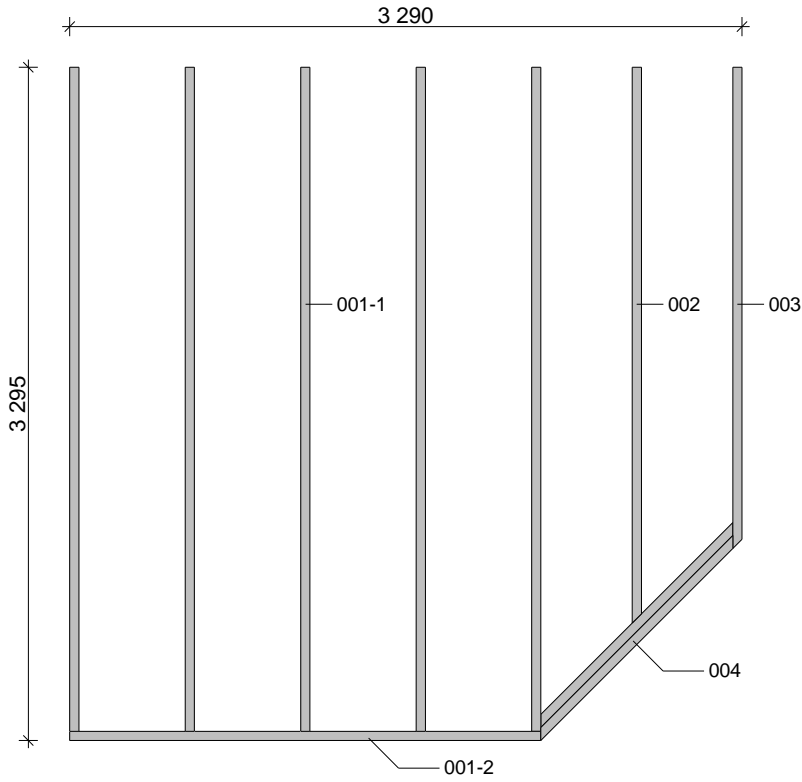

Wall plan Aruba 350x350cm

Wall A

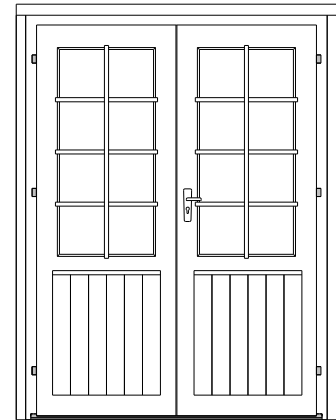
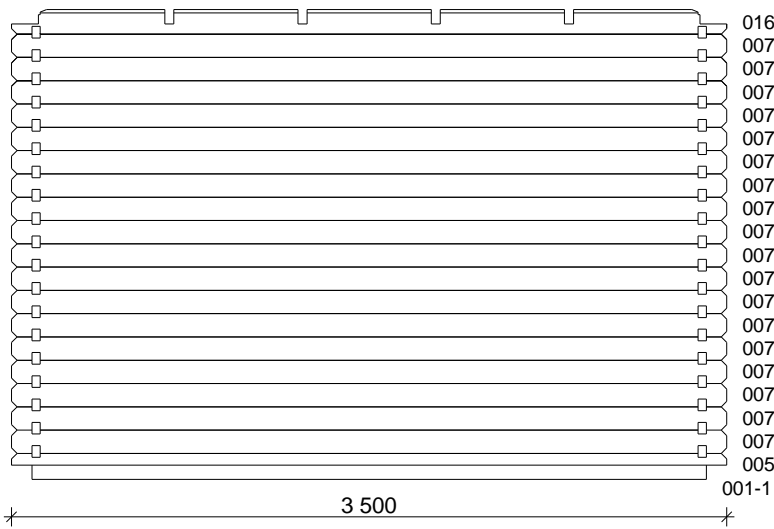

Double door 40 mm straight
1425 x 1900 mm 1 stk

Wall B

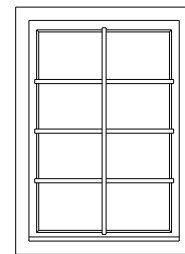
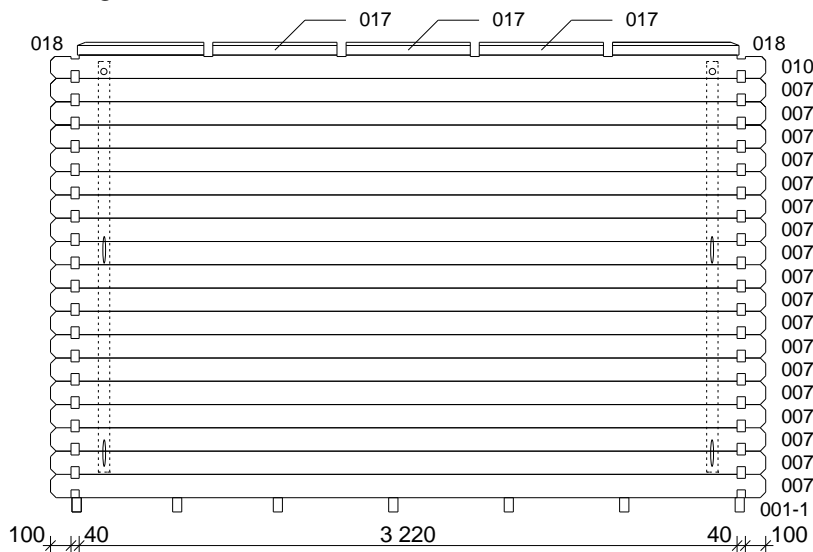

Window 40 mm straight
865 x 1210 mm
2 stk

Wall C

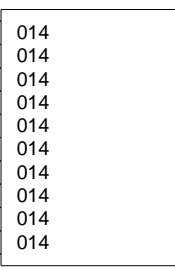
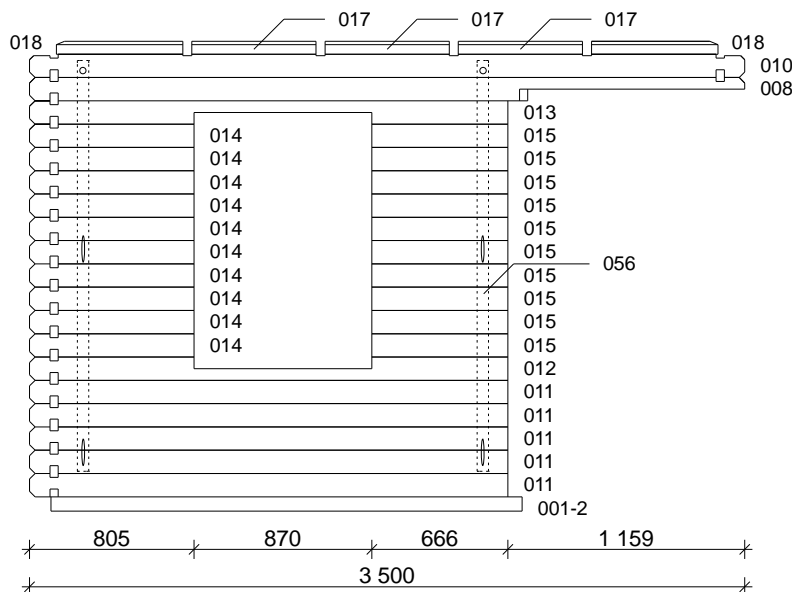

014
014
014
014
014
014
014
014
014
014
015
015
015
015
015
015
015
015
015
015
012
011
011
011
011
011
011

056

Wall plan + Roof Aruba 350x350cm

Wall D

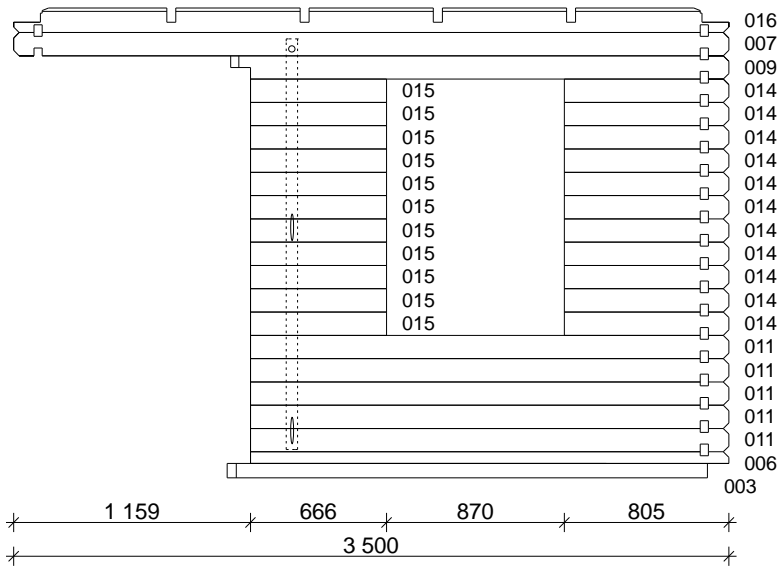

Roof element

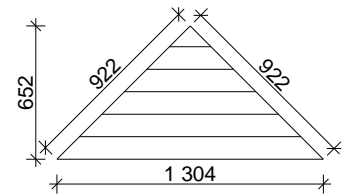

Roof plan

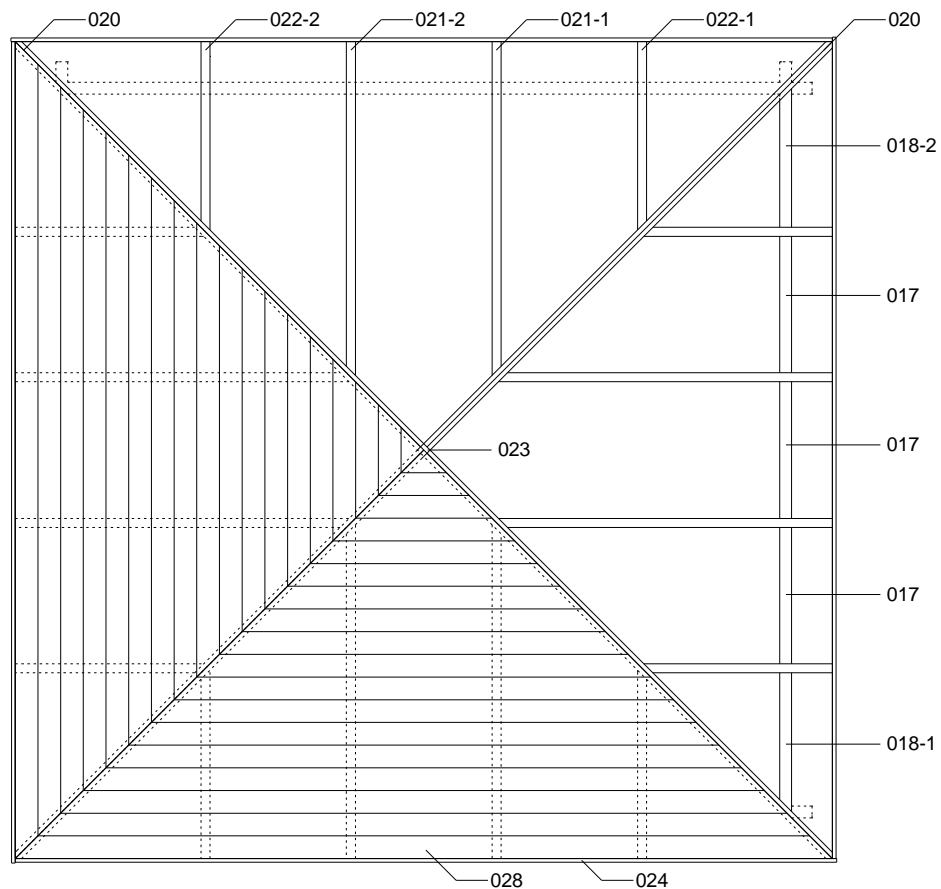

Doppeltür (Wand 40 mm)

Nr	Beschreibung	Profil mm	Stück
1	Rahmen profil Links + Rechts	99 x 82	1+1
2	Rahmen profil Oberteil	58 x 58	1
3	Türschwelle	28 x 58	1
4	Wechselrahmen	28 x 55	2
5			2
6		28 x 70	1
7			1
8			2(1+1)
9			2(1+1)
10	Edelstahlbedeckung für Türschwelle		1

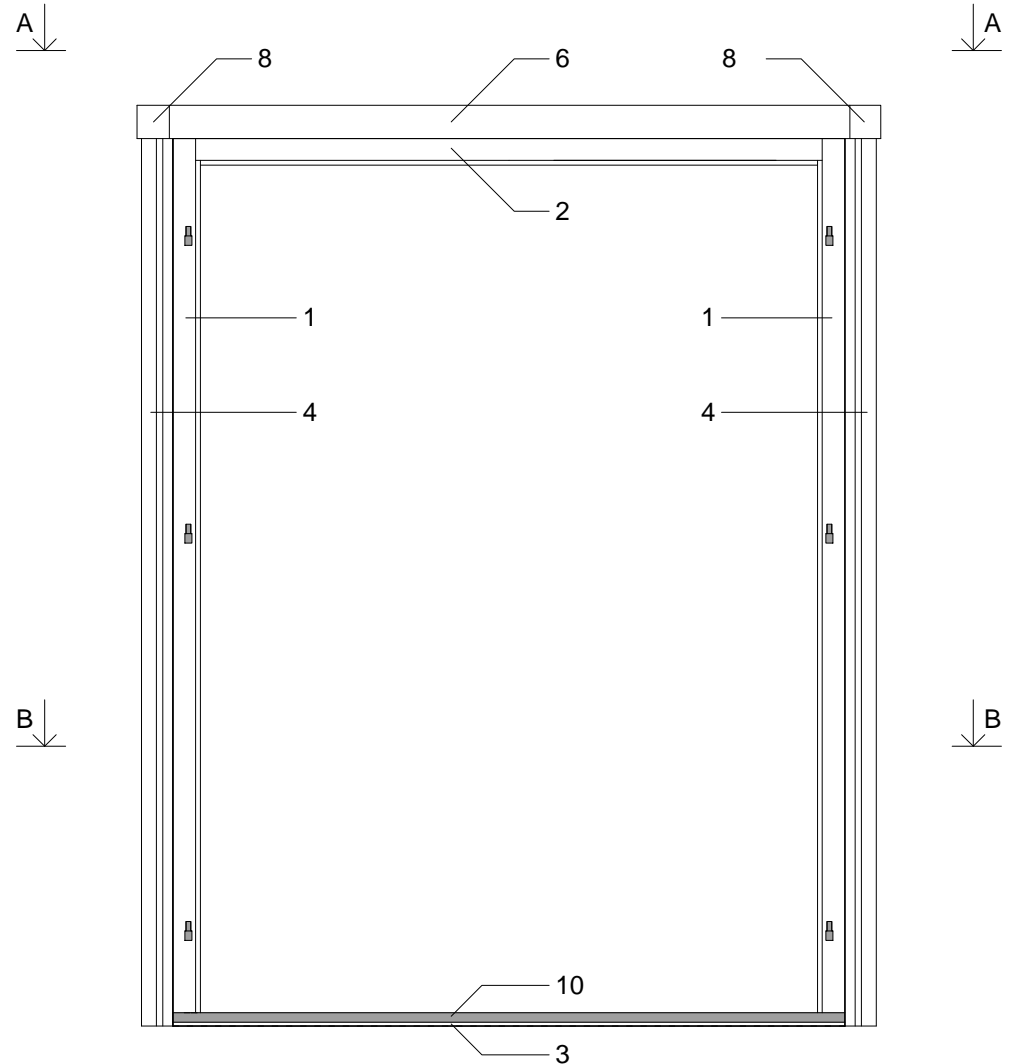

A-A

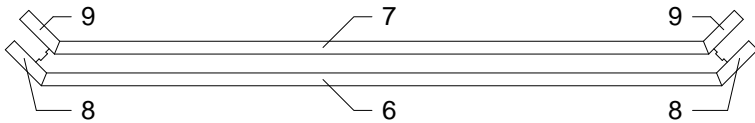

B-B

