

Techn. Daten: Catania

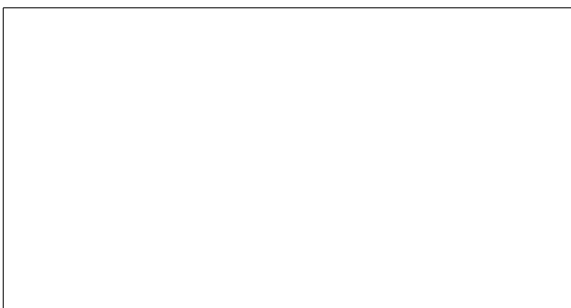

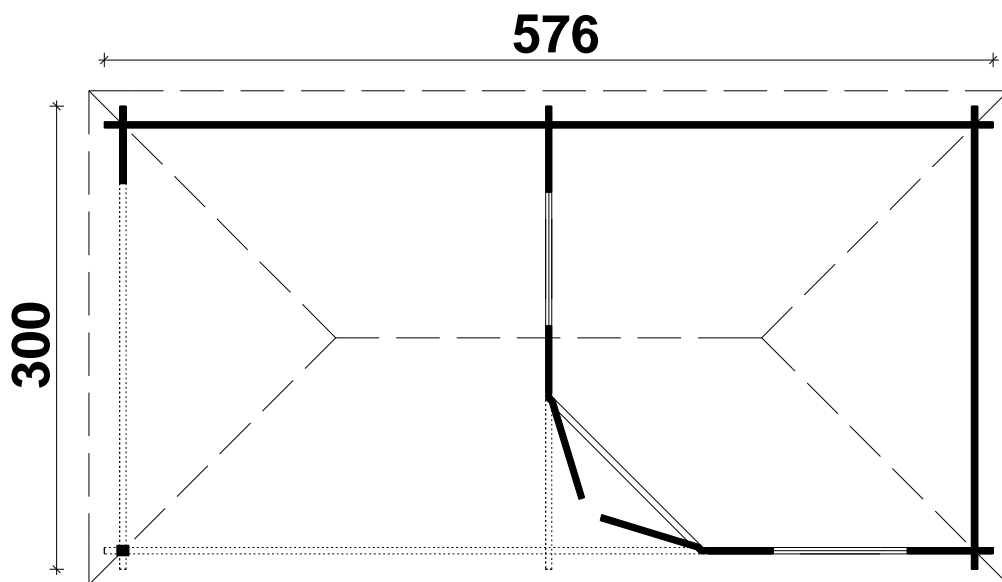







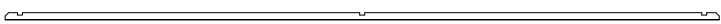

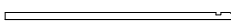









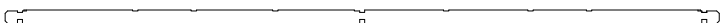
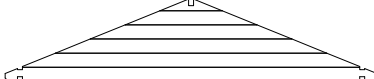





Bohlenaußenmaß (B x T): 576 x 300 cm

Wandaußenmaß: 556 x 280 cm · Bohlenstärke: 40 mm









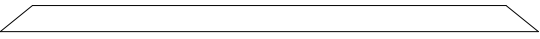

Achtung : Alle angegebenen Maße sind ca. - Maße !

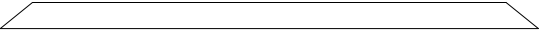
Teileliste Catania 40 mm - 576 x 300 cm

Nr	Beschreibung	Profil mm	Länge mm	Stück
1		 	5760	1
2			1841	1
3			3000	21
4			3000	1
5			3000	1+1
6			5760	19
7			1841	11
100			1841	1
8			555	21
9			416	21
10			1938	1+1
11			500	17
12			5760	2
13		3000	1	
14			3000	2
15			636	4
16			614	4
17			428	4
18			897	4(2+2)
19			1384	1(0+1)
20			3352	1(1+0)
21		44x94	2364	4(2+2)
22	Dachbalken 	44x85	1739	10
23		44x85	1265	8(4+4)
24	Kehlbalken 	18x90	2000	5
25	Traufenbrett	18x110	3250	2
26			5960	2
27	Doppeltür 1425 x1900 mm			1
28	Einzelfenster 865 x1210 mm			2
29	Dachelemente h= 652 mm		1304 x 922	1
30	Schrauben 4,0 x 40; 4,0 x 50; 5,0 x 70; 5,0 x 140		100/700/90/65	
31	Nägel 1,4 x 35			25
32	Dachbretter		3191	2
33			2987	2
34			2783	2
35			2579	2

Teileliste Catania 40 mm - 576 x 300 cm

Nr	Beschreibung	Profil mm	Länge mm	Stück		
36	Dachbretter 	 18x110	2375	2		
37			2171	2		
38			1968	2		
39			1764	2		
40			1560	2		
41			1356	2		
42			1152	2		
43			948	2		
44			744	2		
45			540	2		
46			337	2		
47			133	2		
48			Dachbretter 	 18x110	5951	2
49					5747	2
50	5543	2				
51	5340	2				
52	5136	2				
53	4932	2				
54	4728	2				
55	4524	2				
56	4320	2				
57	4116	2				
58	3912	2				
59	3709	2				
60	3505	2				
61	3301	2				
62	3097	2				
63	2893	2				
64	Fußbodenbretter *  45° 	 18x110	1843	1		
65			1953	1		
66			2063	1		
67			2173	1		
68			2283	1		
69			2393	1		
70			2503	1		
71			2613	1		
72			2717	--		
73			Fußbodenbretter 		2717	17+1

Wandplan Catania 40 mm - 576 x 300 cm - Fundamentplan

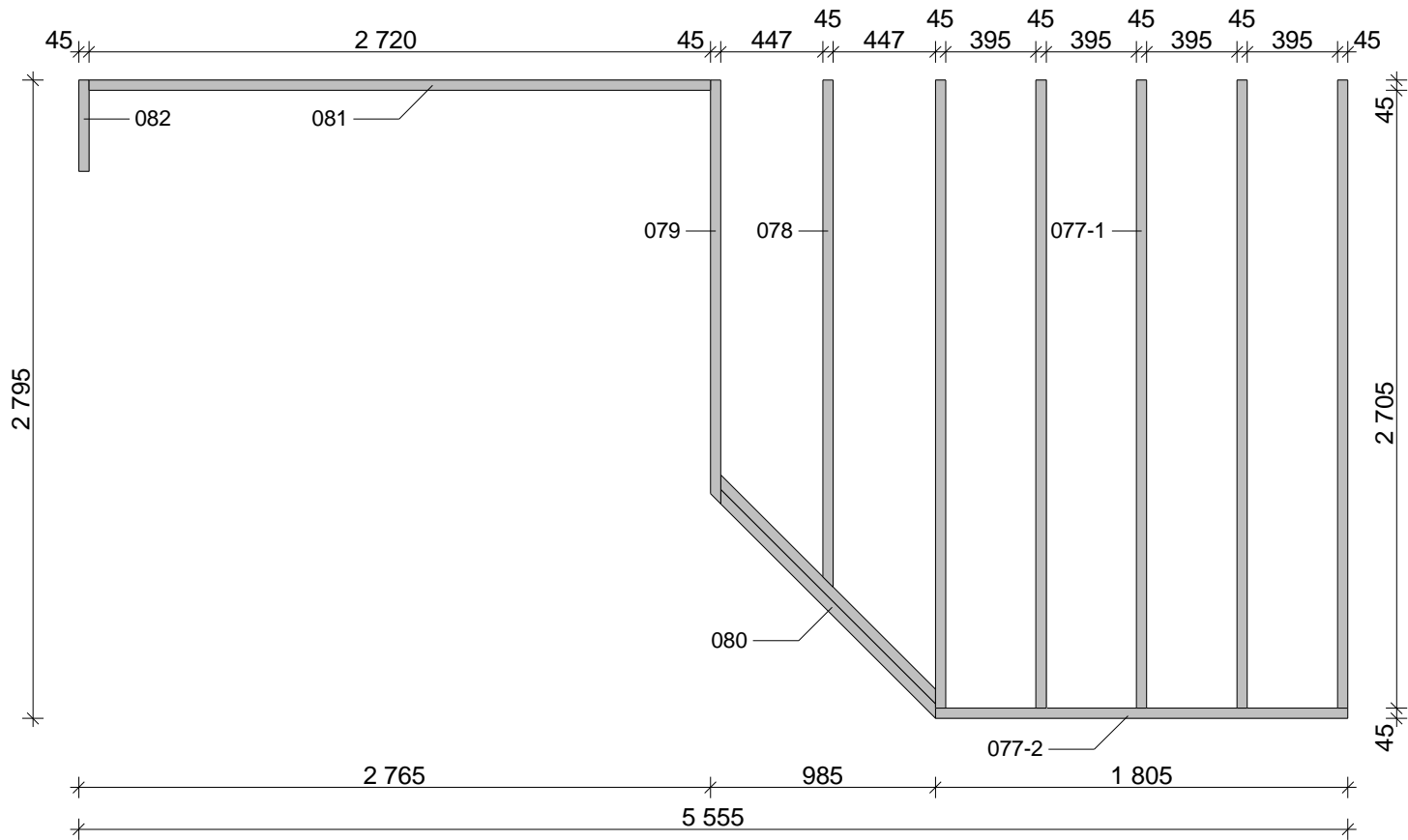

Wandplan Catania 40 mm - 576 x 300 cm - Wandplan

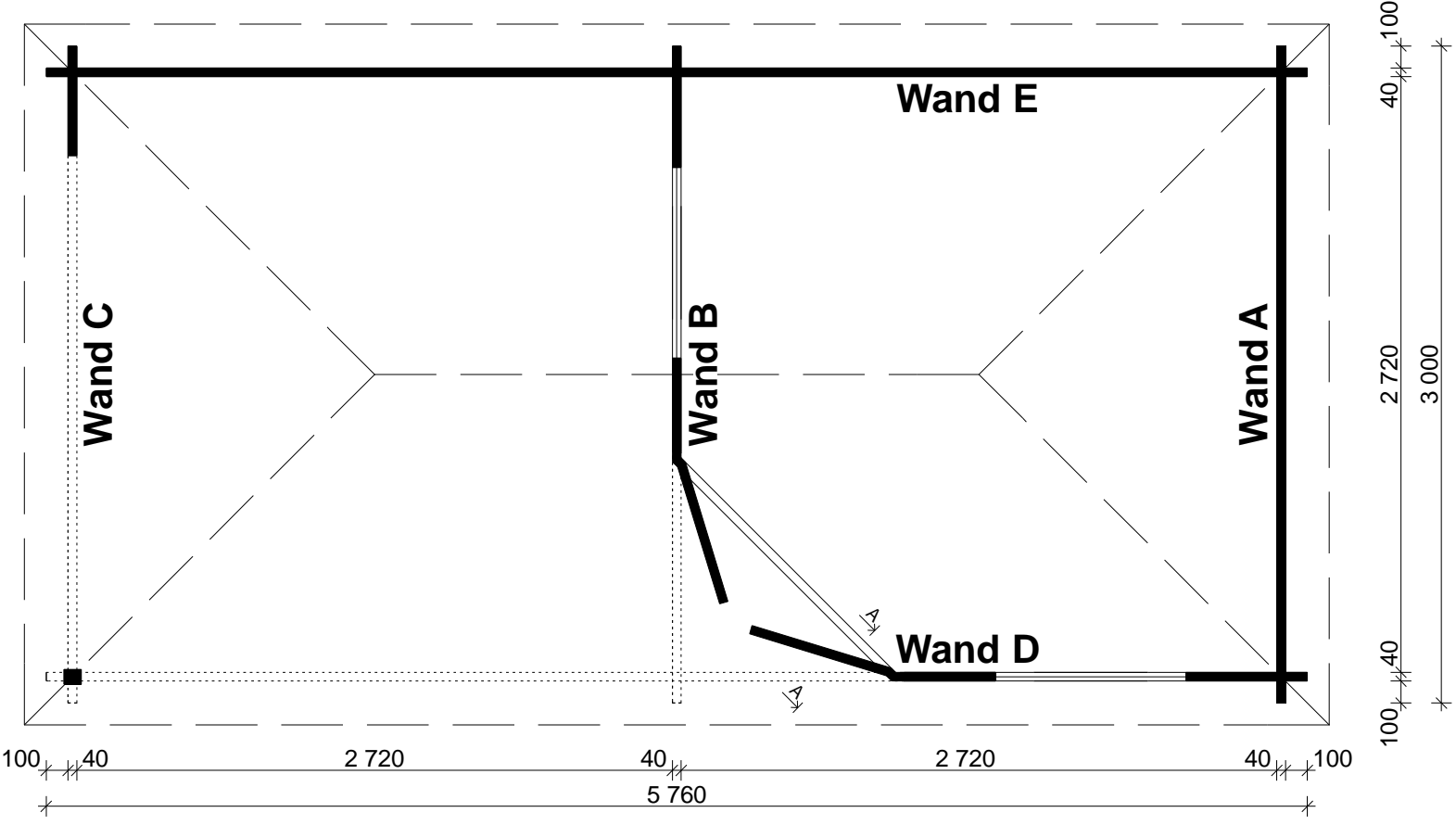

Wandplan Catania - 576 x 300 cm

Wand A

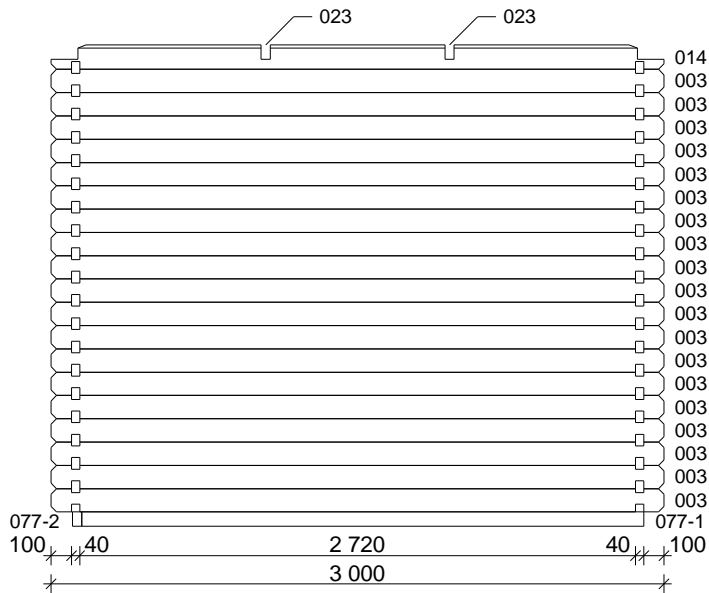

Wand B

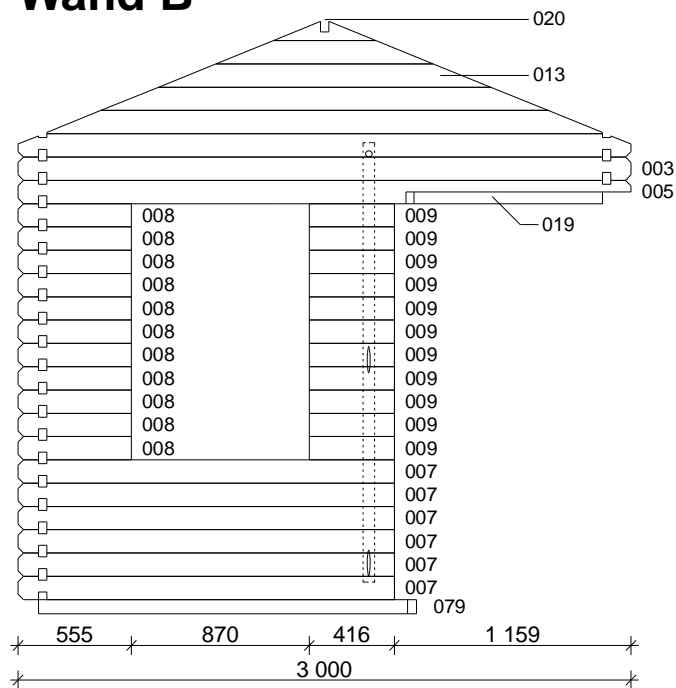

Wandplan Catania - 576 x 300 cm

Wand C

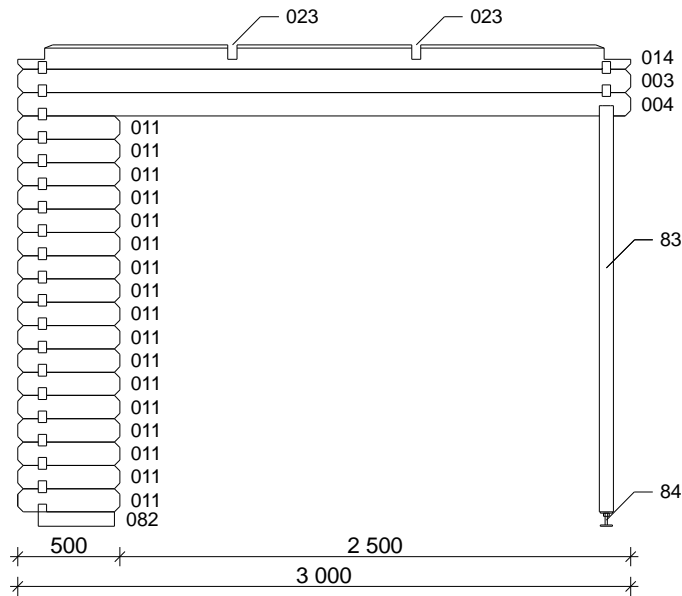

Nr. 27

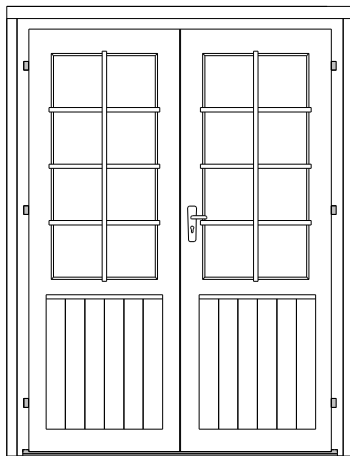

Doppeltür 40 mm
1425 x 1900 mm
1 stk.

Nr. 28

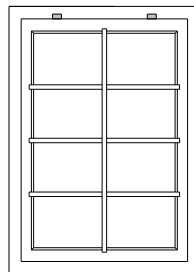

Fenster 40 mm
865 x 1210 mm
2 stk.

A - A

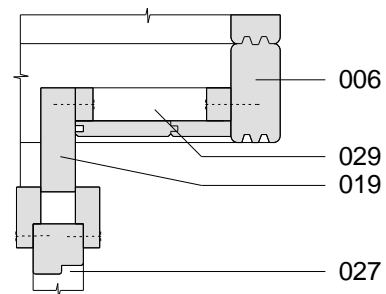

Wandplan Catania 40 mm - 576 x 300 cm - Dachplan

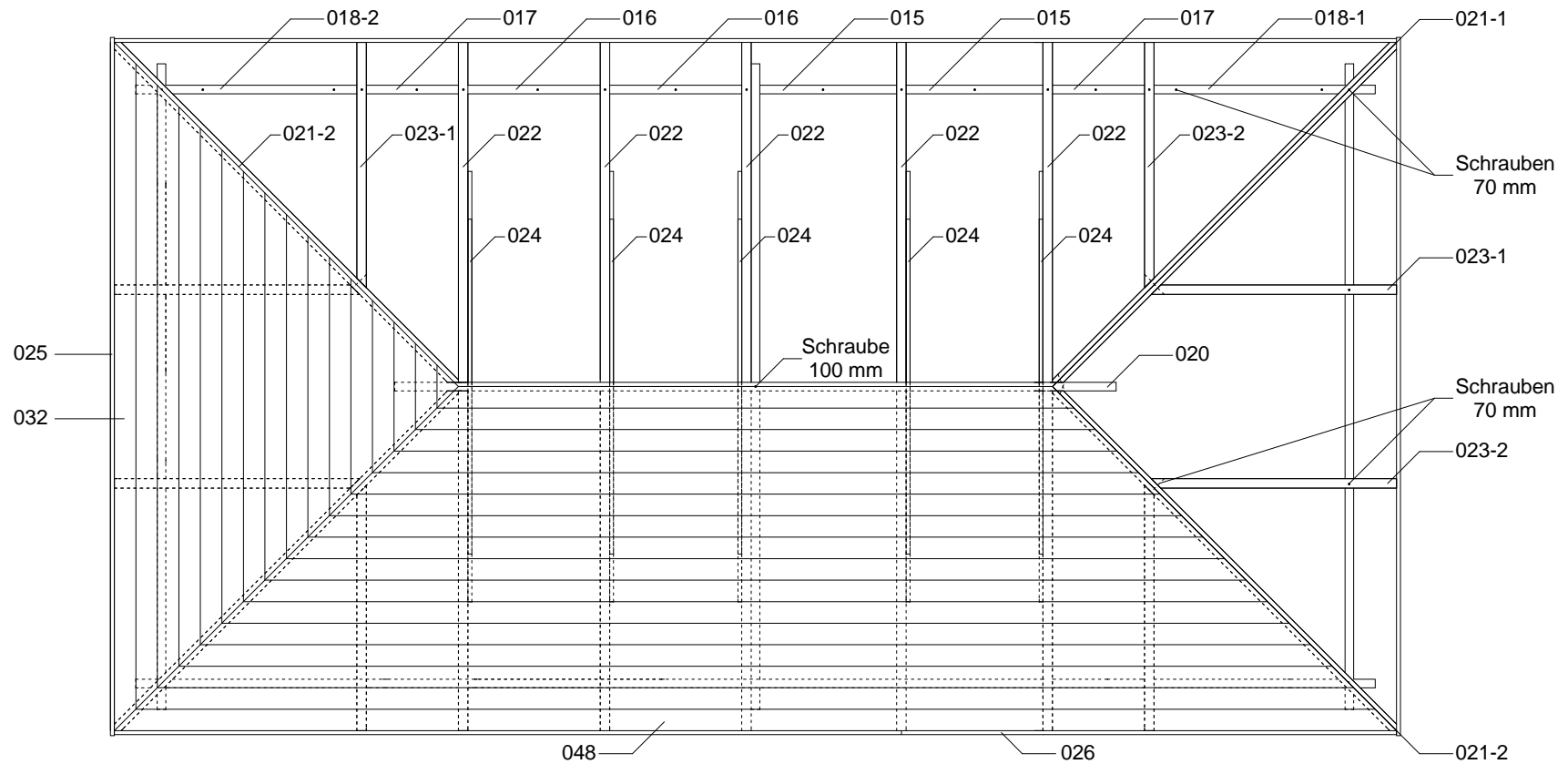

Doppeltür (Wand 40 mm)

Nr	Beschreibung	Profil mm	Stück
1	Rahmen profil Links + Rechts	99 x 82	1+1
2	Rahmen profil Oberteil	58 x 58	1
3	Türschwelle	28 x 58	1
4	Wechselrahmen	28 x 55	2
5			2
6		28 x 70	1
7			1
8			2(1+1)
9			2(1+1)
10	Edwelstahlbedeckung für Türschwelle		1

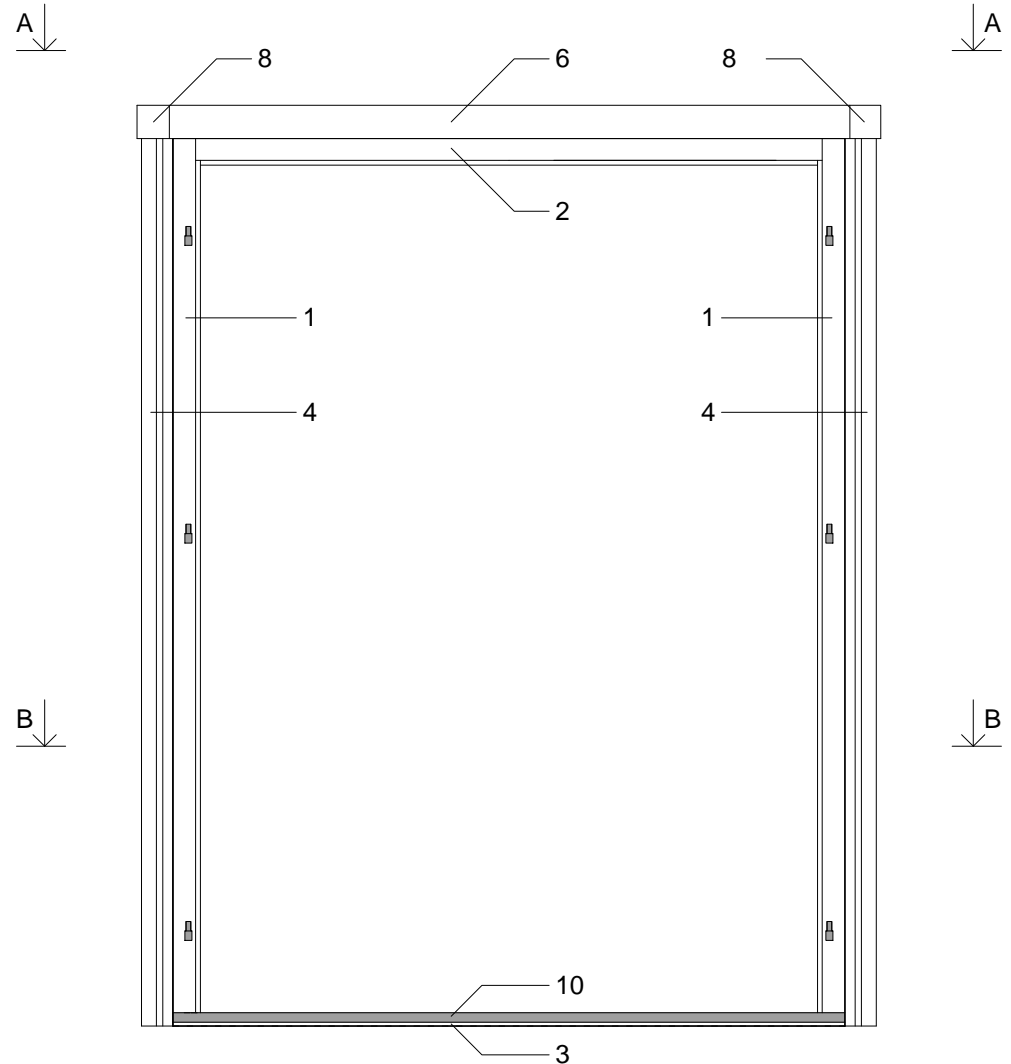

A-A

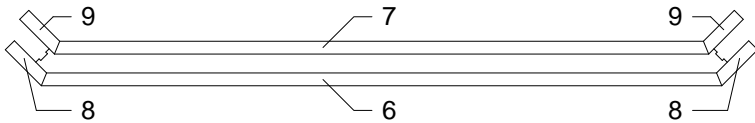

B-B

