

# Techn. Daten: Enzo C/1

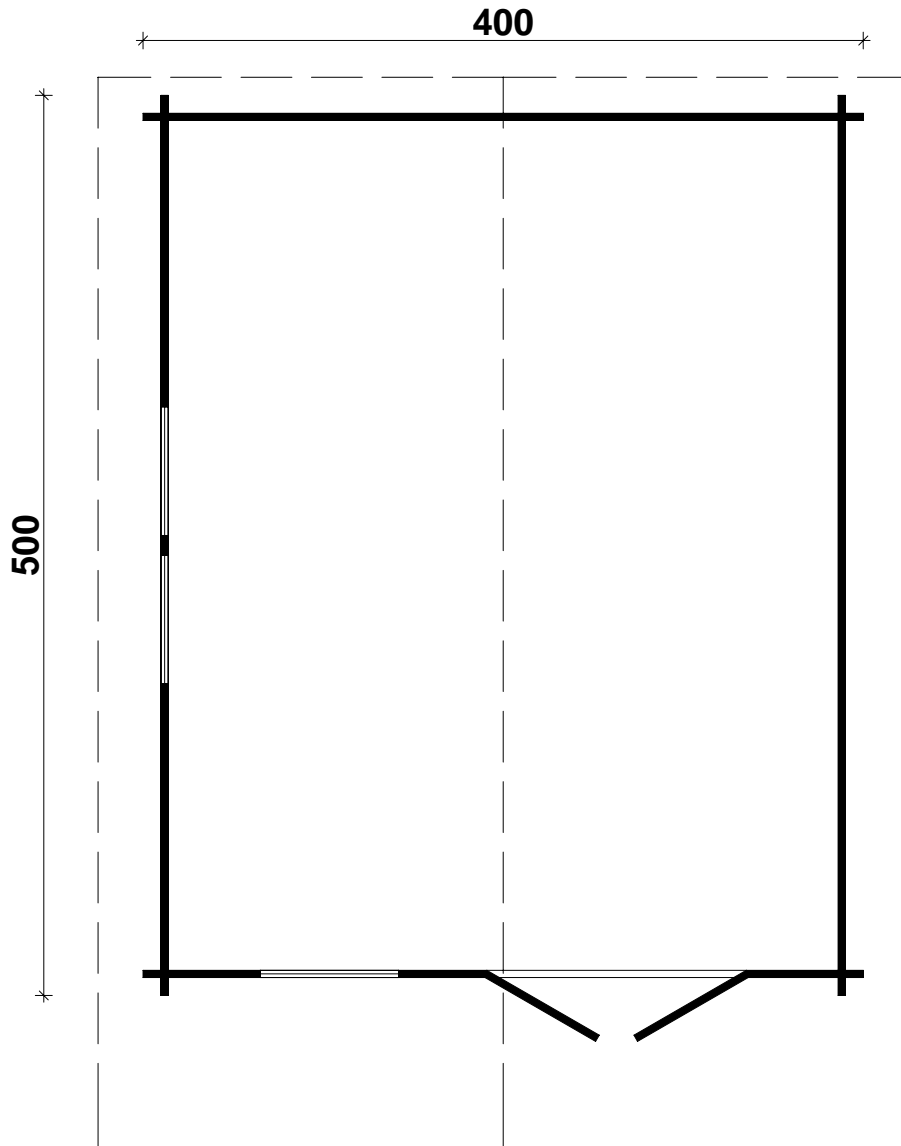











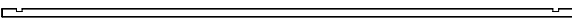
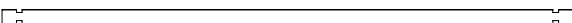
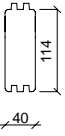





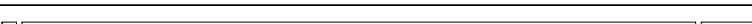
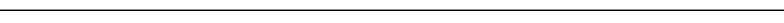
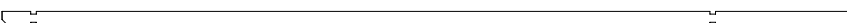



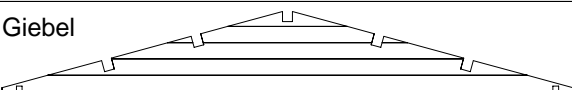

Bohlenaußenmaß (B x T): 400 x 500 cm

Wandaußenmaß: 380 x 480 cm · Bohlenstärke: 40 mm

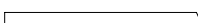

Achtung : Alle angegebenen Maße sind ca. - Maße !

# Teilleiste Enzo C/1 40

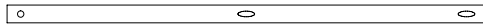
Nr.	Beschreibung	Profil mm	Länge mm	Stück	
001-1	Fundamenthölzer		3790	2	
001-2			4650	7	
002-1			1910/650	1/1	
002-2			4000	1	
003			4000	17	
004			5000	22	
005			650	26	
006			1910	8	
007			1730	17	
008			490	9	
009			--	--	
010			--	--	
011			2030	1	
012			--	--	
013			--	--	
014			5300	1	
015			5575	2	
016	Abgeschrägte Vordachbohle 			5950	2(1+1)
017	Dachbalken 			5950	5(4+1)
018	Giebel 		4000	2	
019	Doppeltür ca. 1425 x 1955mm - 40 mm + 			1/2	
020	Doppelfenster ca. 1530 x 990mm - 40 mm + 			1/2	
021	Fenster ca. 765 x 990mm - 40 mm + 			1/1	
022	Dachpappe		--	--	
023	Dachbretter		2300	136+2/110+2	
024	Fußbodenbretter		3716	54+1/43+1	
025	Giebelblende 		--	--	
026	Giebelblende 		2340	4	
027	Giebelabschlussbrett		2340	4	
028	Traufenbrett		5950	2	
029	Traufenleiste		2975	4	
030	Raute			2	
031	Fußleisten		ca. 16,9 m		
032	Sturmleisten 		2010	4	
033	Schrauben 4,0 x 40; 4,0 x 50; 5,0 x 70; 6,0 x 140			120/1000/15/60	

# Teileliste Enzo C/1 40

Nr.	Beschreibung	Profil mm	Länge mm	Stück
034	Nägel 1,4 x 35			50
035	Dachpappnägel 3,0 x 15			--
036	Schloßschrauben M 8 x 70, Mutter, Scheibe			12
037	Schlaghölzer		300-400	

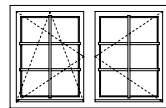

NR. 020  
Doppelfenster 40 mm  
1530 x 990 mm  
1 st.

+2  
stk

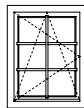

NR. 021  
Einzelfenster 40 mm  
765 x 990 mm  
1 st.

+1  
stk

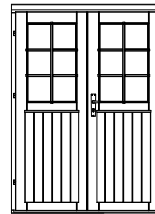

NR. 019  
Doppeltür 40 mm  
1425 x 1955 mm  
1 st.

+2  
stk

## Fundamentplan

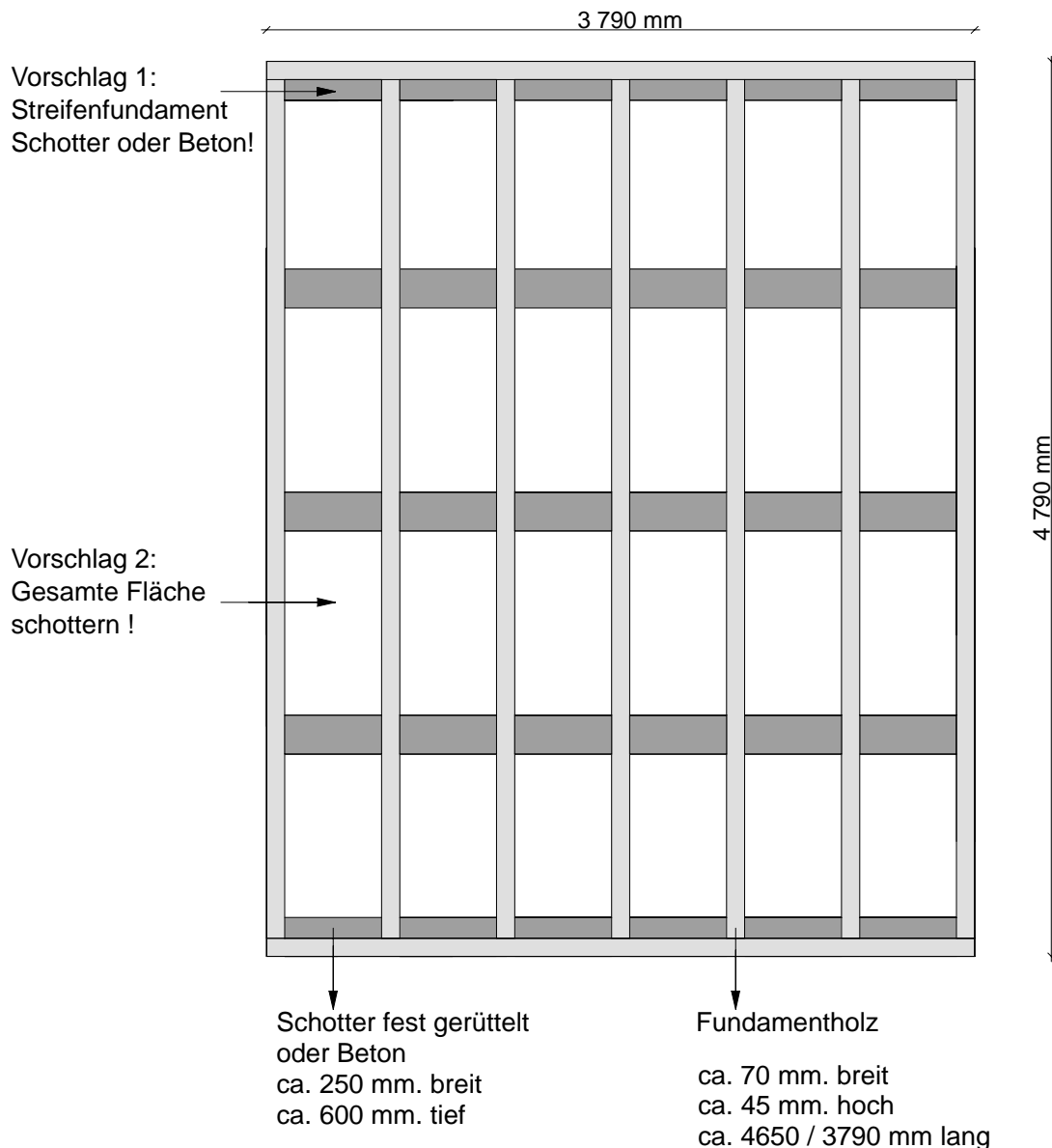

Haustyp	Anzahl der Fundamenthölzer
Enzo C/1 40	2(ca. 70x45x3790 mm)
	7(ca. 70x45x4650 mm)

# Wandplan Enzo C/1 40

## Wand A

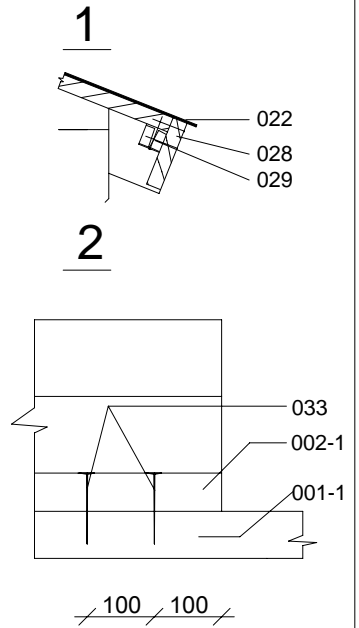
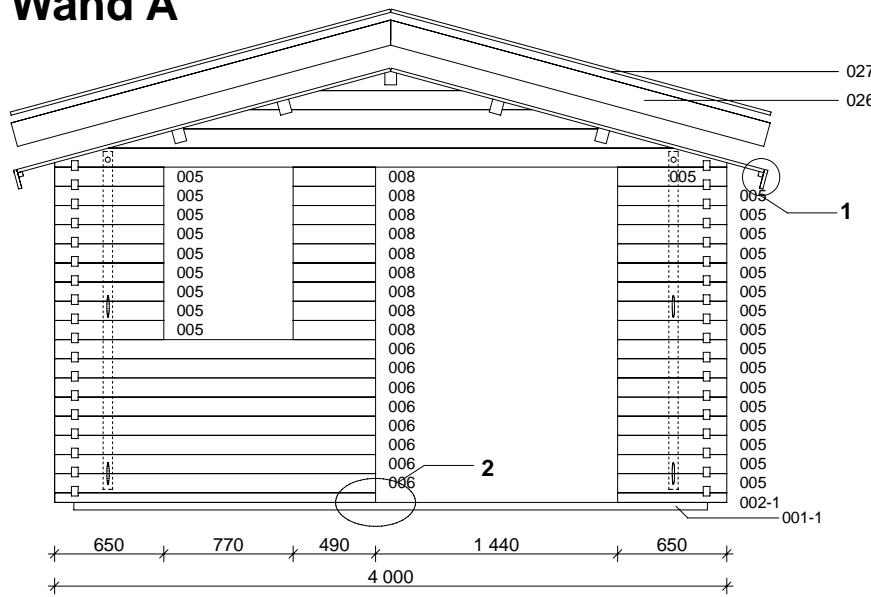

## Wand B

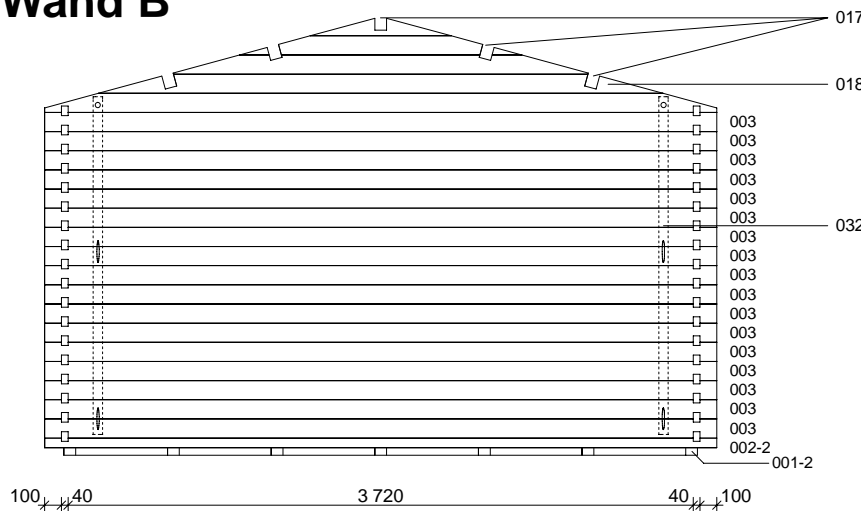

### A-A

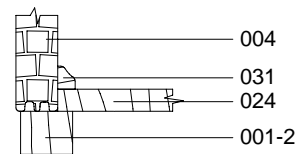

### B-B

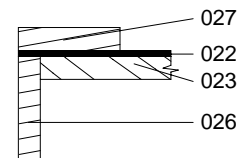

## Wand C

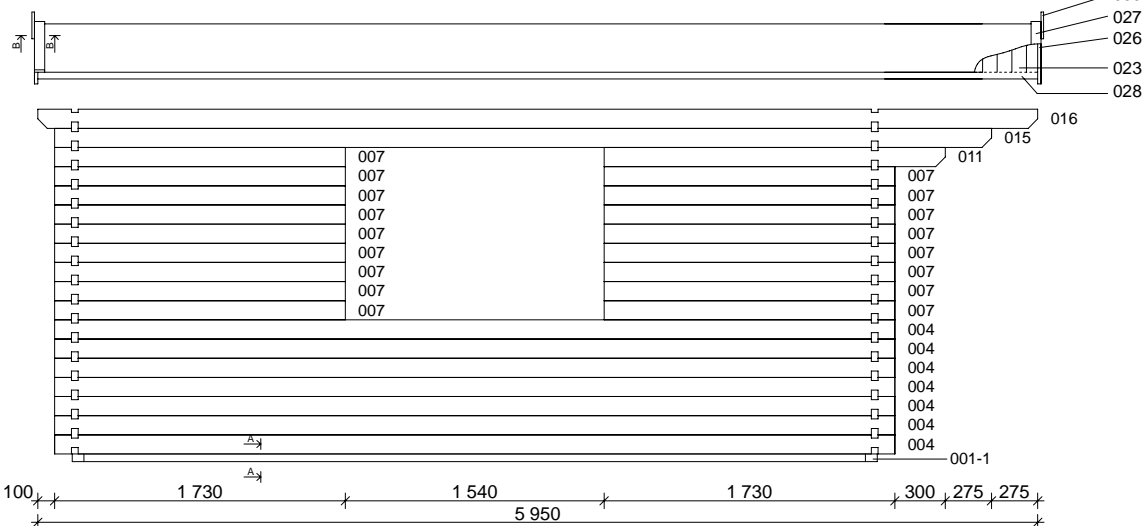

# Wandplan Enzo C/1 40

## Wand D

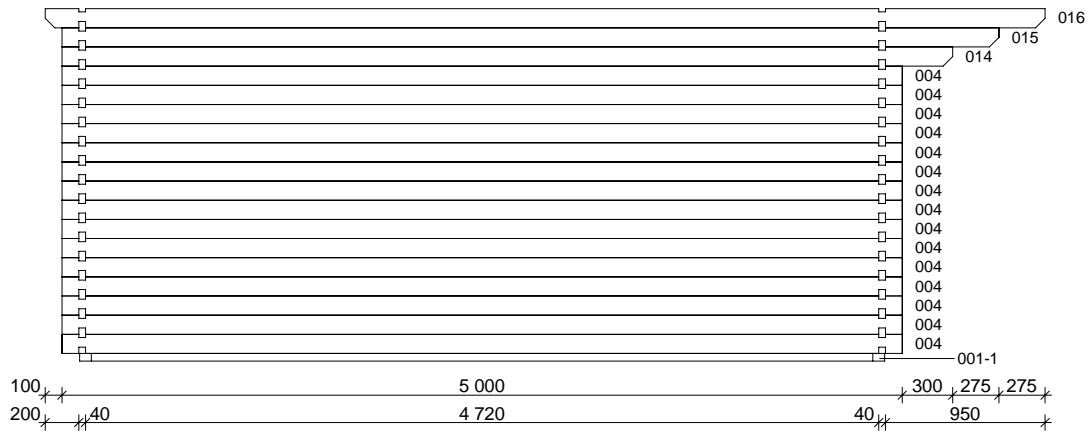

## Wandplan

