

Techn. Data: Karina

Log length (W x D): 255 x 435 cm

Wall size(outside): 235 x 415 cm · Log thickness: 40 mm

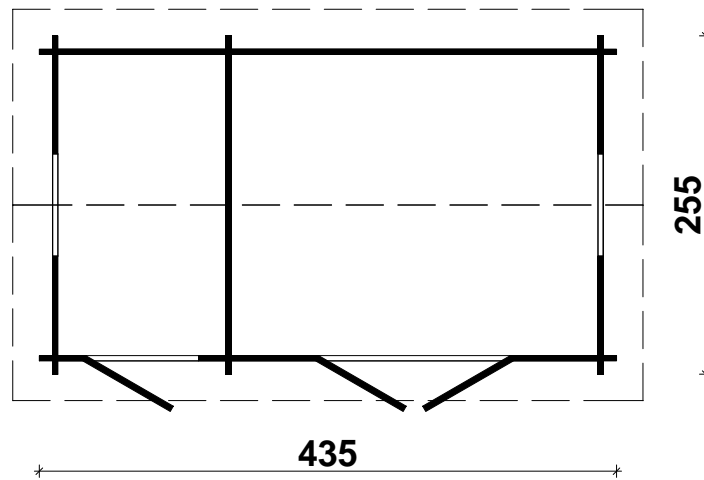

Note: All dimensions are approximate !

Karina 40 mm / 255 x 435 cm

Ground plan

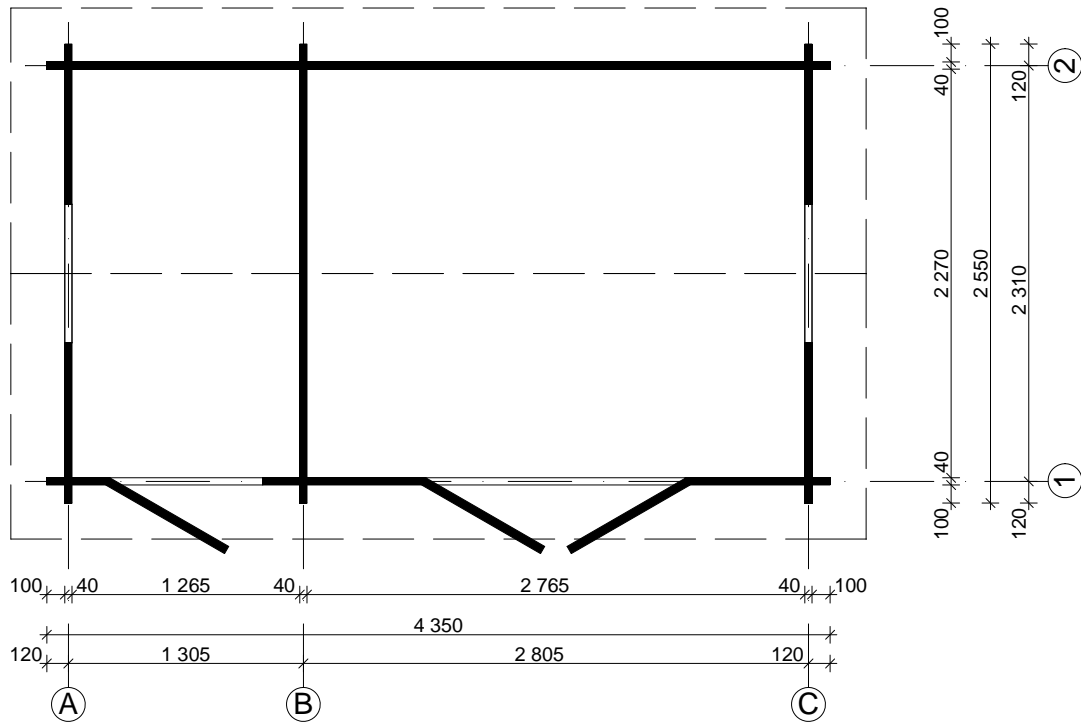

Foundation beams

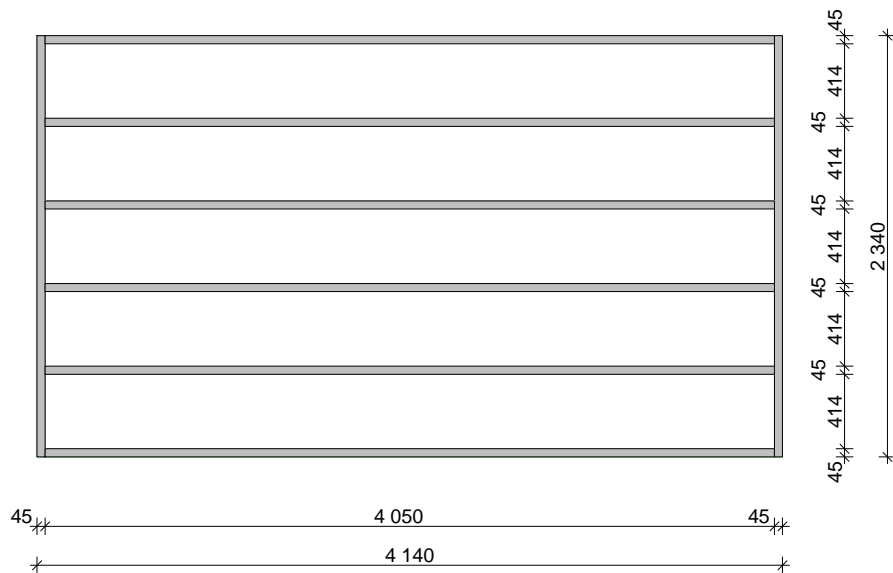

Karina 40 mm / 255 x 435 cm

1

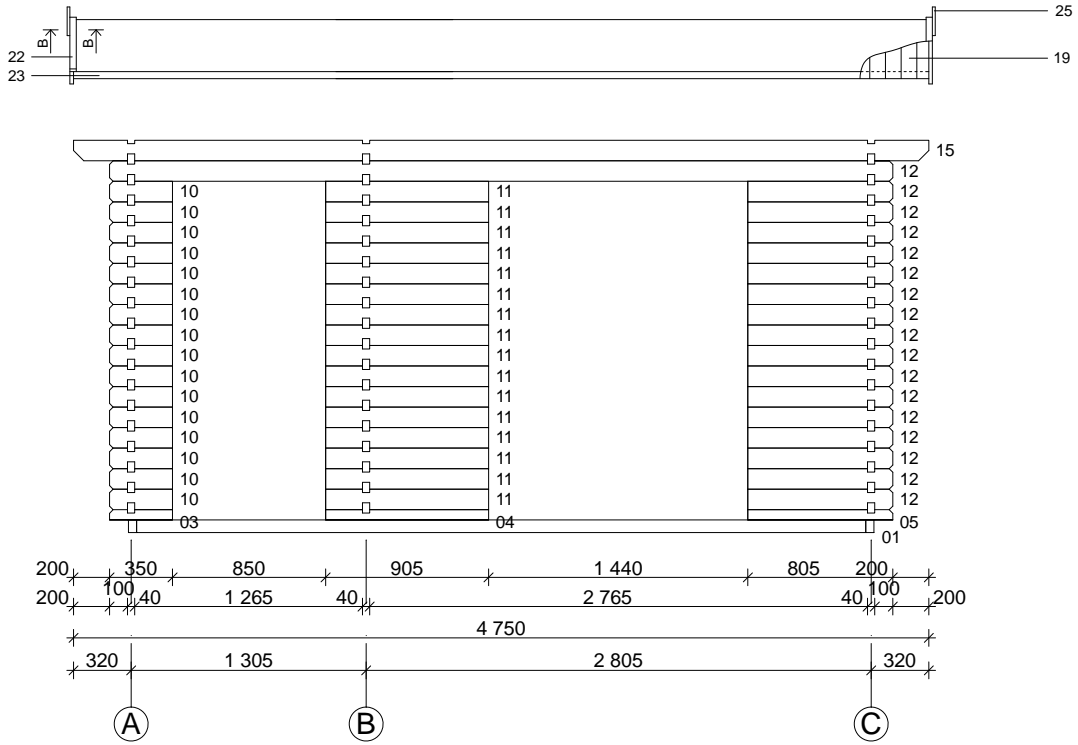

2

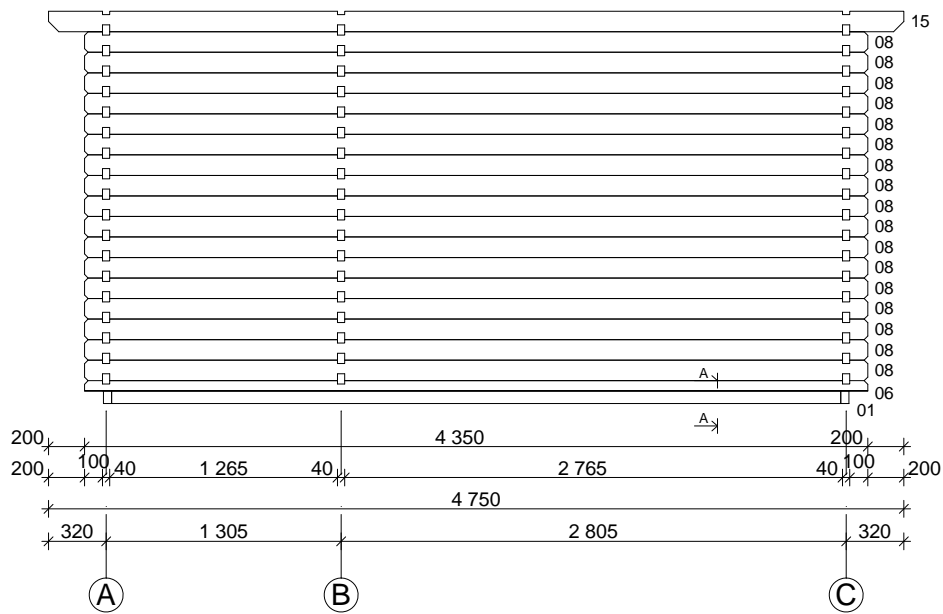

Karina 40 mm / 255 x 435 cm

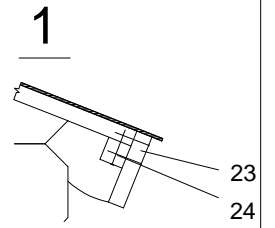
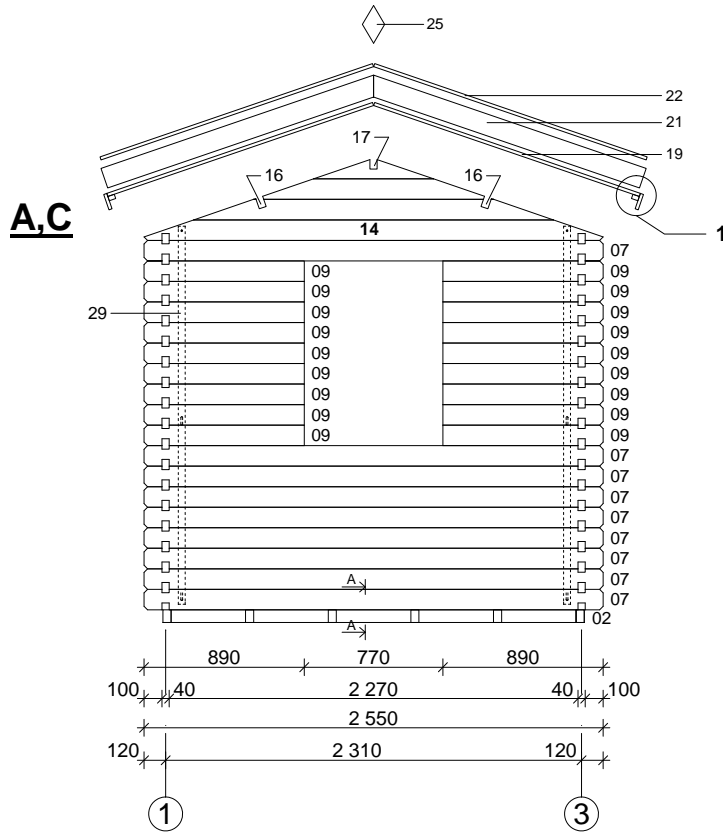



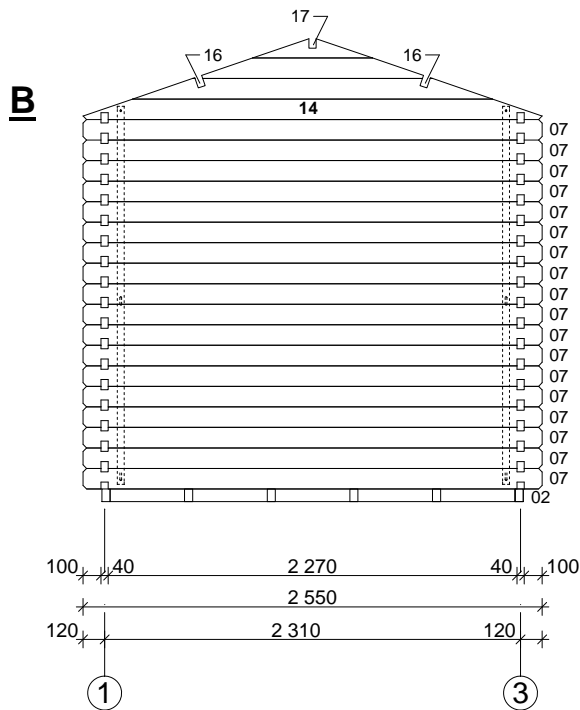
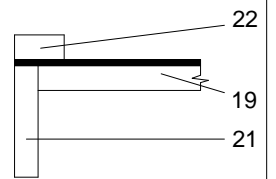



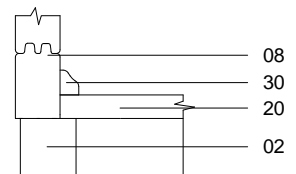







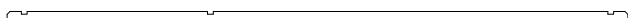

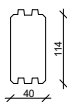

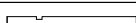
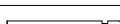
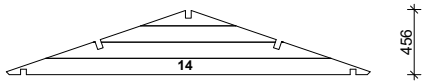

B-B

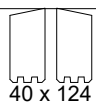

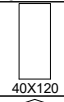
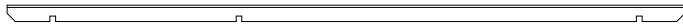
A-A



Specification - Karina 40 mm / 255 x 435 cm

Nr	Description	Profile mm	Length mm	Quantity
1	Foundation 	45x70	2340	2
2			4050	6
3			350	1
4			905	1
5			805	1
6			4350	1
7			2550	36
8			4350	18
9			890	36
10			350	16
11			905	16
12			805	16
13			--	--
14			2550	3
15			4750	2(1+1)
16			4750	2
17			4750	1
18	Roofing felt		--	--
19	Roof board	Vers. 1 >		--
		or in Vers. 2 >		1560
20	Floor board		2266	37+1
21	Facia board 	18x115	1600	4
22	Eave edging	16x35	1600	4
23	Roof edge reinforcement	18x90	4750	2
24	Roof edge reinforcement	28x28	2375	4
25	Diamond 			2
26	Screws 4,0 x 40 ; 4,0 x 50 ; 5,0 x 70 ; 6,0 x 140			120/600/15/55
27	Nails 1,4 x 35			50
28	Roofing nails 3,0 x 15			--

