

Date rev. Description V 1.0

House	4475508 Benno 44 mirror	Sheet	1
-------	-------------------------	-------	---

Drawing	3D	Scale	
---------	----	-------	--

Material	44x135	Date	19.01.2024
----------	--------	------	------------

Drawer	K.K.	File	4475508 Benno 44 mirror 3D.dwg
--------	------	------	--------------------------------

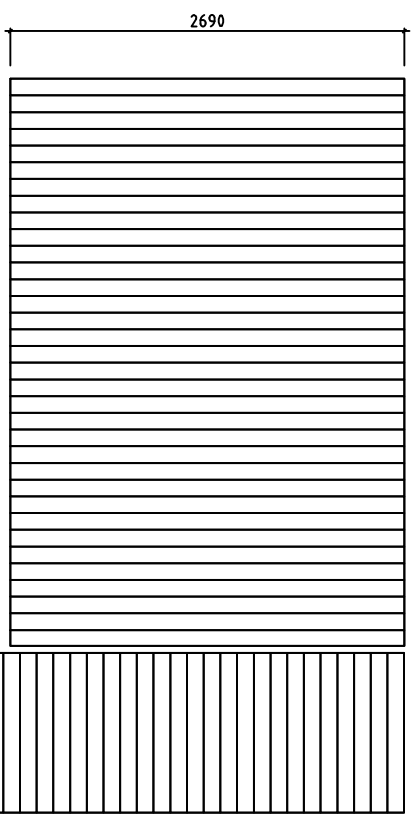
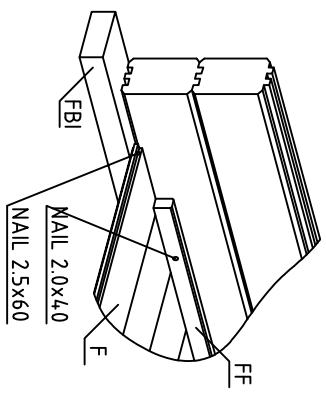
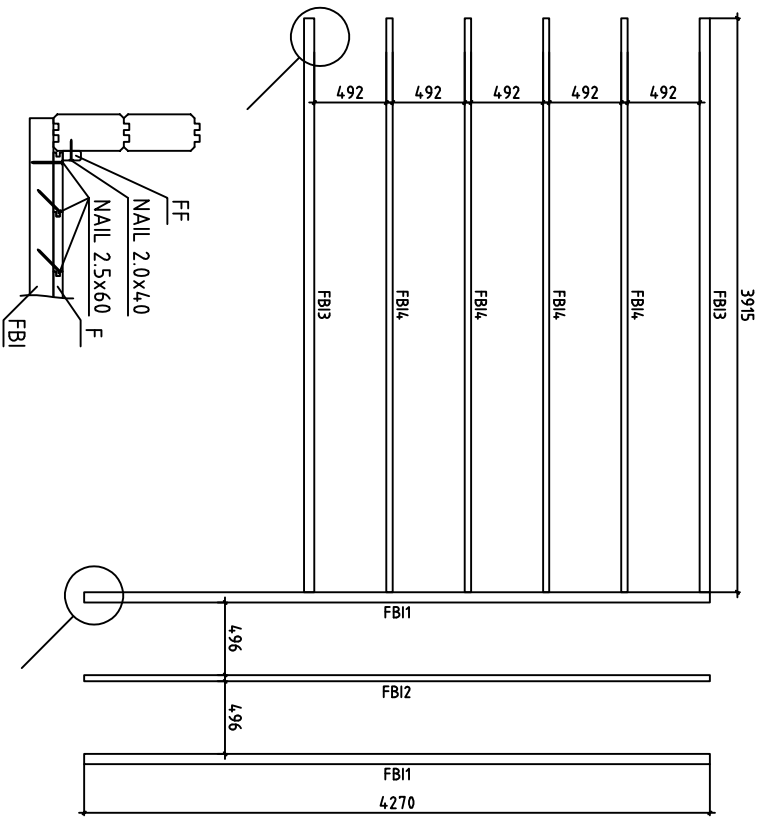

House	44.75508 Benno 44 mirror	Sheet	2
Drawing		Scale	1:50
Material	70x43, 43x43	Date	19.01.2024
Drawer	K.K.	File	44.75508 Benno 44 mirror.dwg

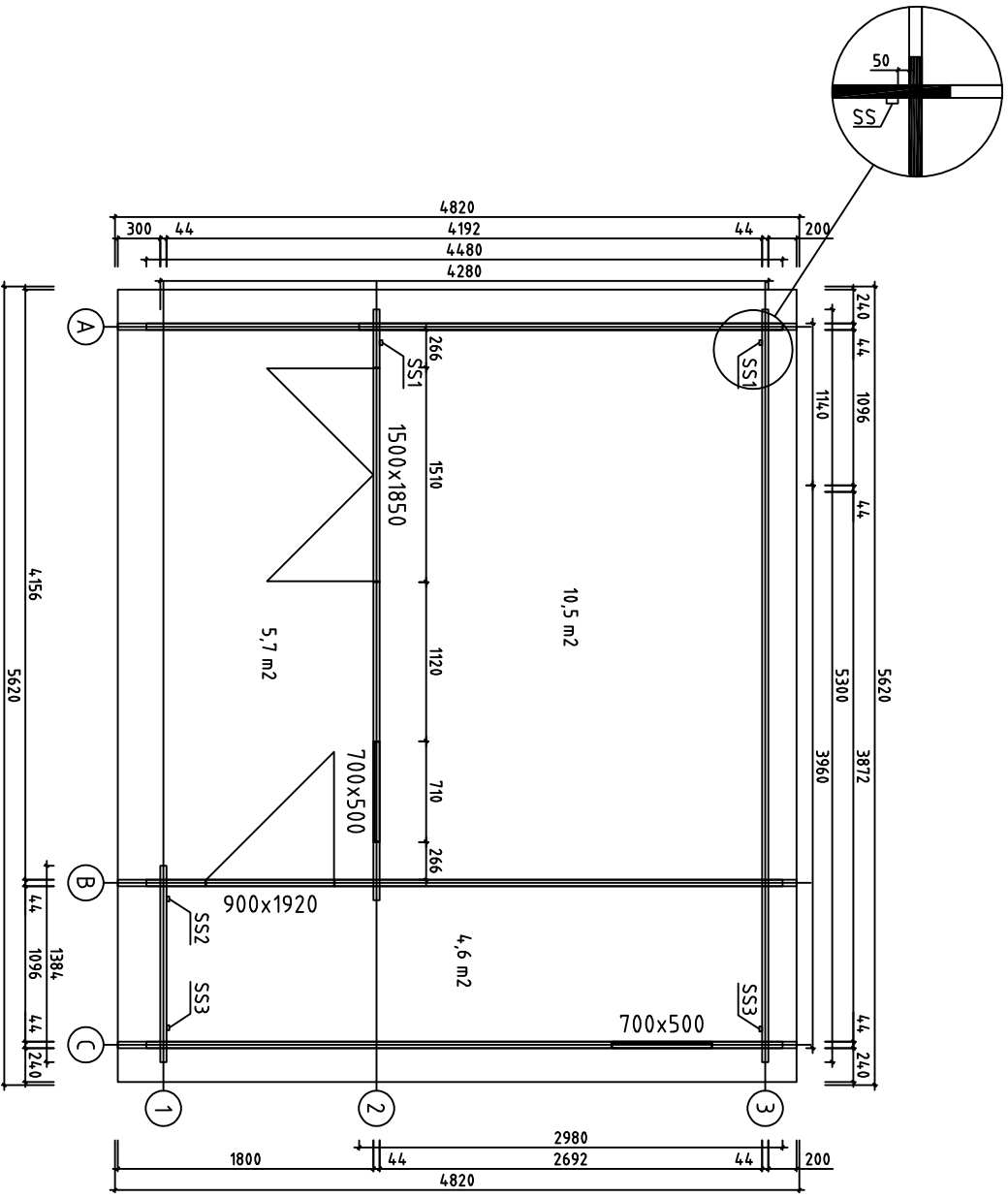

House	44.75508 Benno 44 mirror	Sheet	3
Drawing	GRUNDPLAN-GRUNDPLAN-PLAN	Scale	1:50
Material	44x135	Date	19.01.2024
Drawer	K.K.	File	44.75508 Benno 44 mirror.dwg

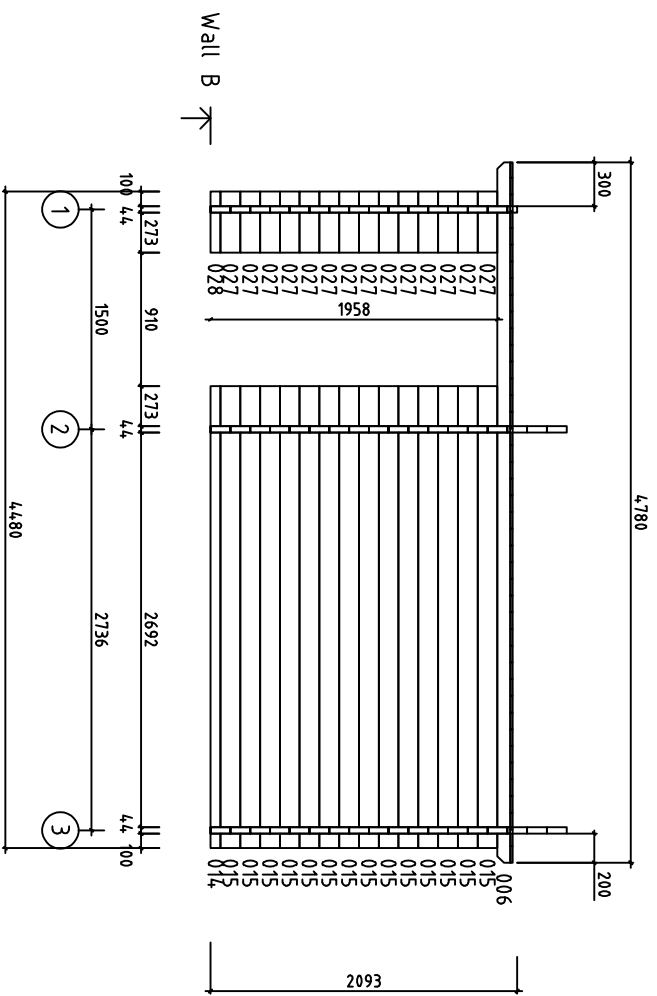

House	4475508 Benno 44 mirror	Sheet	5
Drawing	WALL B	Scale	1:50
Material	44x135	Date	19.01.2024
Drawer	K.K.	File	4475508 Benno 44 mirror.dwg

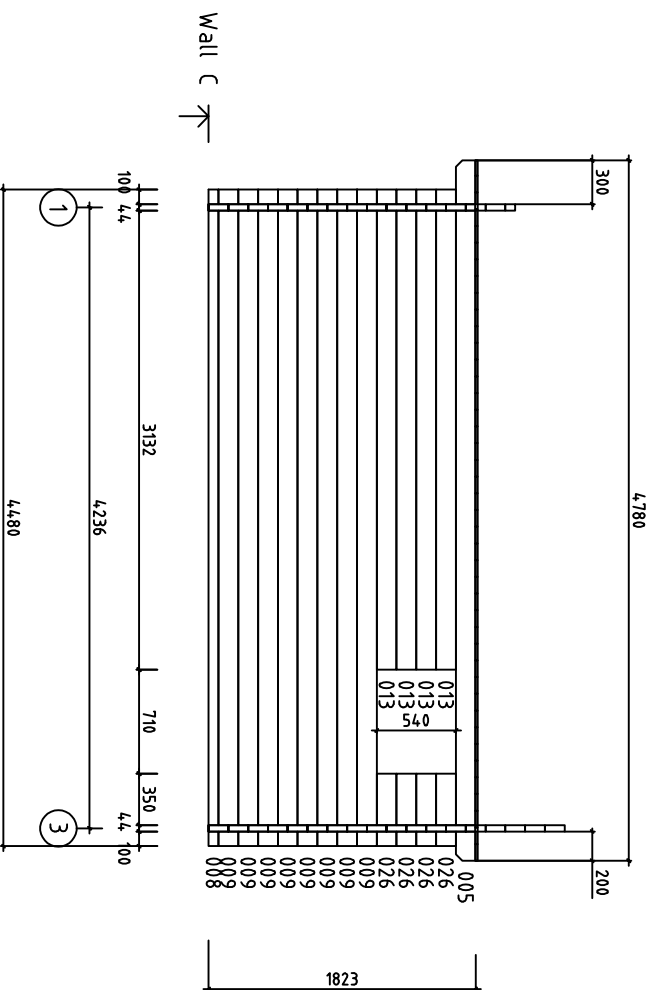

House	4475508 Benno 44 mirror	Sheet	6
Drawing	WALL C	Scale	1:50
Material	44x135	Date	19.01.2024
Drawer	K.K.	File	4475508 Benno 44 mirror.dwg

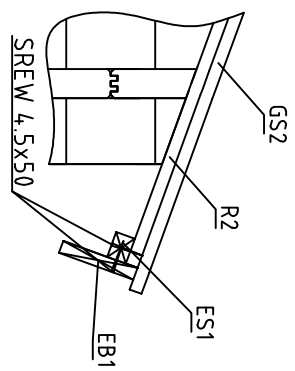
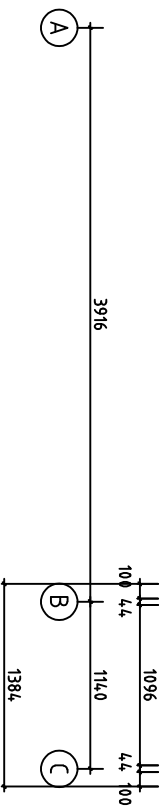
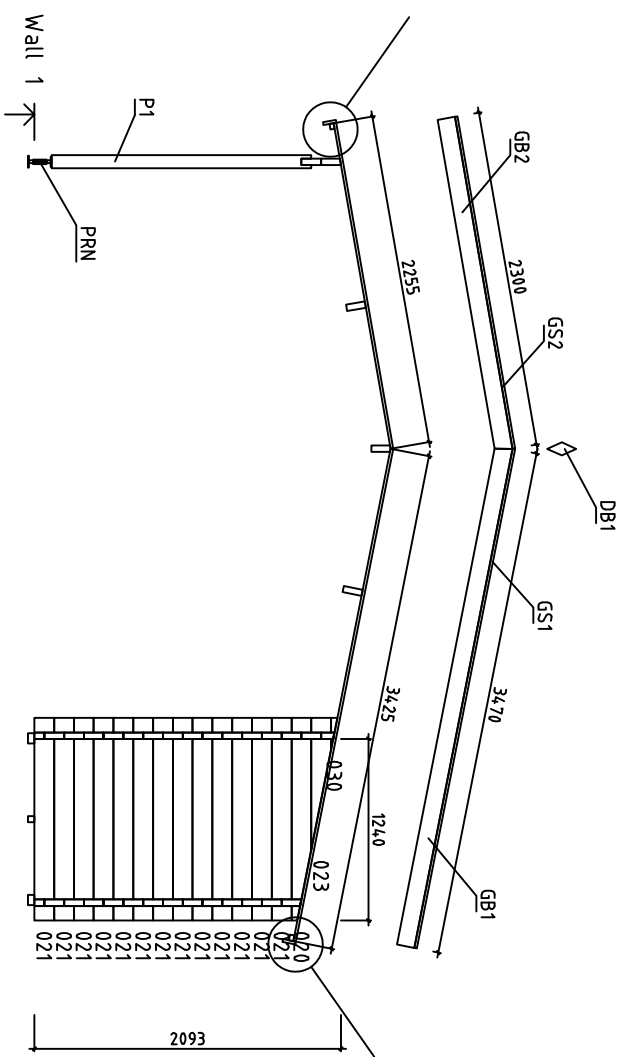
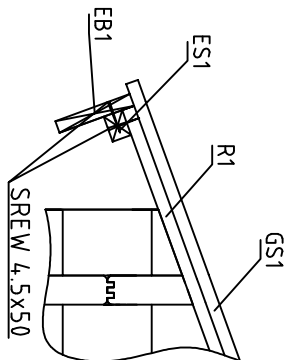

House	4475508 Benno 44 mirror	Sheet	7
Drawing	WALL 1	Scale	1:50
Material	44x135	Date	19.01.2024
Drawer	K.K.	File	4475508 Benno 44 mirror.dwg

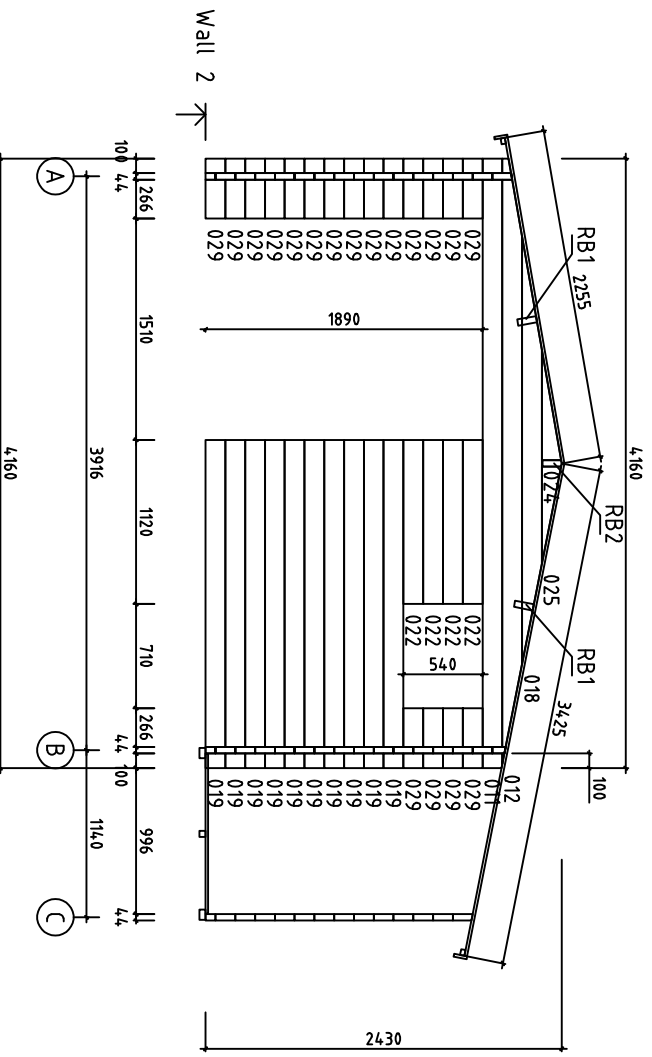



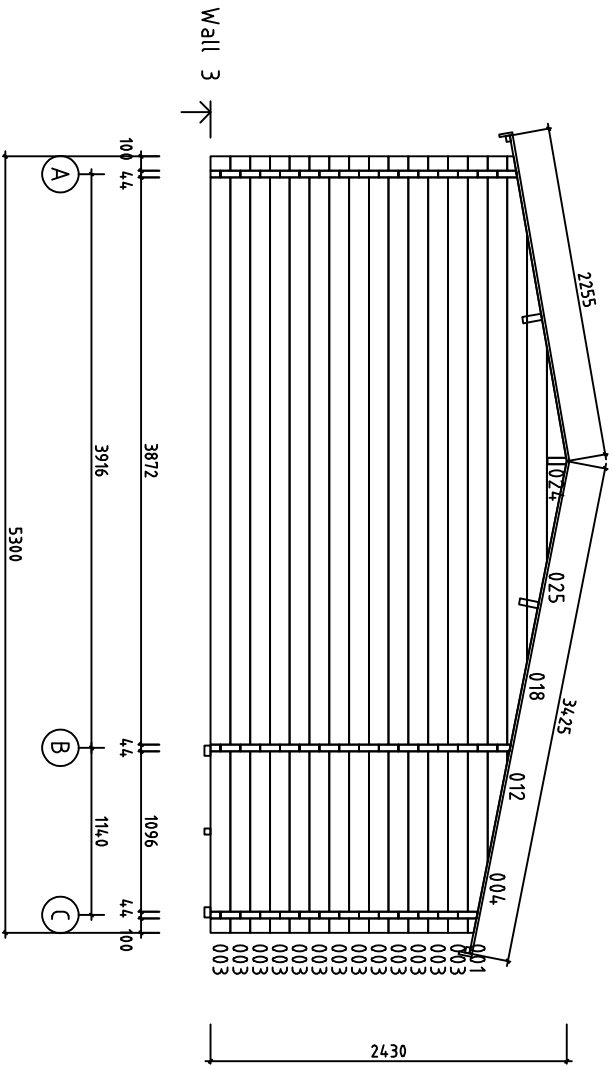











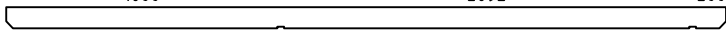
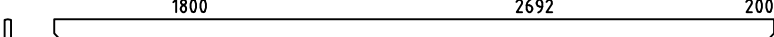





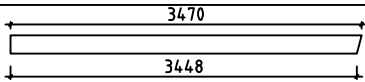
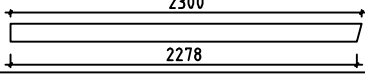















House	4475508 Benno 44 mirror	Sheet	8
Drawing	WALL 2	Scale	1:50
Material	44x135	Date	19.01.2024
Drawer	K.K.	File	4475508 Benno 44 mirror.dwg

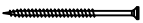
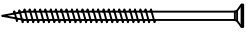
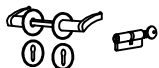
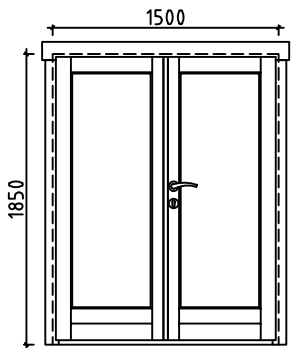

House	4475508 Benno 44 mirror	Sheet	9
Drawing	WALL 3	Scale	1:50
Material	44x135	Date	19.01.2024
Drawer	K.K.	File	4475508 Benno 44 mirror.dwg

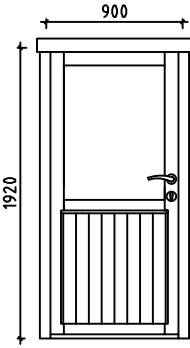
Pos	4475508 Benno 44 mirror	Pcs.	Profil (mm)	L (mm)
002		1	44x135	5300
003		13	44x135	5300
005		1	44x135	4780
006		1	44x90	4780
007		1	44x135	4780
008		1	44x68	4480
009		8	44x135	4480
010		1	44x135	4480
013		4	44x135	3276
014		1	44x68	3153
015		14	44x135	3153
016		1	44x68	2980
017		13	44x135	2980
019		10	44x135	2240
021		13	44x135	1384
022		4	44x135	1120
026		4	44x135	494
027		14	44x135	417
028		1	44x68	417
029		18	44x135	410
W1-1		1	44x312	1384
W2-1		1	44x536	4160
W3-1		1	44x671	5300

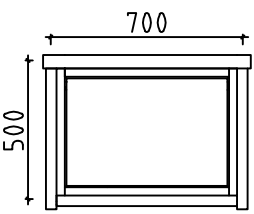
Pos	4475508 Benno 44 mirror		Pcs.	Profil (mm)	L (mm)
HB	HIT BLOCK-SCHLAGHÖLZER-BLAZENPLANK		2	44x135	300
FBI1	FLOORBEAMS-FUSSBODENBALKEN-VLOERBALKEN	 IMM	2	70x43	4270
FBI3	FLOORBEAMS-FUSSBODENBALKEN-VLOERBALKEN	 IMM	2	70x43	3916
FBI2	FLOORBEAMS-FUSSBODENBALKEN-VLOERBALKEN	 IMM	1	43x43	4270
FBI4	FLOORBEAMS-FUSSBODENBALKEN-VLOERBALKEN	 IMM	4	43x43	3916
P1	POST-PFOSTEN-STUT		1	90x90	1790
RB1	ROOFBEAMS-DACHBALKEN-DAKBALK	 1800 2692 200	2	43x140	4780
RB2	ROOFBEAMS-DACHBALKEN-DAKBALK	 1800 2692 200	1	43x140	4780
F1	FLOORBOARD-FUSSBODENBRETT-VLOERPLANK	 or-oder-of	34+1 45+1	18x114 18x88	2690
F2	FLOORBOARD-FUSSBODENBRETT-VLOERPLANK	 or-oder-of	37+1 48+1	18x114 18x88	1090
R1	ROOFBOARD-DACHBRETT-DAKPLANK	 or-oder-of	42+1 55+1	18x114 18x88	3425
R2	ROOFBOARD-DACHBRETT-DAKPLANK	 or-oder-of	42+1 55+1	18x114 18x88	2255
FF1	FLOOR FILLET-FUSSBODENLEISTE-VLOERPLINT			18x35	24.5
GB1	GABLE BOARD-GIEBELBLENDE-GEVELPLANK	 3470 3448	2	18x120	3470
GB2	GABLE BOARD-GIEBELBLENDE-GEVELPLANK	 2300 2278	2	18x120	2300
GS1	ROOF FELT FILLET-GIEBELLEISTE-GEVELLIJST		2	18x70	3470
GS2	ROOF FELT FILLET-GIEBELLEISTE-GEVELLIJST		2	18x70	2300
EB1	EAVE BOARD-TRAUFBRETT-AFDEKPLANK		4	18x90	2390
ES1	EAVE SLAT-TRAUFFENLEISTE-AFDEKLIJST		4	30x40	2390
DB1	DIAMOND-RAUTE-DIAMANT		2	18x90	200
SS1	STORM SLAT-STURMLEISTE-STORMLIJST		2	18x35	1990
SS2	STORM SLAT-STURMLEISTE-STORMLIJST		1	18x35	1890
SS3	STORM SLAT-STURMLEISTE-STORMLIJST		2	18x35	1720
	SCREWS-SCHRAUBEN-SCHROEF (FOR-FÜR-VOOR STORM SLAT-STURMLEISTE-STORMLIJST)		15	ø6	50
	WASHER-SCHEIBE-SCHIJF (FOR-FÜR-VOOR STORM SLAT-STURMLEISTE-STORMLIJST)		15	ø6	
House	4475508 Benno 44 mirror	Material	File	4475508 Benno 44 mirror.dwg	Sheet 11

Pos	4475508 Benno 44 mirror	Pcs.	Profil (mm)	L (mm)
PRN	POST REGULATOR-PFOSTEN REGLER- PIED MÉTALLIQUE RÉGLABLE POUR POTEAU		1	
	SCREWS-SCHRAUBEN-VIS FOR-FÜR-POUR PRN		8	ø6.0 45
	NAIL-NAGEL-NAGEL FOR-FÜR-VOOR FF1		62	ø2.0 40
	NAIL-NAGEL-NAGEL FOR-FÜR-VOOR F1, F2, R1, R2		815	ø2.5 60
	SCREWS-SCHRAUBEN-SCHROEF FOR-FÜR-VOOR GB1, GB2, GS1, GB2, EB1, ES1, DB1, P1		80	ø4.5 50
	SCREWS-SCHRAUBEN-SCHROEF FOR-FÜR-VOOR 008, 014, 016, 028		17	ø4.5 90
	SCREWS-SCHRAUBEN-SCHROEF RB1, RB2		10	ø6.0 160
	DOUBLEDOR-DOPPELTÜR-DUBBELE DEUR (right-rechts-rechts) AST_PRE		1	1500 1850
			1	
			6	
	DOOR-TÜR-DEUR 900x1930 (left-links-links) AST_PRE		1	900 1920
			1	
	WINDOW-FENSTER-VENSTER (left-links-links) AST_PRE		2	700 500
			4	
House	4475508 Benno 44 mirror	Material	File	4475508 Benno 44 mirror.dwg
			Sheet	12