

House	Marian 4,4 ISO	Sheet	1
Drawing	3D	Scale	
Material	4,4x135	Date	26.08.2019
Drawer	RP	File	Marian 4,4 ISO 3D.dwg

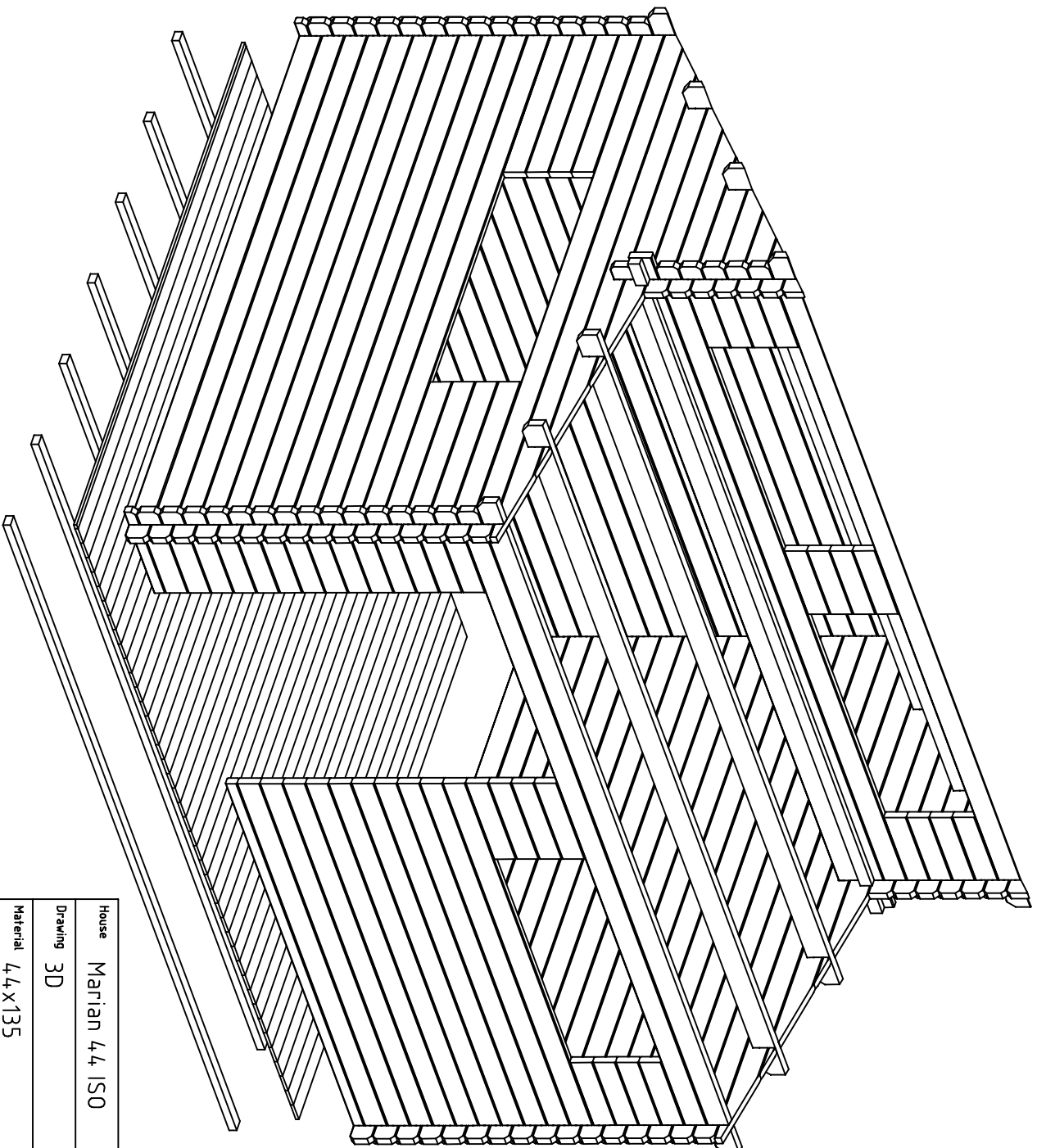

House	Marian 4,4 ISO	Sheet	2
Drawing	3D	Scale	
Material	4,4x135	Date	26.08.2019
Drawer	RP	File	Marian 4,4 ISO 3D.dwg

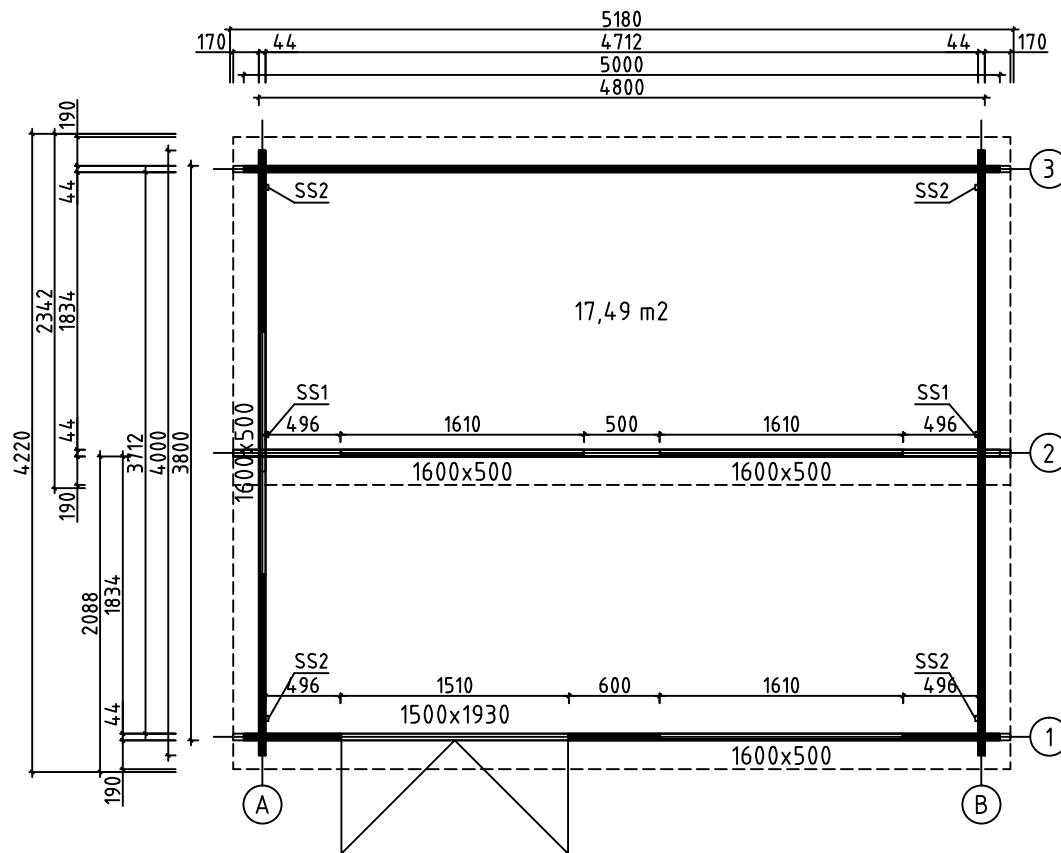

House	Marian 44 ISO	Sheet	3
Drawing	GRUNDPLAN-GRUNDPLAN-PLAN	Scale	1:50
Material	44x135	Date	26.08.2019
Drawer	RP	File	Marian 44 ISO.dwg

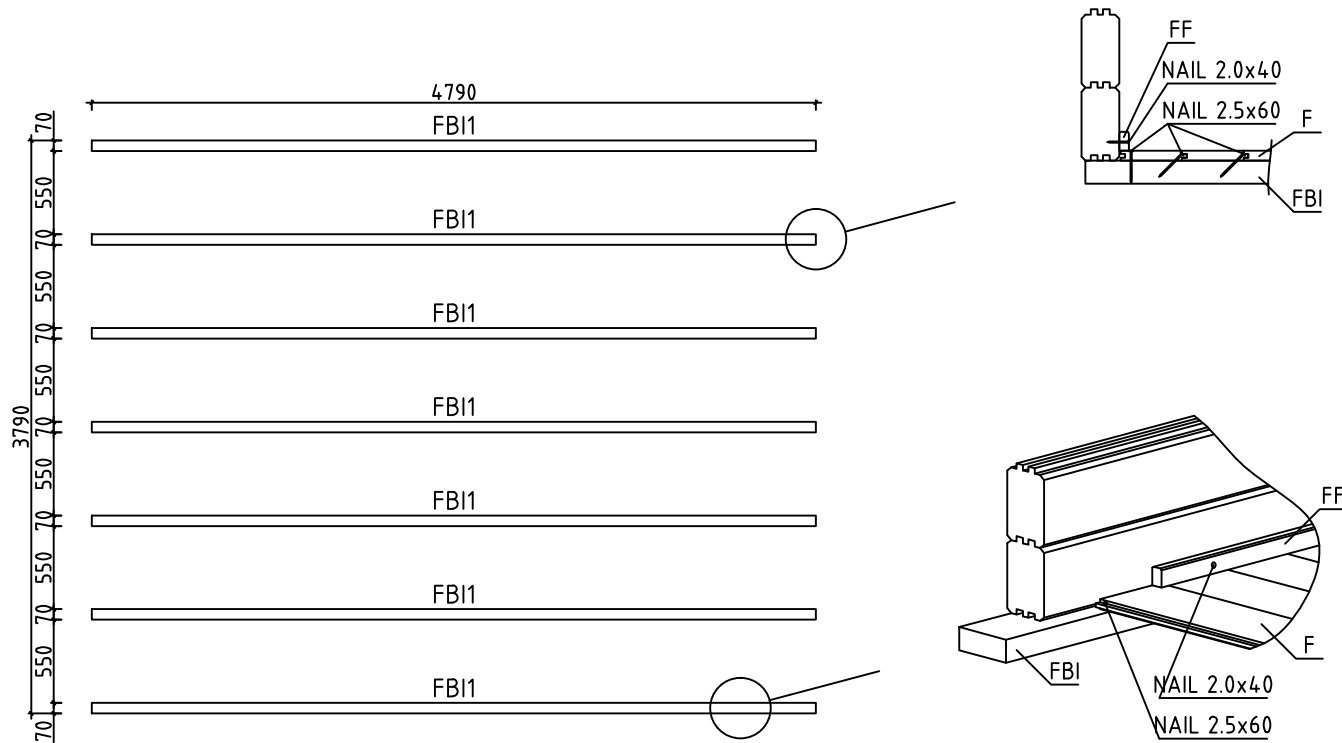

House	Marian 44 ISO	Sheet	4
Drawing	FLOORBEAMS-FUSSBODENBALKEN-VLOERBALKEN	Scale	1:50
Material	70x45	Date	26.08.2019
Drawer	RP	File	Marian 44 ISO.dwg



House	Marian 44 ISO	Sheet	5
Drawing	ROOFBEAMS-DACHBALKEN-DAKBALK	Scale	1:50
Material	43x140, 45x70	Date	26.08.2019
Drawer	RP	File	Marian 44 ISO.dwg

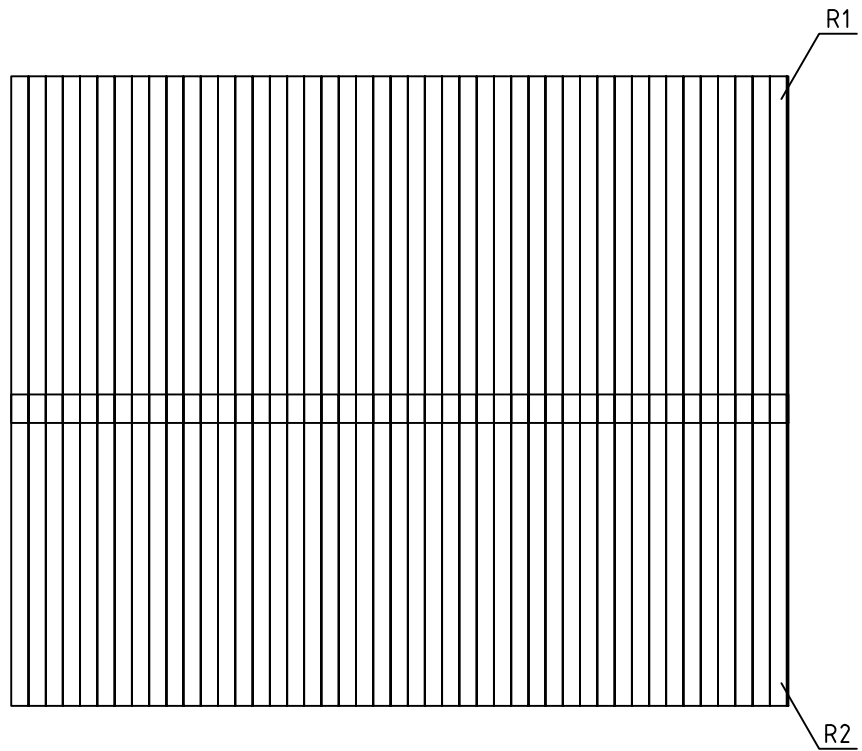

House	Marian 44 ISO	Sheet	6
Drawing	ROOFBOARD-DACHBRETT-DAKPLANK	Scale	1:50
Material	18x114	Date	26.08.2019
Drawer	RP	File	Marian 44 ISO.dwg

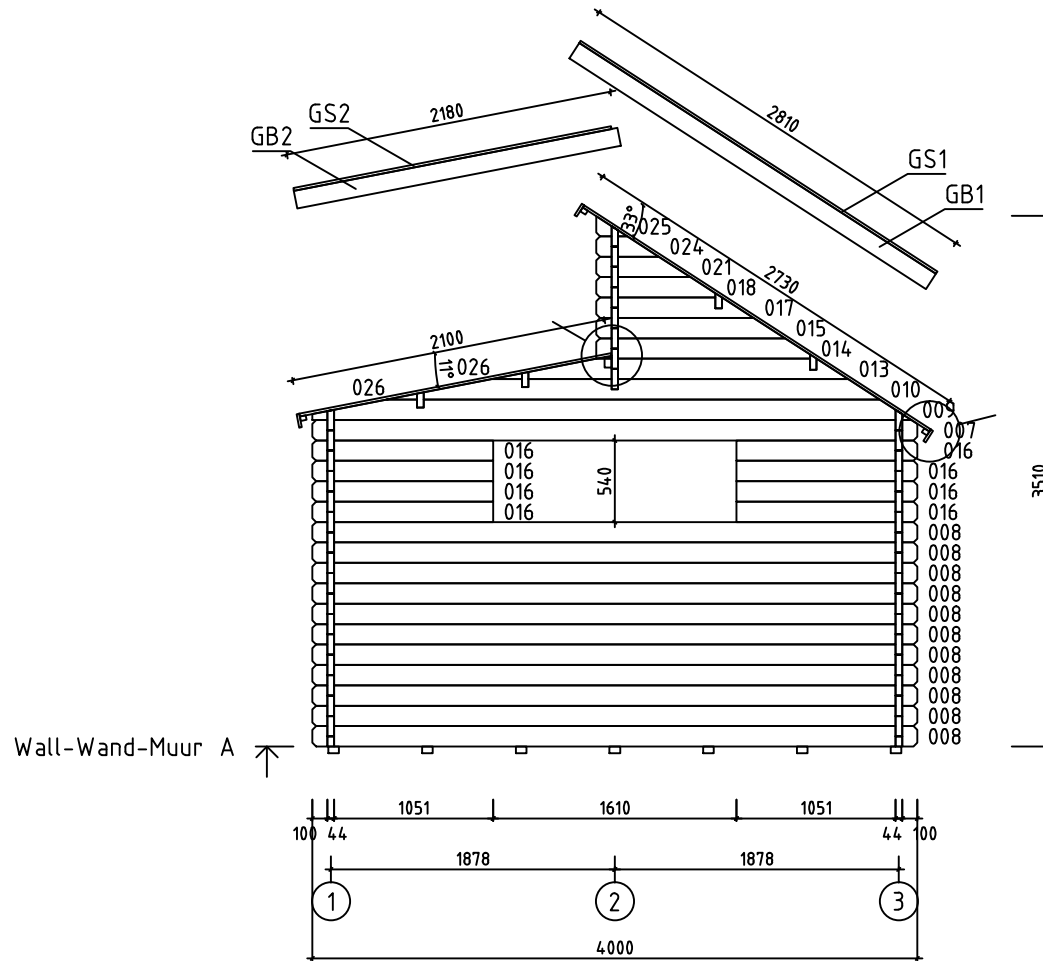
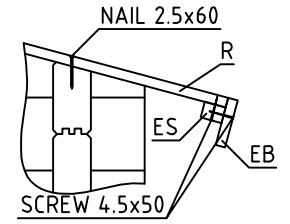
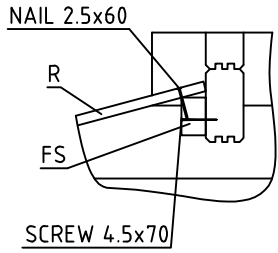



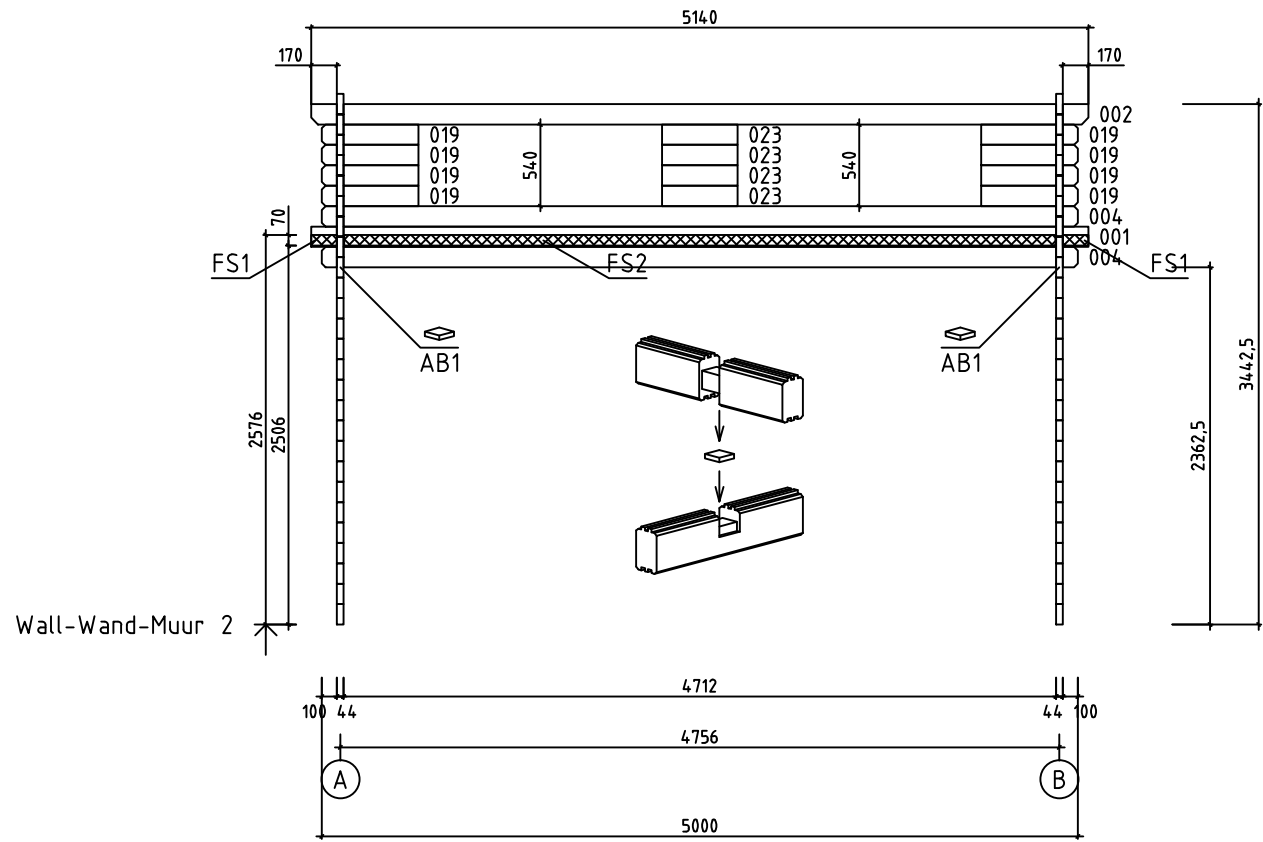



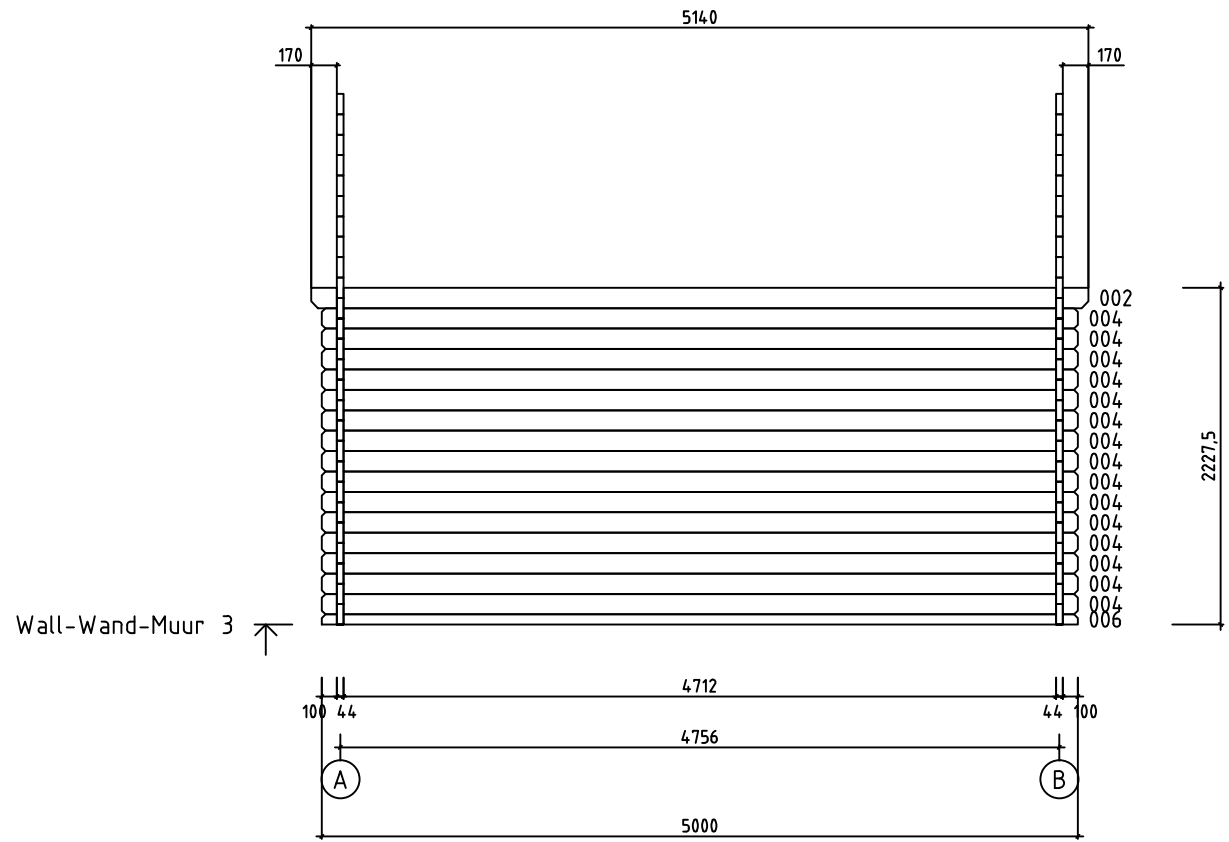

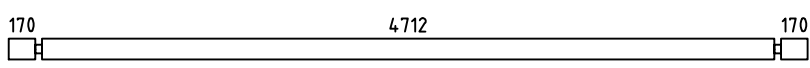
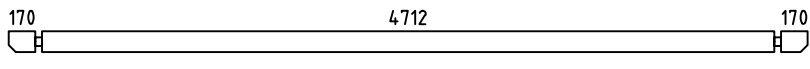
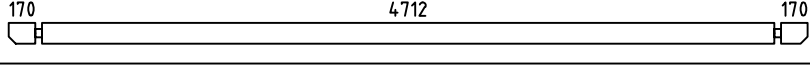
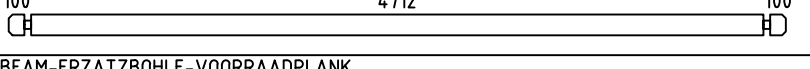
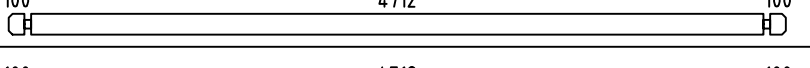
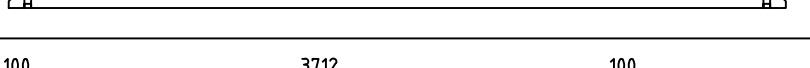
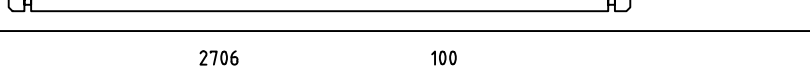
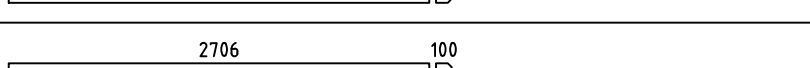
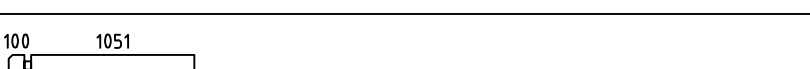
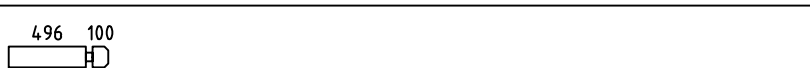

House	Marian 44 ISO	Sheet	7
Drawing	WALL-WAND-MUUR A	Scale	1:50
Material	44x135	Date	26.08.2019
Drawer	RP	File	Marian 44 ISO.dwg

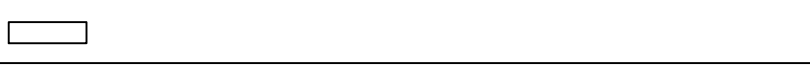

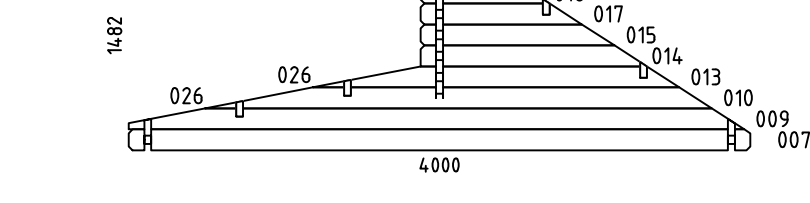

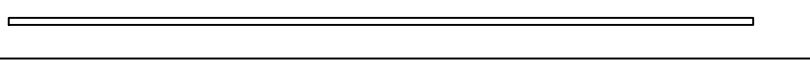

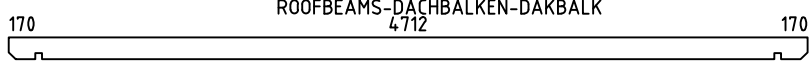
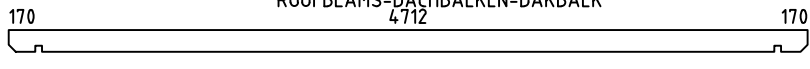















House	Marian 44 ISO	Sheet	10
Drawing	WALL-WAND-MUUR 2	Scale	1:50
Material	44x135	Date	26.08.2019
Drawer	RP	File	Marian 44 ISO.dwg

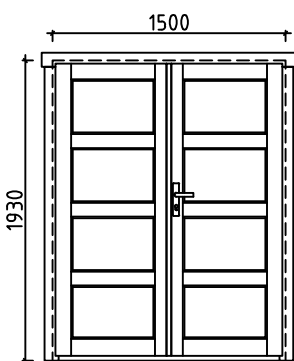
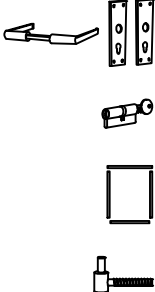

House	Marian 44 ISO	Sheet	11
Drawing	WALL-WAND-MUUR 3	Scale	1:50
Material	44x135	Date	26.08.2019
Drawer	RP	File	Marian 44 ISO.dwg

Pos	Specification-Bestimmung-Omschrijving	Pcs	Profile (mm)	L (mm)	
001		PM	1	44x135	5140
002			2	44x135	5140
003			1	44x135	5140
004			18	44x135	5000
005	SPARE BEAM-ERZATZBOHLE-VOORRAADPLANK 		1	44x135	5000
006			1	44x68	5000
008			26	44x135	4000
011			10	44x135	2850
012			1	44x68	2850
016			8	44x135	1195
019			26	44x135	640
020			1	44x68	640
022			4	44x135	600
023			4	44x135	500
WA-1 WB-1			2	44x1482	4000
HB	HIT BLOCK-SCHLAGHÖLZER-BLAZENPLANK 		2	44x135	300
FBI1	FLOORBEAMS-FUSSBODENBALKEN-VLOERBALKEN 	IMM	7	70x45	4790
FS2	FIXING SLAT-BEFESTIGUNGSLEISTE-BEVESTIGING PLINT 		1	45x70	4705
FS1	FIXING SLAT-BEFESTIGUNGSLEISTE-BEVESTIGING PLINT 		2	45x70	170
RB1	ROOFBEAMS-DACHBALKEN-DAKBALK 		2	43x140	5140
RB2	ROOFBEAMS-DACHBALKEN-DAKBALK 		2	43x140	5140
F1	FLOORBOARD-FUSSBODENBRETT-VLOERPLANK  or-oder-of	42+1 55+1	18x114 18x88	3705	
House	Marian 44 ISO	Material	File	Marian 44 ISO.dwg	Sheet 12

Pos	Specification-Bestimmung-Omschrijving	Pcs	Profile (mm)	L (mm)		
R1	ROOFBOARD-DACHBRETT-DAKPLANK  or-oder-of	46+1 60+1	18x114 18x88	2730		
R2	ROOFBOARD-DACHBRETT-DAKPLANK  or-oder-of	46+1 60+1	18x114 18x88	2100		
FF1	FLOOR FILLET-FUSSBODENLEISTE-VLOERPLINT 		18x35	17m		
GB1	GABLE BOARD-GIEBELBLENDE-GEVELPLANK 	2	18x120	2810		
GB2	GABLE BOARD-GIEBELBLENDE-GEVELPLANK 	2	18x120	2180		
GS1	ROOF FELT FILLET-GIEBELLEISTE-GEVELLIJST 	2	18x70	2810		
GS2	ROOF FELT FILLET-GIEBELLEISTE-GEVELLIJST 	2	18x70	2140		
EB1	EAVE BOARD-TRAUFBRETT-AFDEKPLANK 	6	18x90	2570		
ES1	EAVE SLAT-TRAUFENLEISTE-AFDEKLIJST 	6	30x40	2570		
AB1	ASSEMBLING BOARD-MONTAGE BOARD-MONTAGE PLANK 	2	15x30	30		
SS1	STORM SLAT-STURMLEISTE-STORMLIJST 	2	18x35	3100		
SS2	STORM SLAT-STURMLEISTE-STORMLIJST 	4	18x35	2130		
	SCREWS-SCHRAUBEN-SCHROEF FOR-FÜR-VOOR SS1, SS2 	18	ø6.0	50		
	WASHER-SCHEIBE-SCHIJF FOR-FÜR-VOOR SS1, SS2 	18	ø6.0	18		
	NAIL-NAGEL-NAGEL FOR-FÜR-VOOR FF1 	40	ø2.0	40		
	NAIL-NAGEL-NAGEL FOR-FÜR-VOOR F1, R1, R2 	880	ø2.5	60		
	SCREWS-SCHRAUBEN-SCHROEF FOR-FÜR-VOOR GB1, GB2, GS1, GS2, EB1, ES1 	110	ø4.5	50		
	SCREWS-SCHRAUBEN-SCHROEF FOR-FÜR-VOOR FS1, FS2 	15	ø4.5	70		
	SCREWS-SCHRAUBEN-SCHROEF FOR-FÜR-VOOR 2x008, RB1, RB2 	22	ø6.0	160		
	DOUBLEDOOR-DOPPELTÜR-DUBBELE DEUR (right-rechts-rechts) AST_ISO_PL P  	1 1 1 6	1500	1930		
House	Marian 44 ISO	Material	File	Marian 44 ISO.dwg	Sheet	13

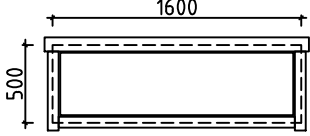
Pos	Specification-Bestimmung-Omschrijving	Pcs	Profile (mm)	L (mm)
	<p data-bbox="263 145 790 179">WINDOW-FENSTER-VENSTER AST_ISO_SU</p> 	1	1600	500
	<p data-bbox="263 392 1165 425">WINDOW-FENSTER-VENSTER (closed-feststehend-gesloten) AST_ISO_K</p> 	3	1600	500

#001	2	5140	1
#002	2,3	5140	2
#003	1	5140	1
#004	1,2,3	5000	18
#005		5000	1
#006	3	5000	1
#007	A,B	4000	2
#008	A,B	4000	26
#009	A,B	3960	2
#010	A,B	3016	2
#011	1	2850	10
#012	1	2850	1
#013	A,B	2114	2
#014	A,B	1413	2
#015	A,B	1248	2
#016	A	1195	8
#017	A,B	1039	2
#018	A,B	787	2
#019	1,2	640	26
#020	1	640	1
#021	A,B	622	2
#022	1	600	4
#023	2	500	4
#024	A,B	413	2
#025	A,B	204	2
#026	A,B	202	4