

House	Marius 4,4 ISO	Sheet	1
Drawing	3D	Scale	
Material	4,4x135	Date	26.08.2019
Drawer	RP	File	Marius 4,4 ISO 3D.dwg

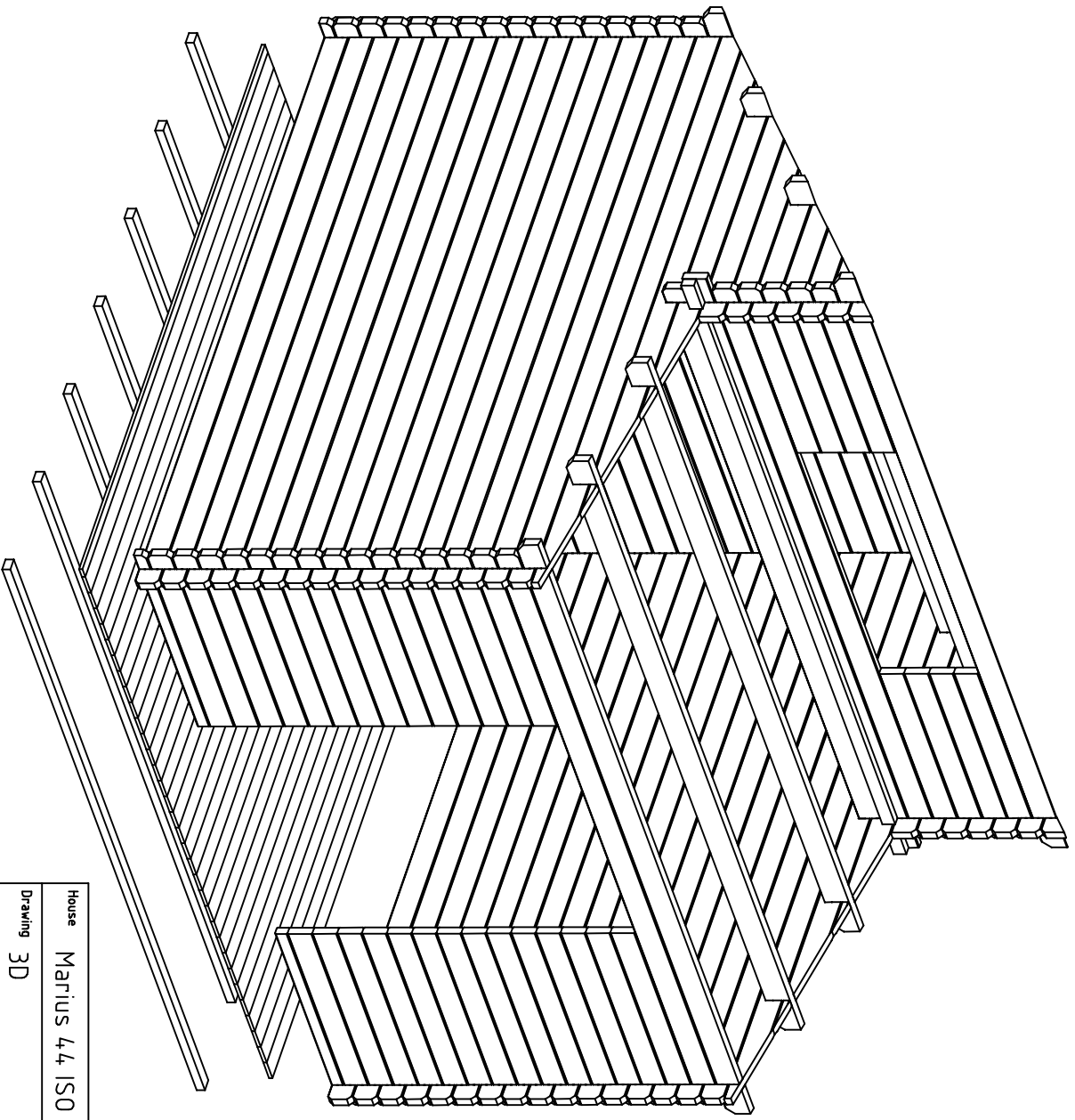

House	Marius 4,4 ISO	Sheet	2
Drawing	3D	Scale	
Material	4,4x135	Date	26.08.2019
Drawer	RP	File	Marius 4,4 ISO 3D.dwg

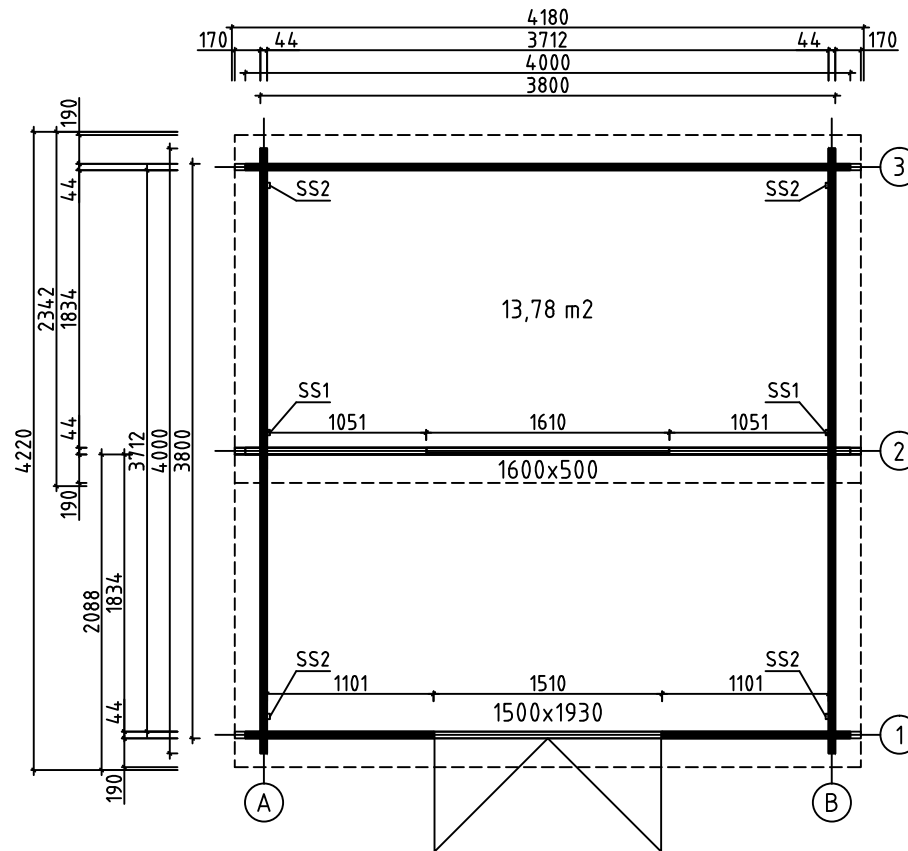

House	Marius 44 ISO	Sheet	3
Drawing	GRUNDPLAN-GRUNDPLAN-PLAN	Scale	1:50
Material	44x135	Date	26.08.2019
Drawer	RP	File	Marius 44 ISO.dwg

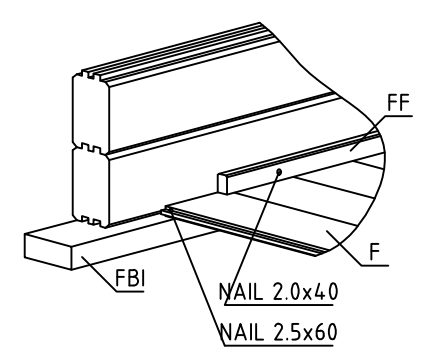
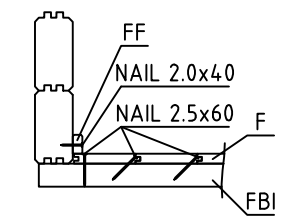
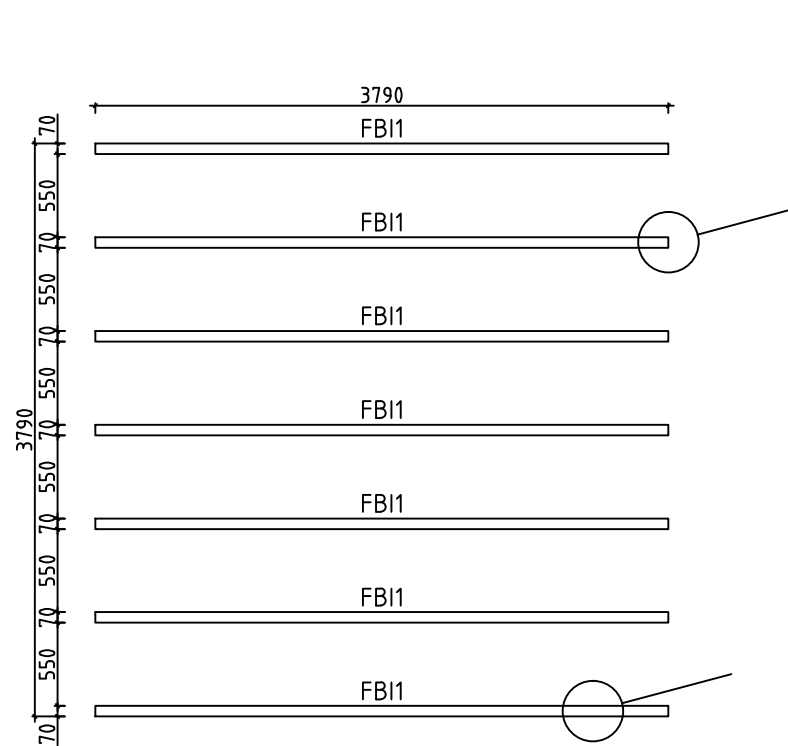

House	Marius 44 ISO	Sheet	4
Drawing	FLOORBEAMS-FUSSBODENBALKEN-VLOERBALKEN	Scale	1:50
Material	70x45	Date	26.08.2019
Drawer	RP	File	Marius 44 ISO.dwg

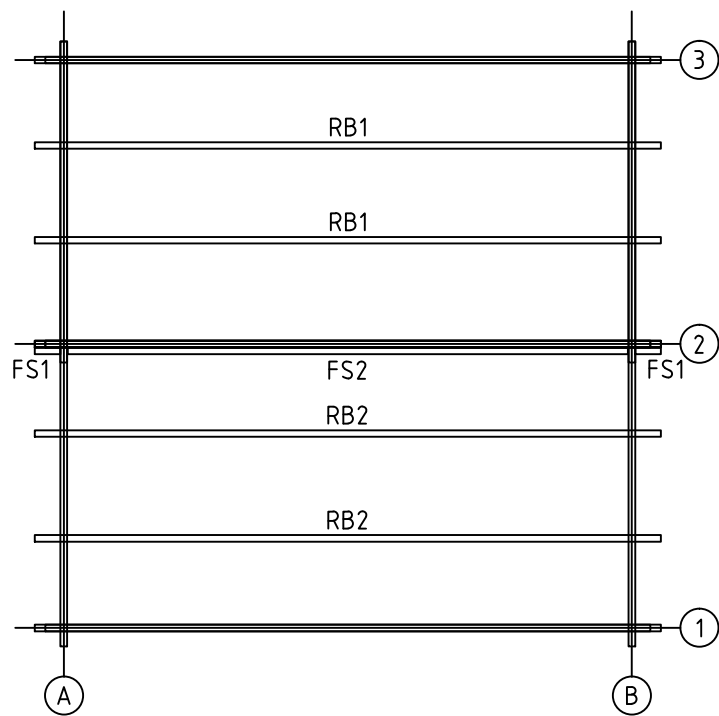



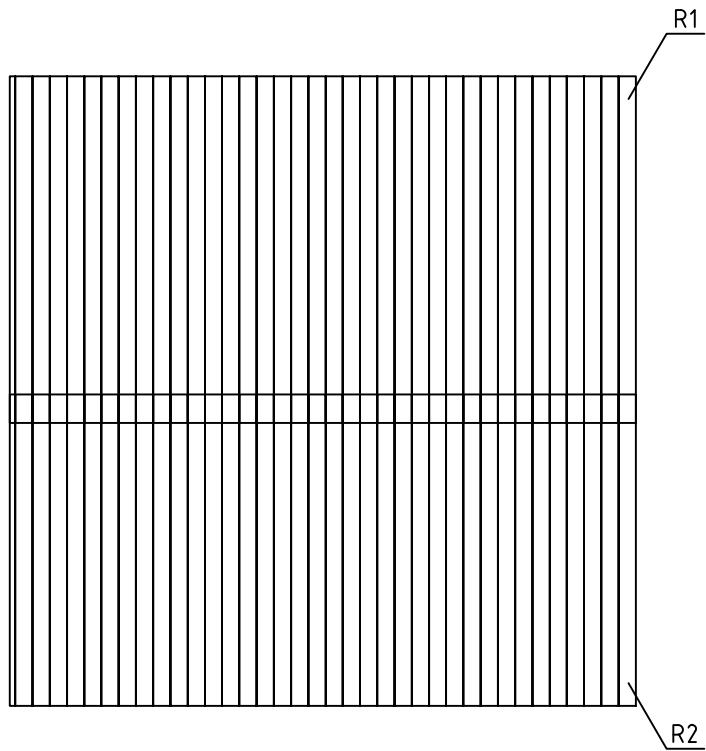



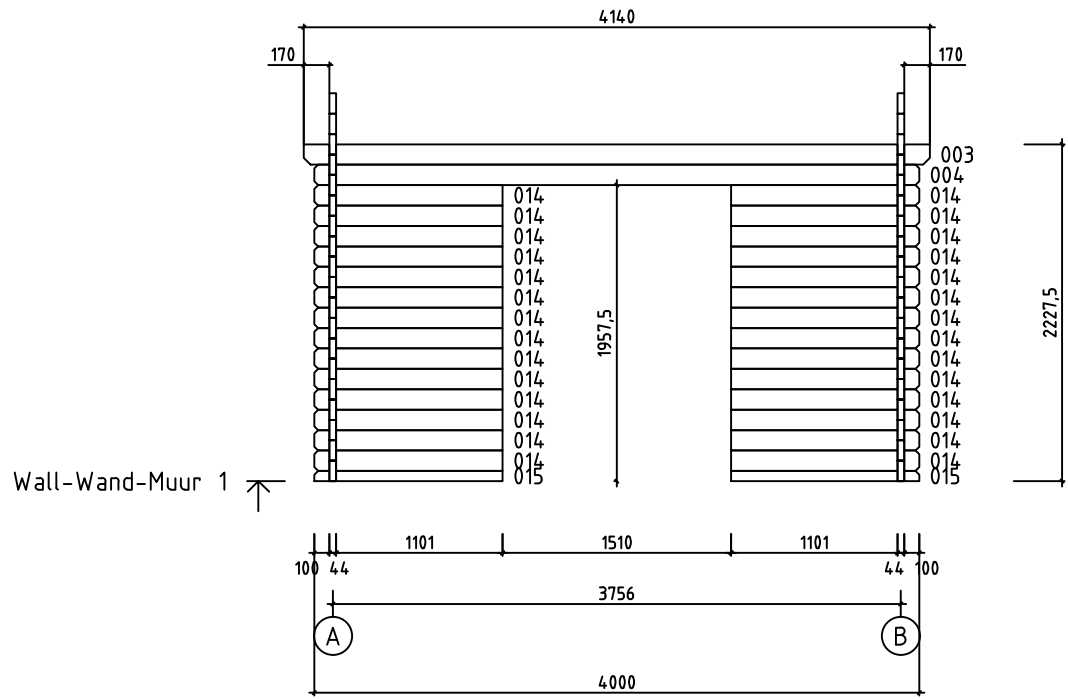

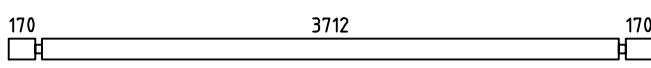
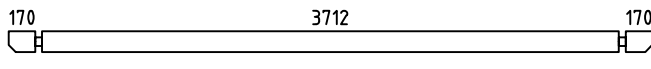
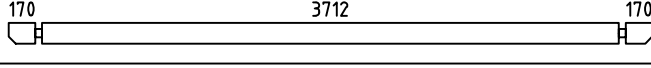
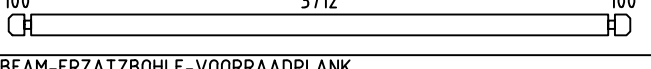
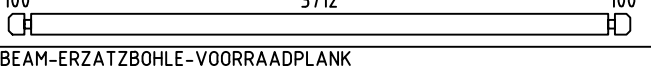
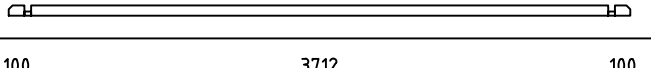
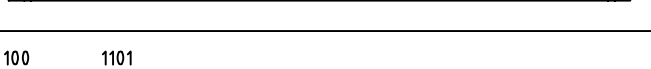
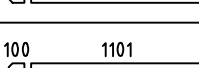
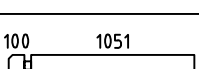
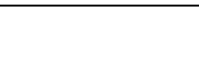
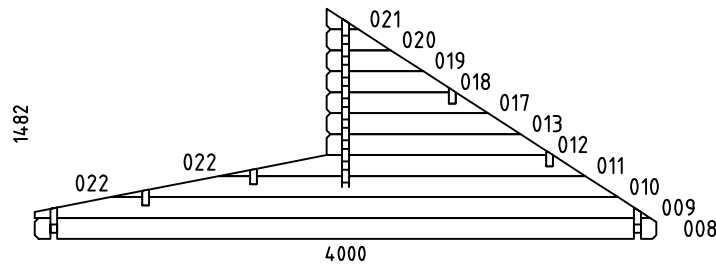

House	Marius 44 ISO	Sheet	5
Drawing	ROOFBEAMS-DACHBALKEN-DAKBALK	Scale	1:50
Material	43x140, 45x70	Date	26.08.2019
Drawer	RP	File	Marius 44 ISO.dwg



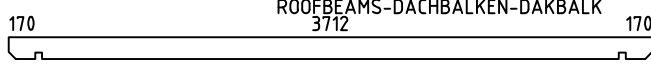
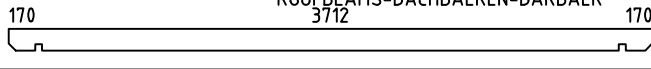













House	Marius 44 ISO	Sheet	6
Drawing	ROOFBOARD-DACHBRETT-DAKPLANK	Scale	1:50
Material	18x114	Date	26.08.2019
Drawer	RP	File	Marius 44 ISO.dwg



House	Marius 44 ISO	Sheet	9
Drawing	WALL-WAND-MUUR 1	Scale	1:50
Material	44x135	Date	26.08.2019
Drawer	RP	File	Marius 44 ISO.dwg

Pos	Specification-Bestimmung-Omschrijving	Pcs	Profile (mm)	L (mm)	
001		PM	1	44x135	4140
002			2	44x135	4140
003			1	44x135	4140
004			48	44x135	4000
005	SPARE BEAM-ERZATZBOHLE-VOORRAADPLANK 		1	44x135	4000
006	SPARE BEAM-ERZATZBOHLE-VOORRAADPLANK 		1	44x68	4000
007			1	44x68	4000
014			28	44x135	1245
015			2	44x68	1245
016			8	44x135	1195
WA-1 WB-1			2	44x1482	4000
HB	HIT BLOCK-SCHLAGHÖLZER-BLAZENPLANK 		2	44x135	300
FBI1	FLOORBEAMS-FUSSBODENBALKEN-VLOERBALKEN 	IMM	7	70x45	3790
FS2	FIXING SLAT-BEFESTIGUNGSLEISTE-BEVESTIGING PLINT 		1	45x70	3705
FS1	FIXING SLAT-BEFESTIGUNGSLEISTE-BEVESTIGING PLINT 		2	45x70	170
RB1	ROOFBEAMS-DACHBALKEN-DAKBALK 		2	43x140	4140
RB2	ROOFBEAMS-DACHBALKEN-DAKBALK 		2	43x140	4140
F1	FLOORBOARD-FUSSBODENBRETT-VLOERPLANK  or-oder-of	33+1 43+1	18x114 18x88	3705	
R1	ROOFBOARD-DACHBRETT-DAKPLANK  or-oder-of	37+1 48+1	18x114 18x88	2730	
R2	ROOFBOARD-DACHBRETT-DAKPLANK  or-oder-of	37+1 48+1	18x114 18x88	2100	
FF1	FLOOR FILLET-FUSSBODENLEISTE-VLOERPLINT 		18x35	15m	
GB1	GABLE BOARD-GIEBELLENDE-GEVELPLANK 		2	18x120	2810
House	Marius 44 ISO	Material	File	Marius 44 ISO.dwg	Sheet 12

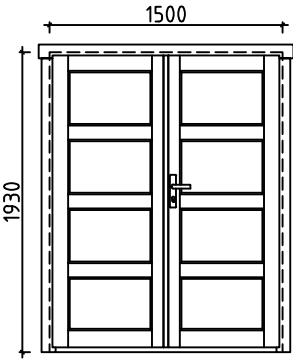
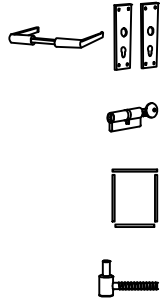
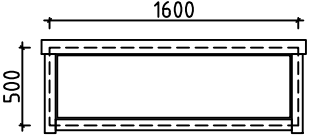
Pos	Specification-Bestimmung-Omschrijving	Pcs	Profile (mm)	L (mm)
GB2	GABLE BOARD-GIEBELBLENDE-GEVELPLANK 	2	18x120	2180
GS1	ROOF FELT FILLET-GIEBELLEISTE-GEVELLIJST 	2	18x70	2810
GS2	ROOF FELT FILLET-GIEBELLEISTE-GEVELLIJST 	2	18x70	2140
EB1	EAVE BOARD-TRAUFBRETT-AFDEKPLANK 	6	18x90	2070
ES1	EAVE SLAT-TRAUFENLEISTE-AFDEKLIJST 	6	30x40	2070
AB1	ASSEMBLING BOARD-MONTAGE BOARD-MONTAGE PLANK 	2	15x30	30
SS1	STORM SLAT-STURMLEISTE-STORMLIJST 	2	18x35	3100
SS2	STORM SLAT-STURMLEISTE-STORMLIJST 	4	18x35	2130
	SCREWS-SCHRAUBEN-SCHROEF FOR-FÜR-VOOR SS1, SS2 	18	Ø6.0	50
	WASHER-SCHEIBE-SCHIJF FOR-FÜR-VOOR SS1, SS2 	18	Ø6.0	18
	NAIL-NAGEL-NAGEL FOR-FÜR-VOOR FF1 	40	Ø2.0	40
	NAIL-NAGEL-NAGEL FOR-FÜR-VOOR F1, R1, R2 	700	Ø2.5	60
	SCREWS-SCHRAUBEN-SCHROEF FOR-FÜR-VOOR GB1, GB2, GS1, GS2, EB1, ES1 	100	Ø4.5	50
	SCREWS-SCHRAUBEN-SCHROEF FOR-FÜR-VOOR FS1, FS2 	10	Ø4.5	70
	SCREWS-SCHRAUBEN-SCHROEF FOR-FÜR-VOOR 2x004, RB1, RB2 	22	Ø6.0	160
	DOUBLEDOR-DOPPELTÜR-DUBBELE DEUR (right-rechts-rechts) AST_ISO_PL P  	1	1500	1930
	WINDOW-FENSTER-VENSTER (closed-feststehend-gesloten) AST_ISO_K 	1	1600	500

#001	2	4140	1
#002	2,3	4140	2
#003	1	4140	1
#004	1,2,3,A,B	4000	48
#005		4000	1
#006		4000	1
#007	3	4000	1
#008	A,B	4000	2
#009	A,B	3960	2
#010	A,B	3016	2
#011	A,B	2114	2
#012	A,B	1413	2
#013	A,B	1248	2
#014	1	1245	28
#015	1	1245	2
#016	2	1195	8
#017	A,B	1039	2
#018	A,B	787	2
#019	A,B	622	2
#020	A,B	413	2
#021	A,B	204	2
#022	A,B	202	4