

House Nina 44, ISO

Drawing 3D

Material 44x135

Drawer RP

Sheet 1

Scale

Date 28.08.2019

File Nina 44, ISO 3D.dwg

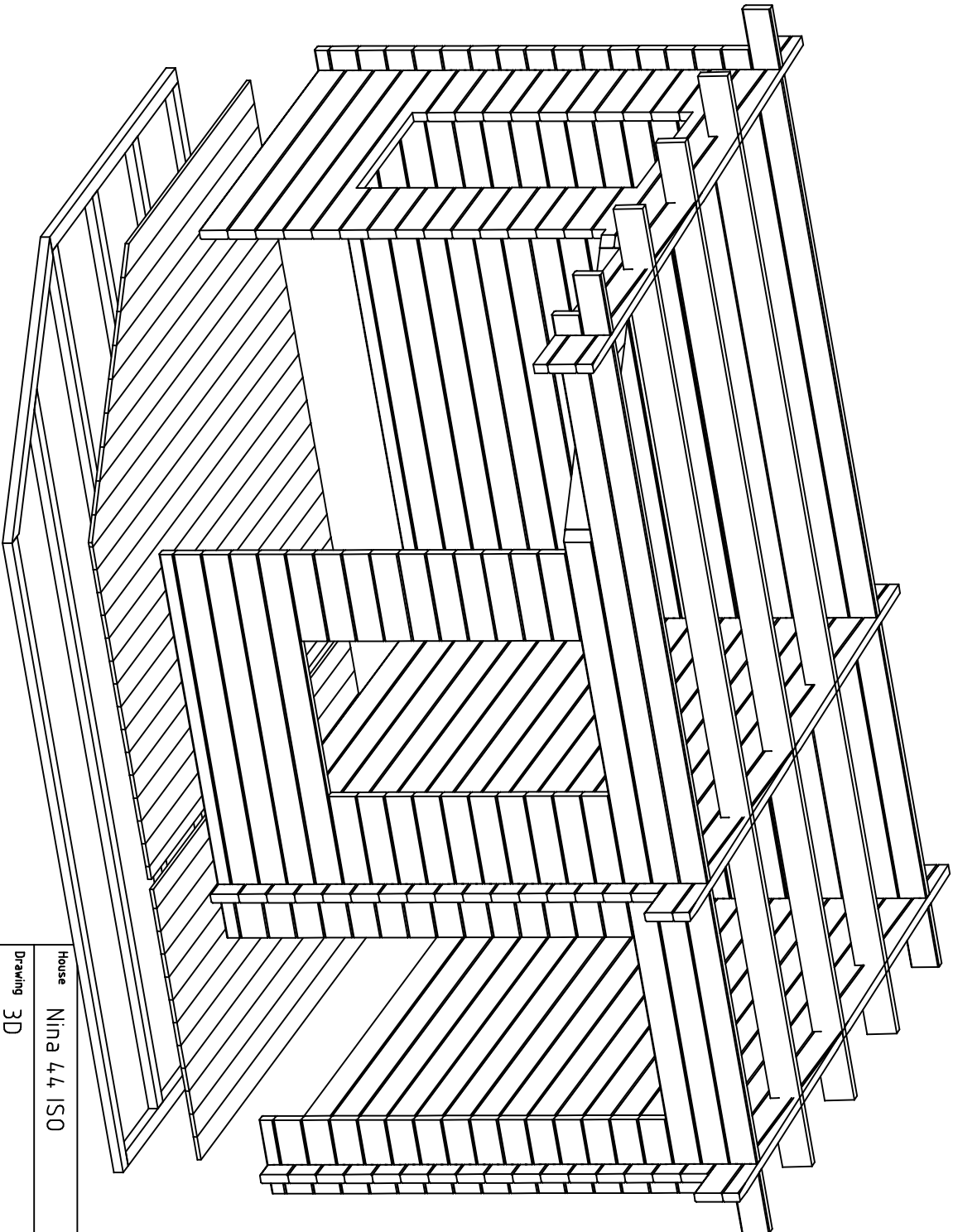

House Nina 44 ISO

Sheet 2

Drawing 3D

Scale

Material 44x135

Date 28.08.2019

Drawer RP

File Nina 44 ISO 3D.dwg

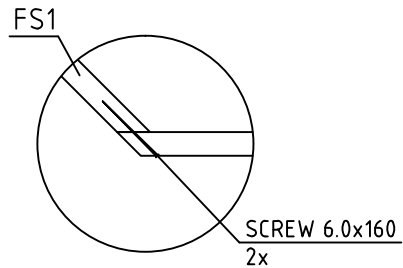
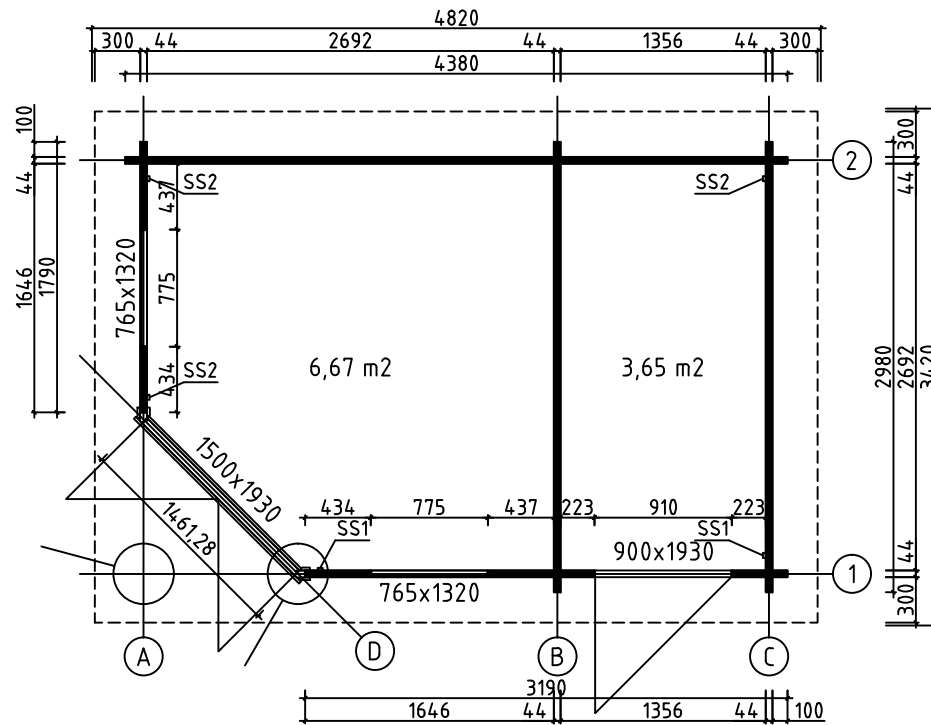
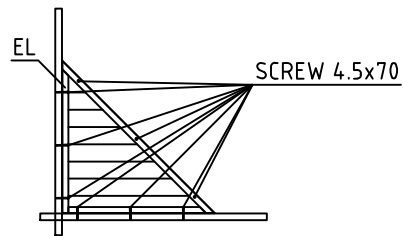

House	Nina 44 ISO	Sheet	3
Drawing	GROUNDPLAN-GRUNDPLAN-PLAN	Scale	1:50
Material	44x135	Date	28.08.2019
Drawer	RP	File	Nina 44 ISO.dwg

FLOORBOARD-FUSSBODENBRETT-VLOERPLANK

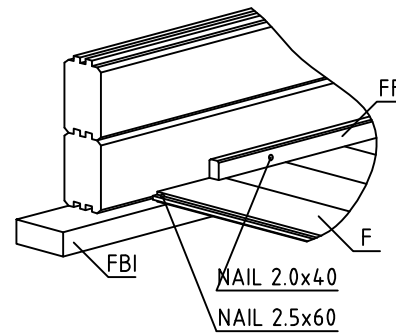
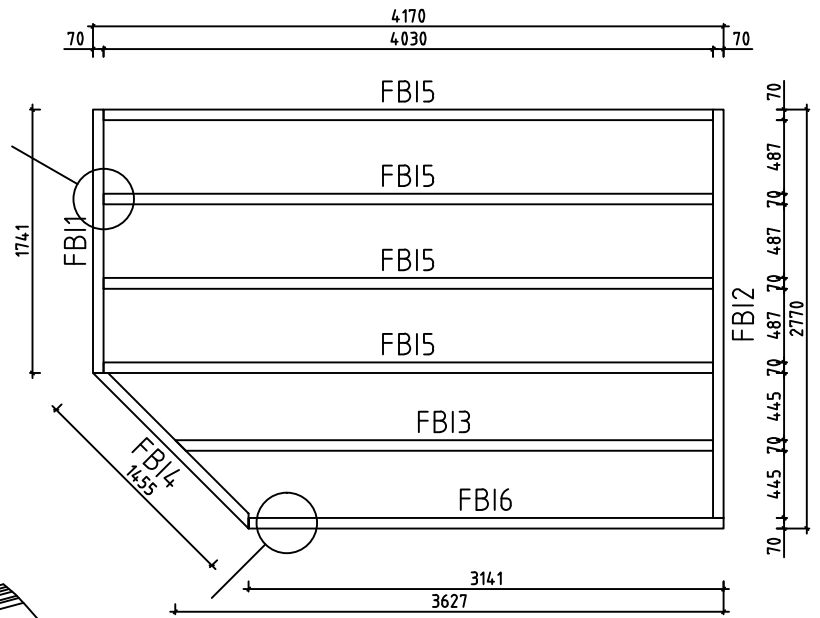
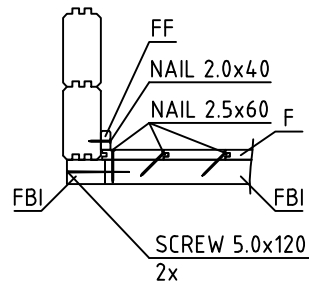
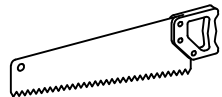
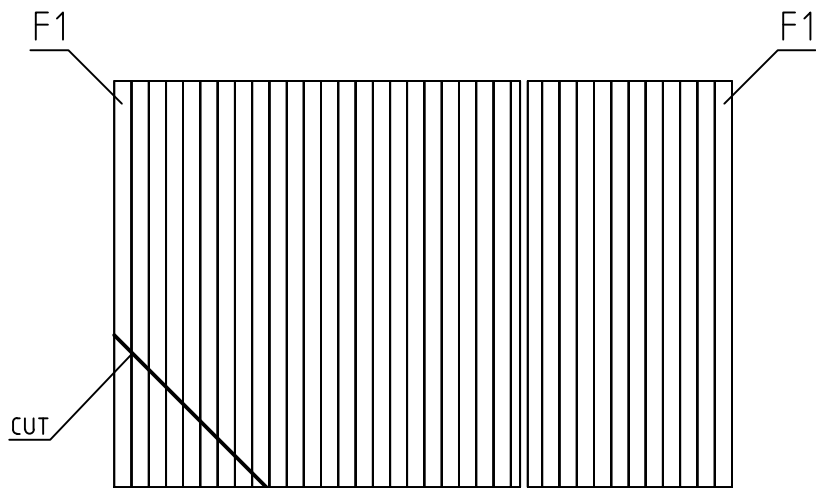

House	Nina 44 ISO	Sheet	4
Drawing	FLOORBEAMS-FUSSBODENBALKEN-VLOERBALKEN	Scale	1:50
Material	18x114 70x45	Date	28.08.2019
Drawer	RP	File	Nina 44 ISO.dwg

ROOFBOARD-DACHBRETT-DAKPLANK

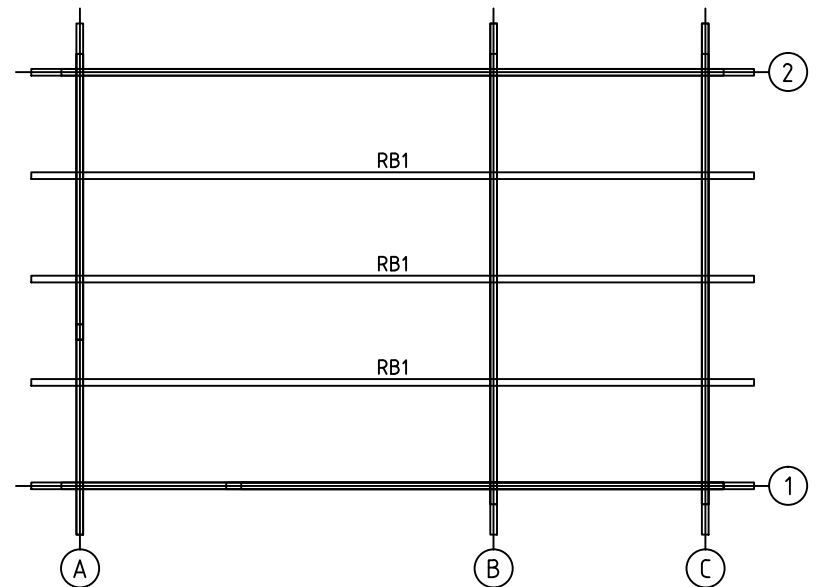
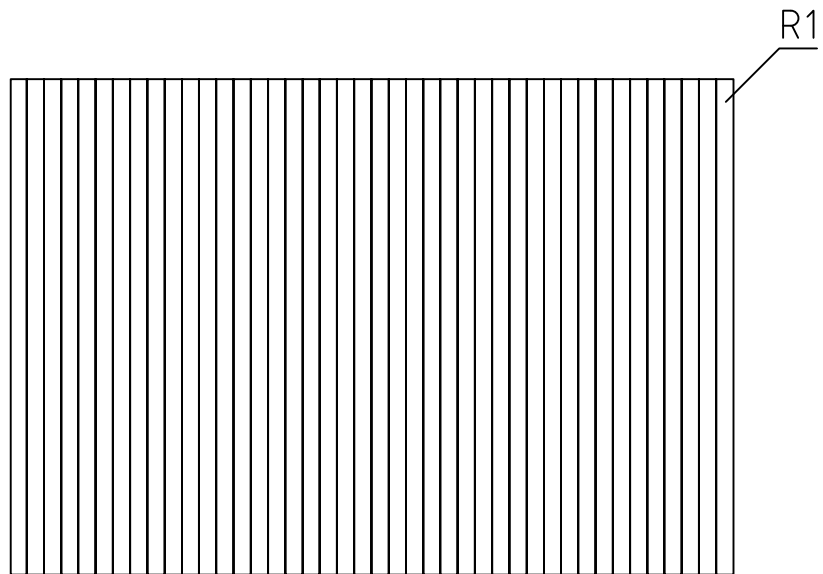



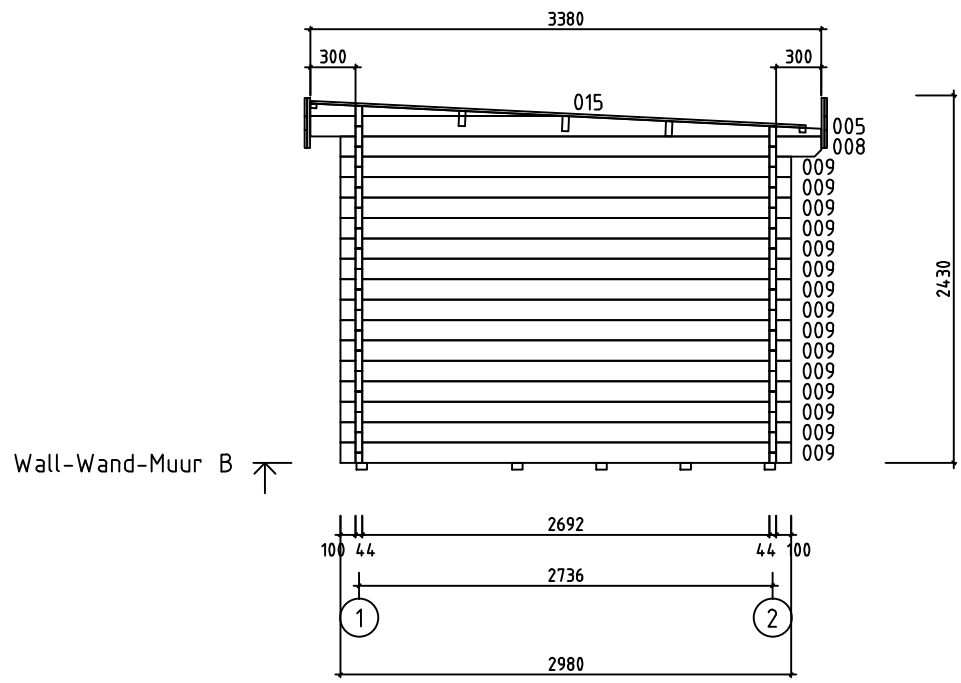



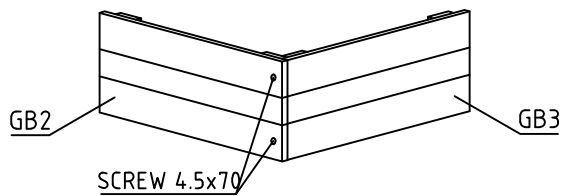
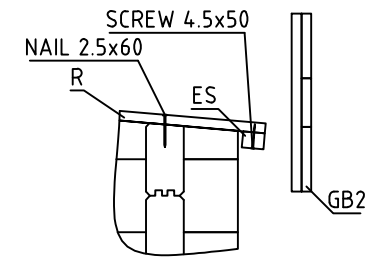
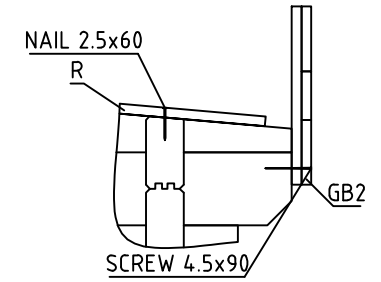
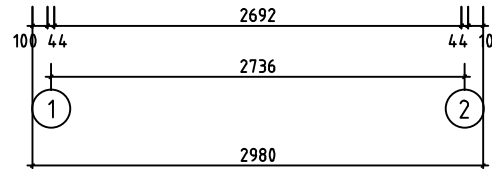
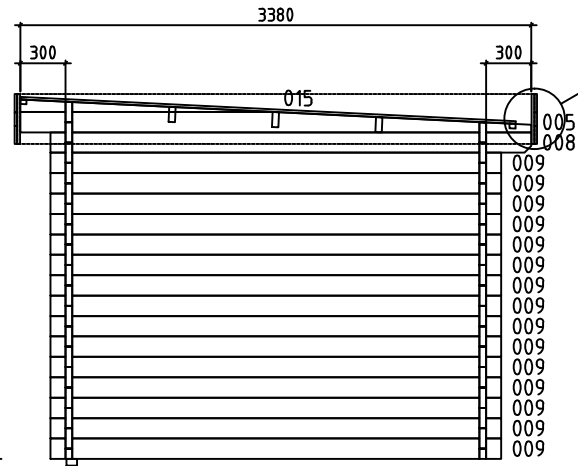
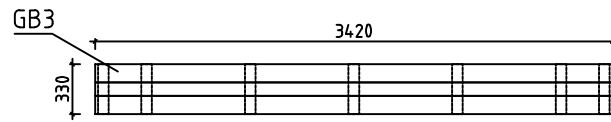

House	Nina 44 ISO	Sheet	5
Drawing	ROOFBEAMS-DACHBALKEN-DAKBALK	Scale	1:50
Material	18x114 43x140	Date	28.08.2019
Drawer	RP	File	Nina 44 ISO.dwg

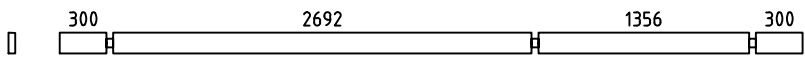
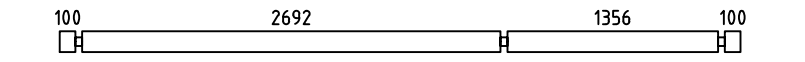
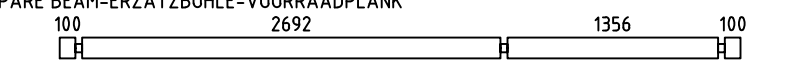
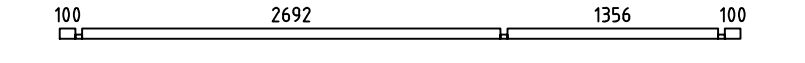
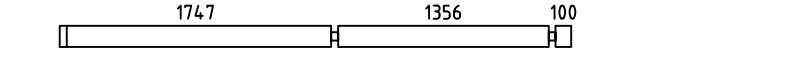
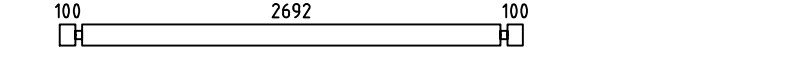



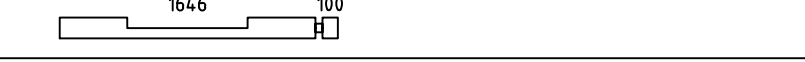
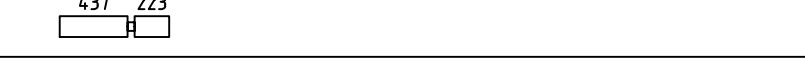
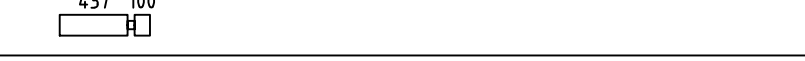
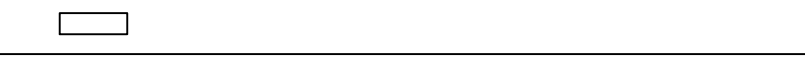
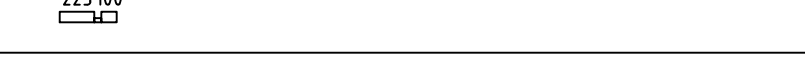

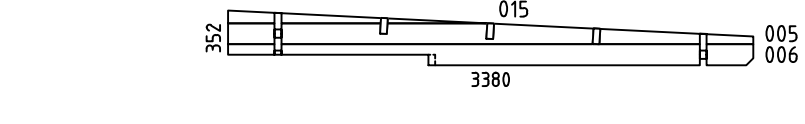
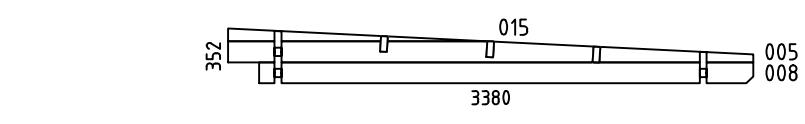

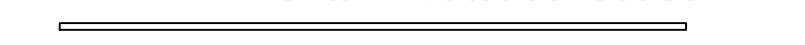
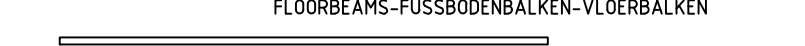
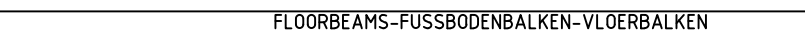
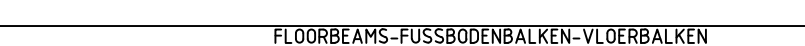

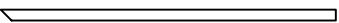
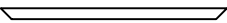

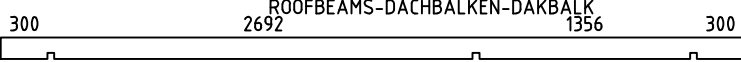



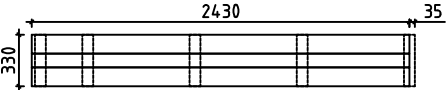
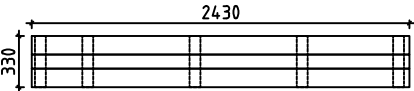
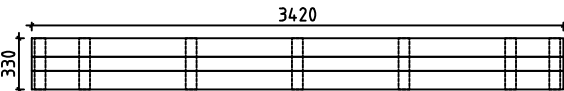



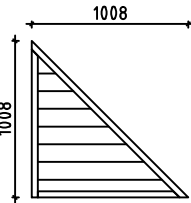









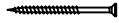
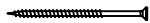

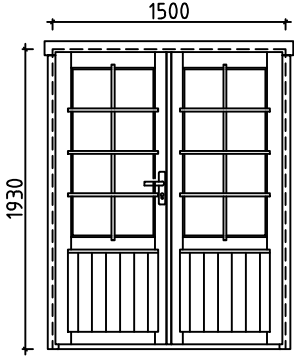
House	Nina 44 ISO	Sheet	7
Drawing	WALL-WAND-MUUR B	Scale	1:50
Material	44x135	Date	28.08.2019
Drawer	RP	File	Nina 44 ISO.dwg

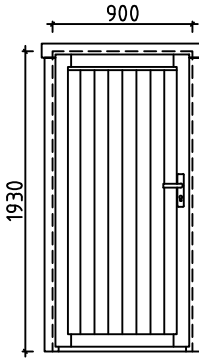

House	Nina 44 ISO	Sheet	8
Drawing	WALL-WAND-MUUR C	Scale	1:50
Material	44x135	Date	28.08.2019
Drawer	RP	File	Nina 44 ISO.dwg

Pos	Specification-Bestimmung-Omschrijving	Pcs	Profile (mm)	L (mm)	
001		2	44x135	4780	
002		16	44x135	4380	
003	SPARE BEAM-ERZATZBOHLE-VOORRAADPLANK 	1	44x135	4380	
004		1	44x68	4380	
007		1	44x135	3291	
009		30	44x135	2980	
010		1	44x68	1913	
011		4	44x135	1913	
012		1	44x135	1891	
013		4	44x135	1790	
014		1	44x135	1790	
016		10	44x135	704	
017		9	44x135	581	
018		19	44x135	434	
019		1	44x68	367	
020		14	44x135	367	
WA-1		1	44x352	3380	
WB-1 WC-1		2	44x352	3380	
HB	HIT BLOCK-SCHLAGHÖLZER-BLAZENPLANK 	2	44x135	300	
FBI5	FLOORBEAMS-FUSSBÖDENBALKEN-VLOERBALKEN 	IMM	4	70x45	4030
FBI6	FLOORBEAMS-FUSSBÖDENBALKEN-VLOERBALKEN 	IMM	1	70x45	3141
FBI2	FLOORBEAMS-FUSSBÖDENBALKEN-VLOERBALKEN 	IMM	1	70x45	2700
FBI1	FLOORBEAMS-FUSSBÖDENBALKEN-VLOERBALKEN 	IMM	1	70x45	1741
House	Nina 44 ISO	Material	File	Nina 44 ISO.dwg	Sheet 11

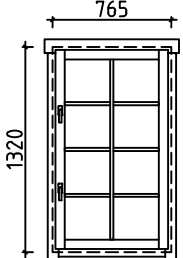
Pos	Specification-Bestimmung-Omschrijving	Pcs	Profile (mm)	L (mm)	
FBI3	FLOORBEAMS-FUSSBODENBALKEN-VLOERBALKEN 	IMM	1	45x70	2157
FBI4	FLOORBEAMS-FUSSBODENBALKEN-VLOERBALKEN 	IMM	1	45x70	1455
FS1	FIXING SLAT-BEFESTIGUNGSLEISTE-BEVESTIGING PLINT 		1	140x43	1425
RB1	ROOFBEAMS-DACHBALKEN-DAKBALK 		3	43x140	4780
F1	FLOORBOARD-FUSSBODENBRETT-VLOERPLANK  or-oder-of		36+1 47+1	18x114 18x88	2685
R1	ROOFBOARD-DACHBRETT-DAKPLANK  or-oder-of		42+1 55+1	18x114 18x88	3280
FF1	FLOOR FILLET-FUSSBODENLEISTE-VLOERPLINT 			18x35	19m
GB1			2	36x330	2430 +35
GB2			2	36x330	2430
GB3			2	36x330	3420
ES1	EAVE SLAT-TRAUFENLEISTE-AFDEKLIJST 		2	30x40	2690
ES2	EAVE SLAT-TRAUFENLEISTE-AFDEKLIJST 		2	30x40	1355
ES3	EAVE SLAT-TRAUFENLEISTE-AFDEKLIJST 		4	30x40	300
AB1	ASSEMBLING BOARD-MONTAGE BOARD-MONTAGE PLANK 		2	15x30	30
EL	ELEMENT-ELEMENTE-ELEMENTEN 		1	48x1008	1008
SS1	STORM SLAT-STURMLEISTE-STORMLIJST 		2	18x35	2190
SS2	STORM SLAT-STURMLEISTE-STORMLIJST 		3	18x35	2090
	SCREWS-SCHRAUBEN-SCHROEF FOR-FÜR-VOOR SS1, SS2 		15	ø6.0	50
	WASHER-SCHEIBE-SCHIJF FOR-FÜR-VOOR SS1, SS2 		15	ø6.0	18
House	Nina 44 ISO	Material	File	Nina 44 ISO.dwg	Sheet 12

Pos	Specification-Bestimmung-Omschrijving	Pcs	Profile (mm)	L (mm)
	NAIL-NAGEL-NAGEL FOR-FÜR-VOOR FF1 	40	∅2.0	40
	NAIL-NAGEL-NAGEL FOR-FÜR-VOOR F1, R1 	570	∅2.5	60
	SCREWS-SCHRAUBEN-SCHROEF FOR-FÜR-VOOR GB1, GB2 	6	∅3.5	35
	SCREWS-SCHRAUBEN-SCHROEF FOR-FÜR-VOOR ES1, ES2, ES3 	30	∅4.5	50
	SCREWS-SCHRAUBEN-SCHROEF FOR-FÜR-VOOR EL, GB1, GB2, GB3 	30	∅4.5	70
	SCREWS-SCHRAUBEN-SCHROEF FOR-FÜR-VOOR 004, 010, 019, GB1, GB2, GB3 	40	∅4.5	90
	SCREWS-SCHRAUBEN-SCHROEF FOR-FÜR-VOOR FBI1, FBI2, FBI3, FBI4, FBI5, FBI6 	30	∅5.0	120
	SCREWS-SCHRAUBEN-SCHROEF FOR-FÜR-VOOR 002, 006, RB1 	11	∅6.0	160
	DOUBLEDOR-DOPPELTÜR-DUBBELE DEUR (left-links-links) AST_ISO_PL V 	1	1500	1930
		1		
		1		
		1		
		6		
		2		
	DOOR-TÜR-DEUR (left-links-links) AST_ISO_PL V 	1	900	1930
		1		
		1		
	WINDOW-FENSTER-VENSTER (1x right-rechts-rechts; 1x left-links-links) AST_ISO_KP P+V 	1+1	765	1320
		4		
		2		
House	Nina 44 ISO	Material	File	Nina 44 ISO.dwg
			Sheet	13

#001	1,2	4780	2
#002	1,2	4380	16
#003		4380	1
#004	2	4380	1
#005	A,B,C	3380	3
#006	A	3380	1
#007	1	3291	1
#008	B,C	3180	2
#009	B,C	2980	30
#010	1	1913	1
#011	1	1913	4
#012	A	1891	1
#013	A	1790	4
#014	A	1790	1
#015	A,B,C	1668	3
#016	1	704	10
#017	A	581	9
#018	1,A	434	19
#019	1	367	1
#020	1	367	14