

Date rev. Description

V 1.0

House	Sabrina - 44	Sheet	1
Drawing	3D	Scale	
Material	44x135	Date	16.09.2019
Drawer	K.K.	File	Sabrina - 44 3D.dwg

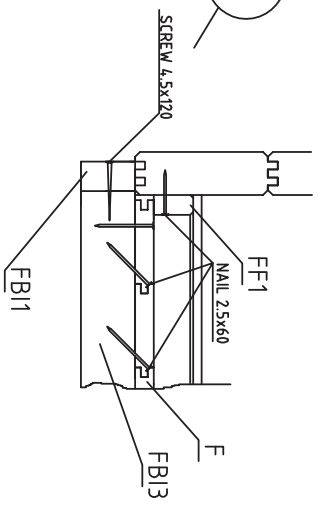
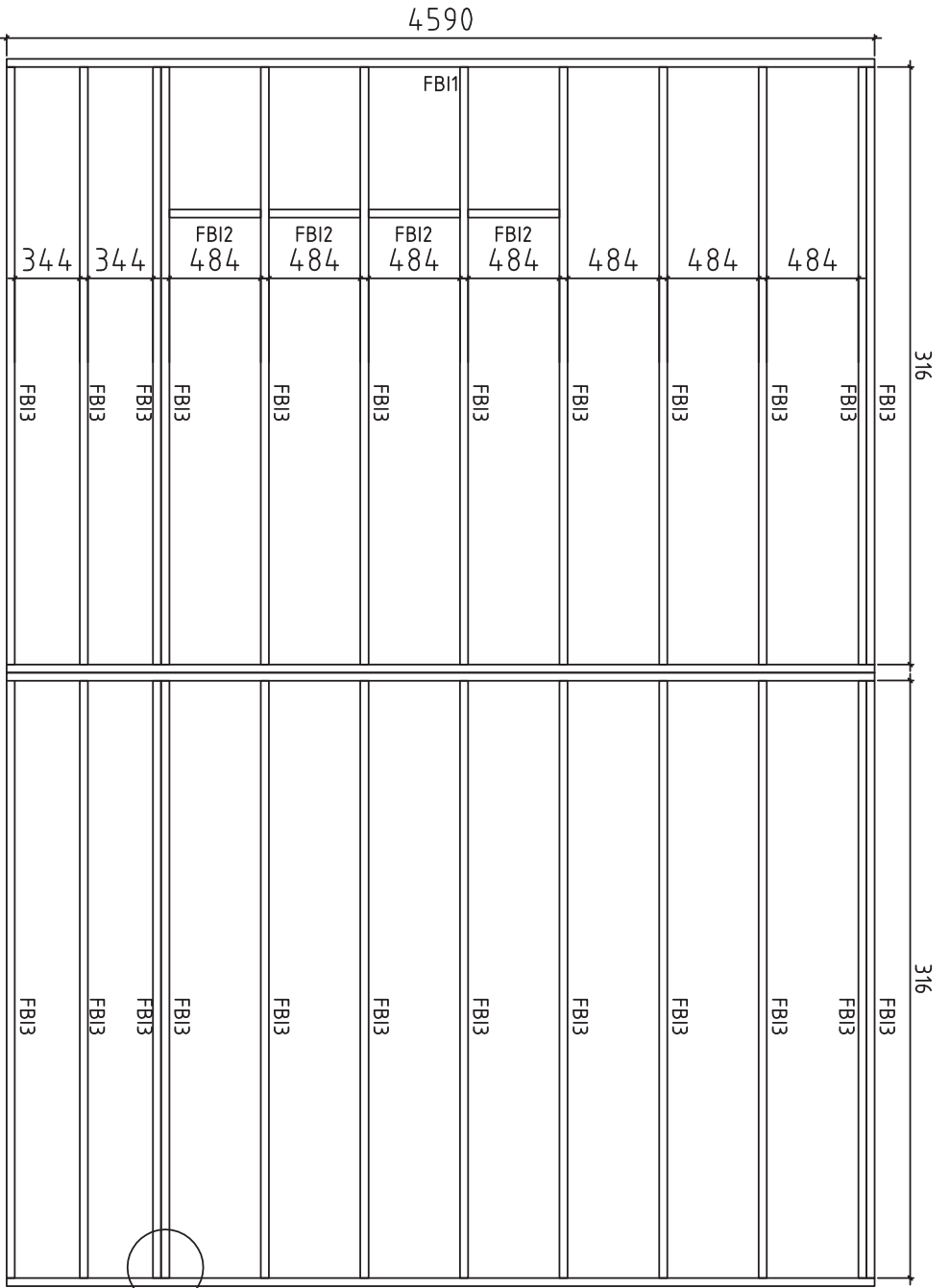

House	Sabrina - 44	Sheet	2
Drawing	Plan	Scale	1:35
Material	4.3x70	Date	16.09.2019
Drawer	K.K.	File	Sabrina - 44.dwg

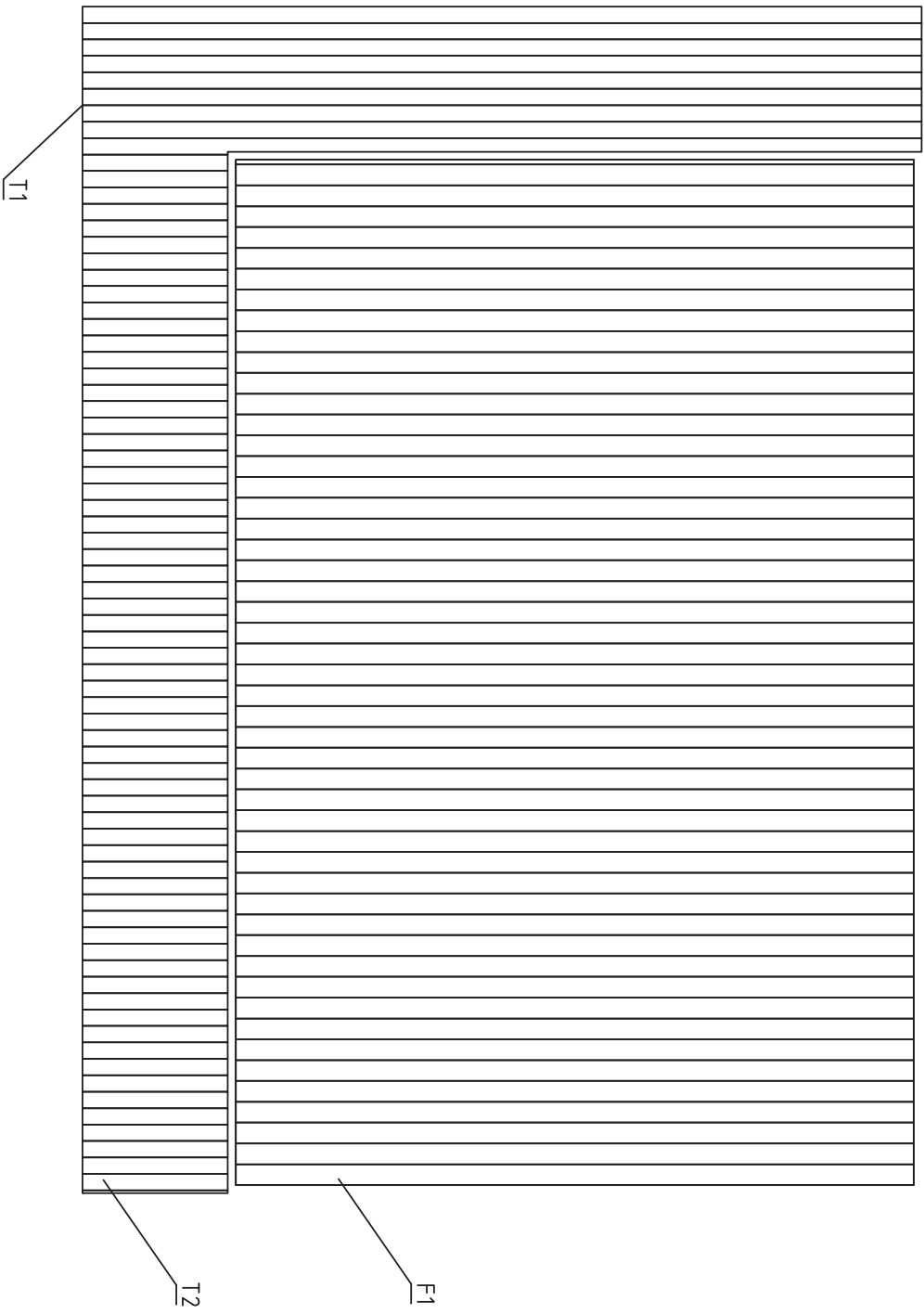

House	Sabrina - 44	Sheet	3
Drawing	Plan	Scale	1:35
Material	4,4x135	Date	16.09.2019
Drawer	K.K.	File	Sabrina - 44.dwg

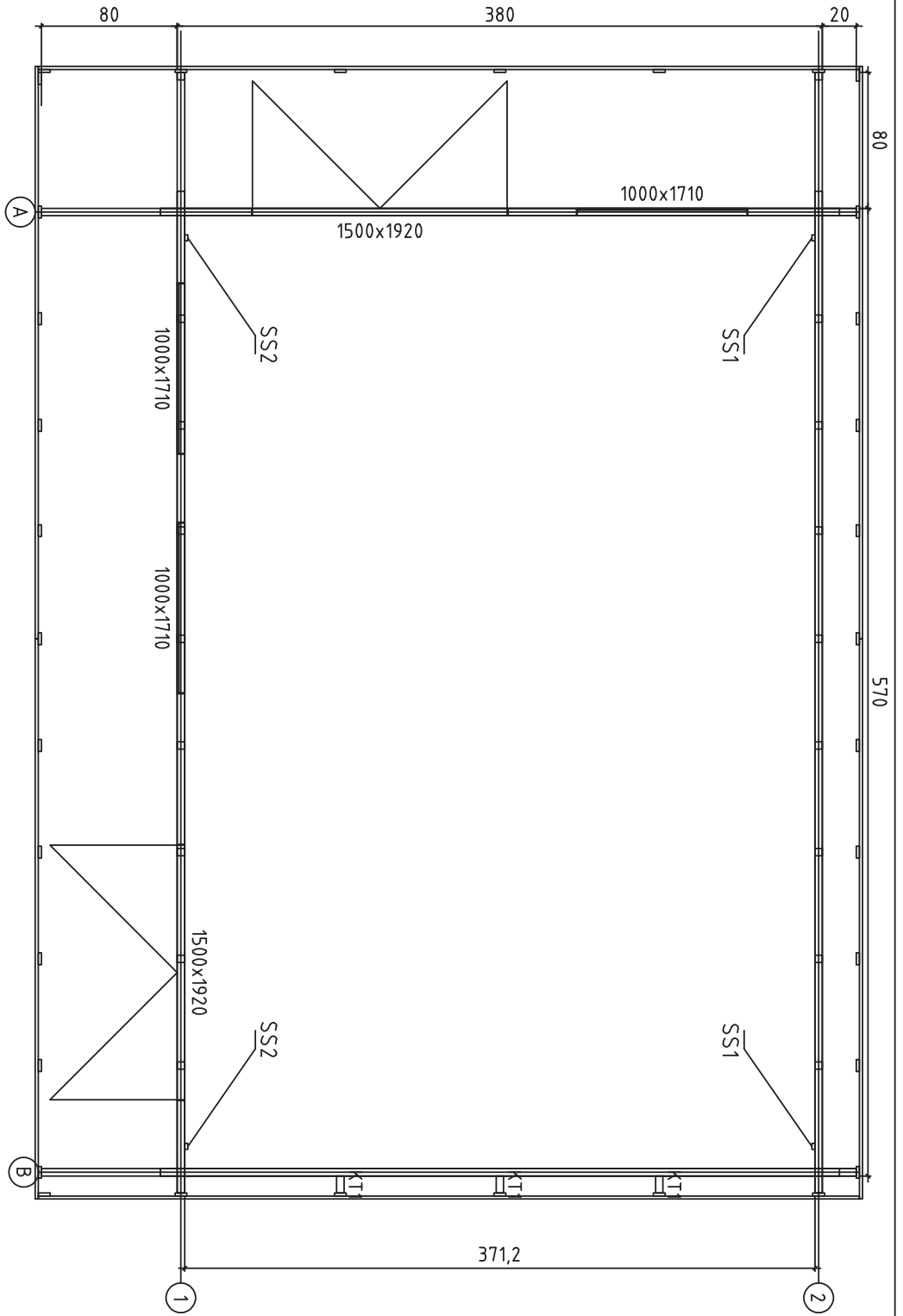

House	Sabrina - 44	Sheet	4
Drawing	Plan	Scale	1:35
Material	44x135	Date	28.07.2023
Drawer	K.K.	File	Sabrina - 44.dwg

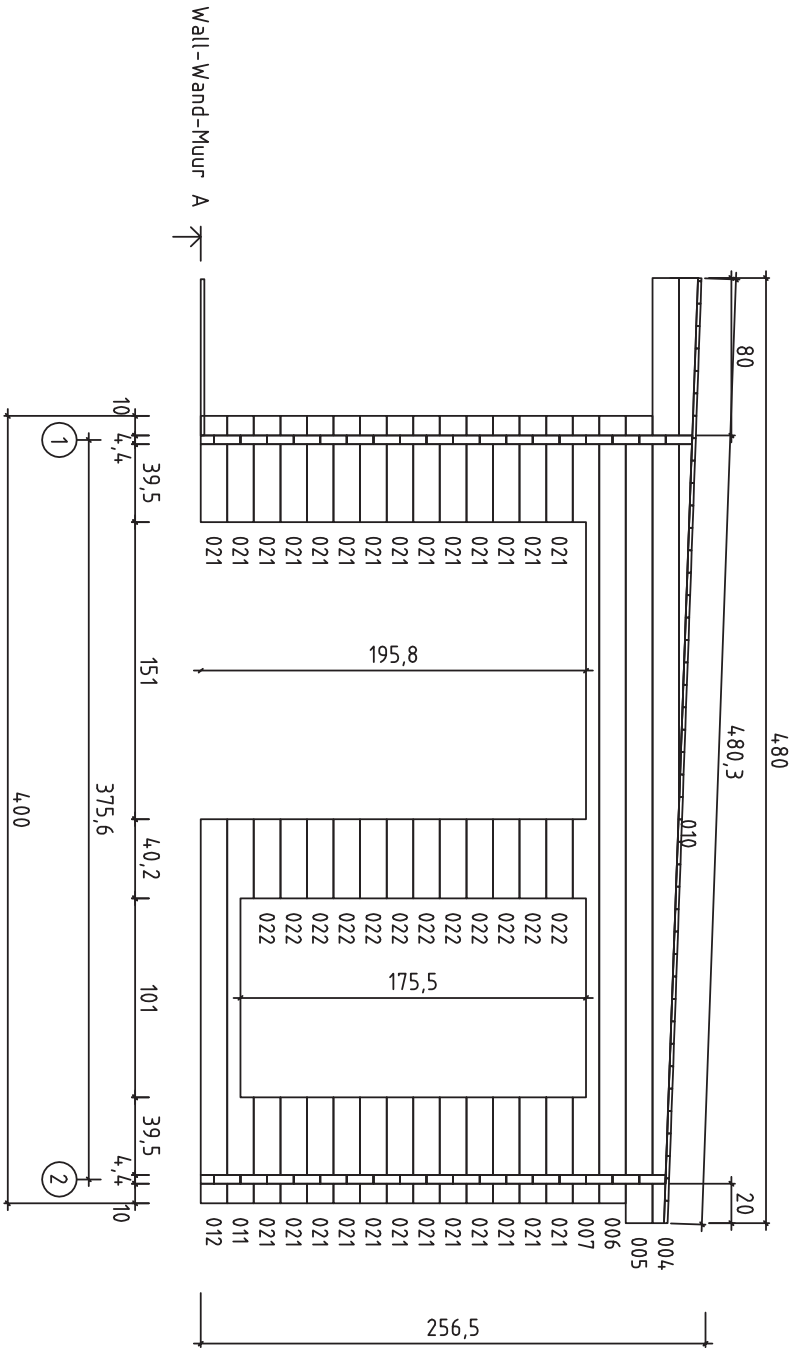

House	Sabrina - 44	Sheet	5
Drawing	WALL-WAND-MUUR A	Scale	1:35
Material	4,4 x 13,5	Date	19.02.2020
Drawer	K.K.	File	Sabrina - 44.dwg

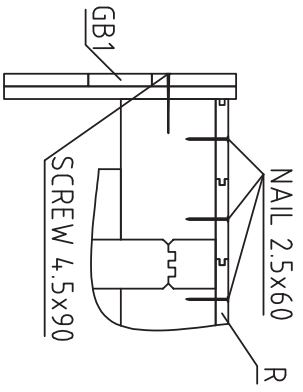
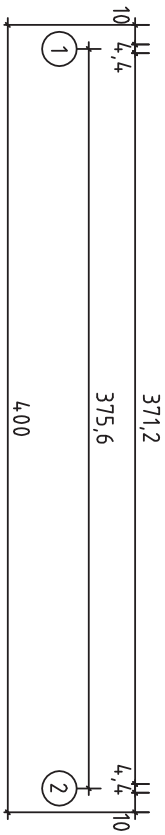
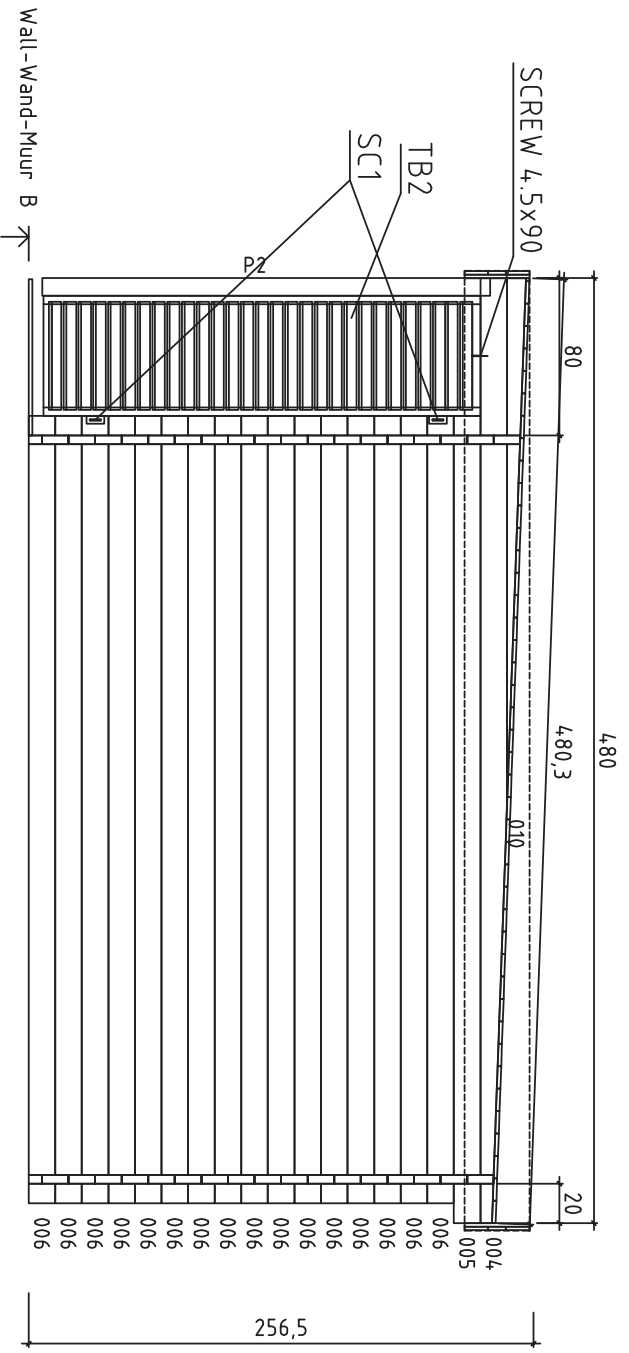

House	Sabrina - 44	Sheet	6
Drawing	WALL-WAND-MUUR B	Scale	1:35
Material	4.4 x 13.5	Date	19.02.2020
Drawer	K.K.	File	Sabrina - 44.dwg

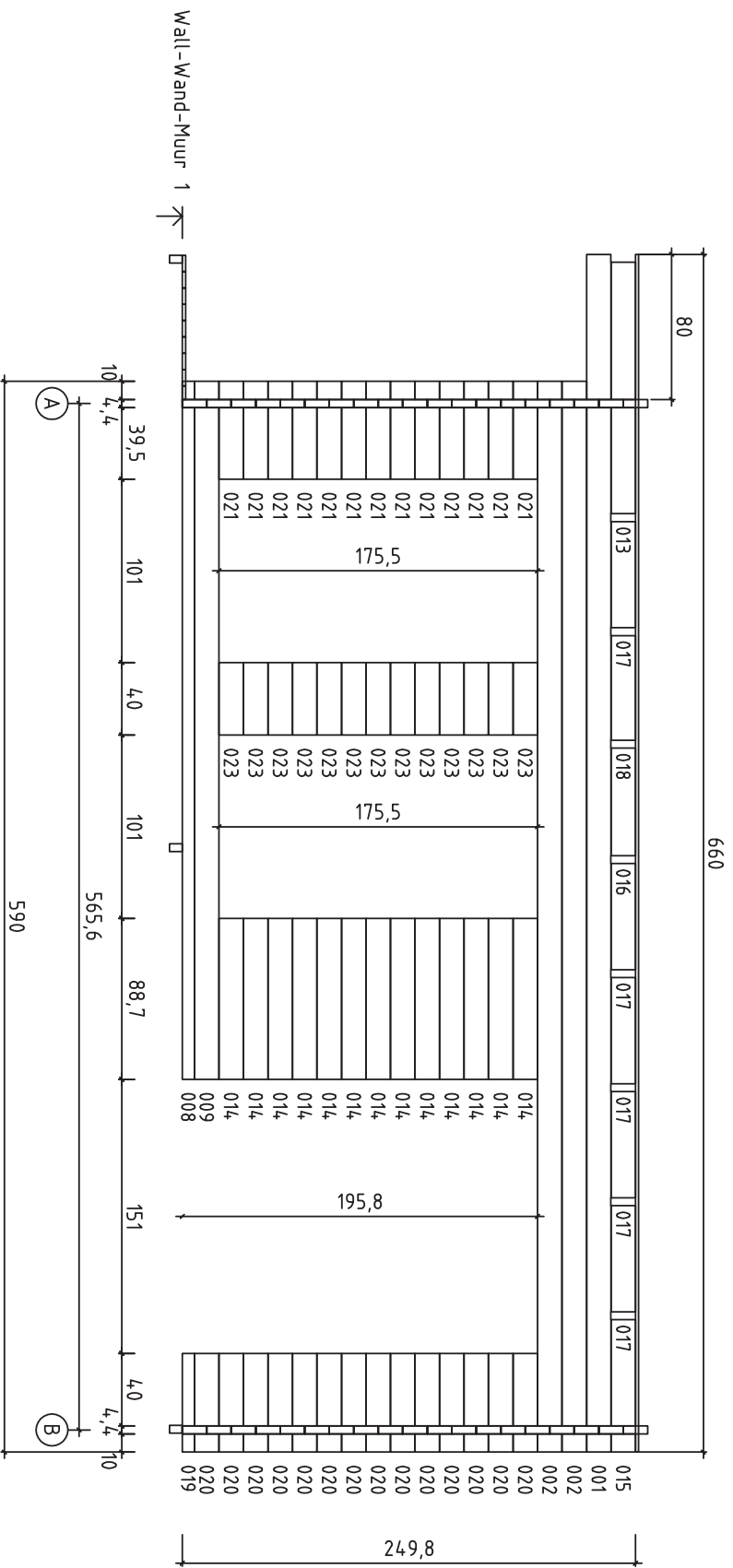

House	Sabrina - 44	Sheet	7
Drawing	WALL-WAND-MUUR 1	Scale	1:35
Material	4.4 x 13.5	Date	19.02.2020
Drawer	K.K.	File	Sabrina - 44.dwg

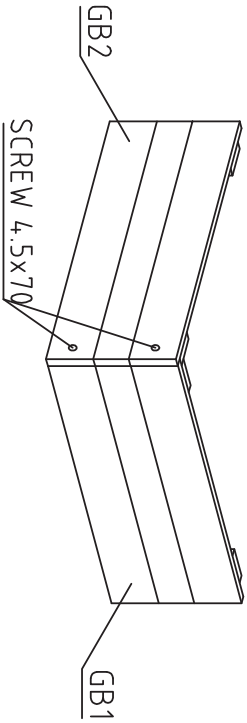
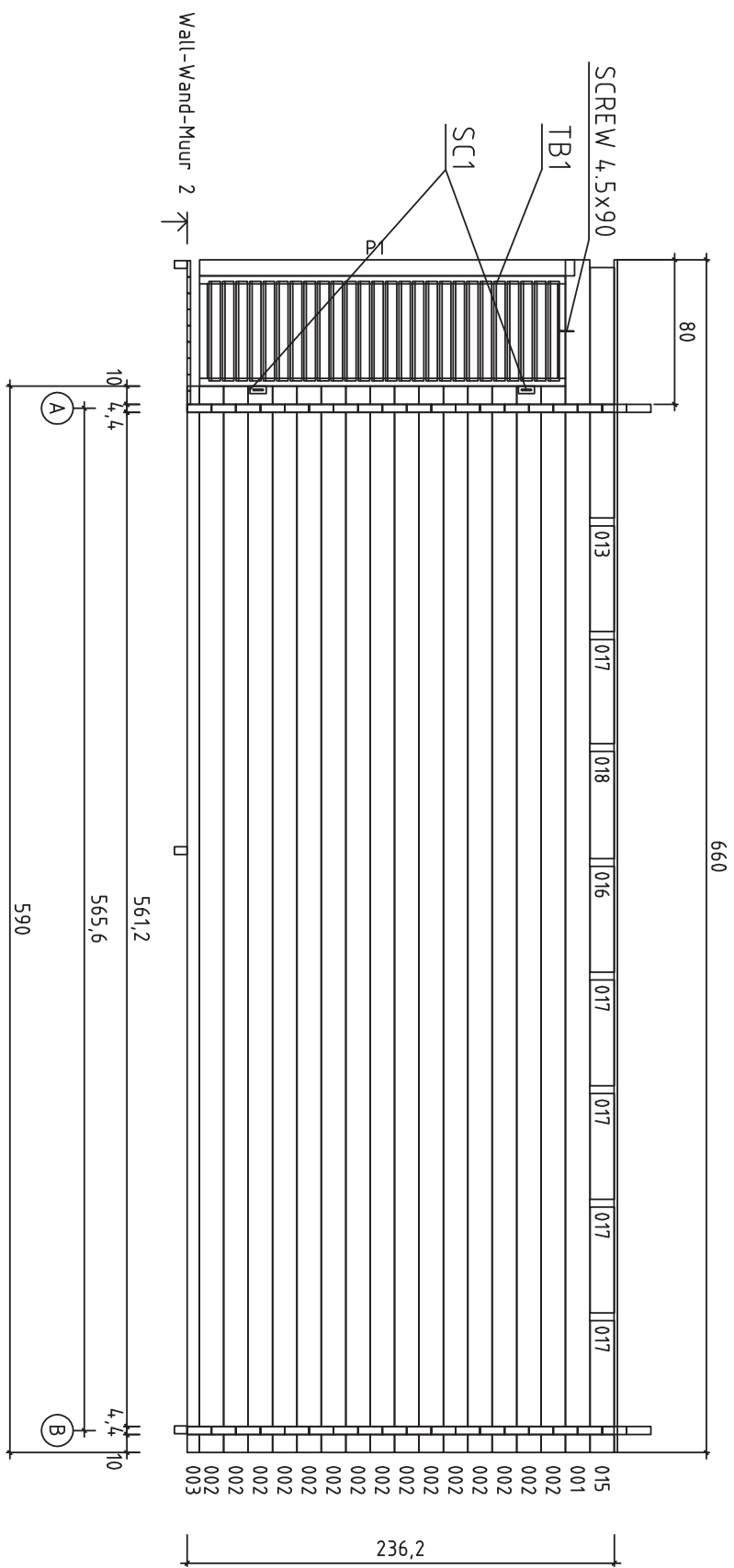





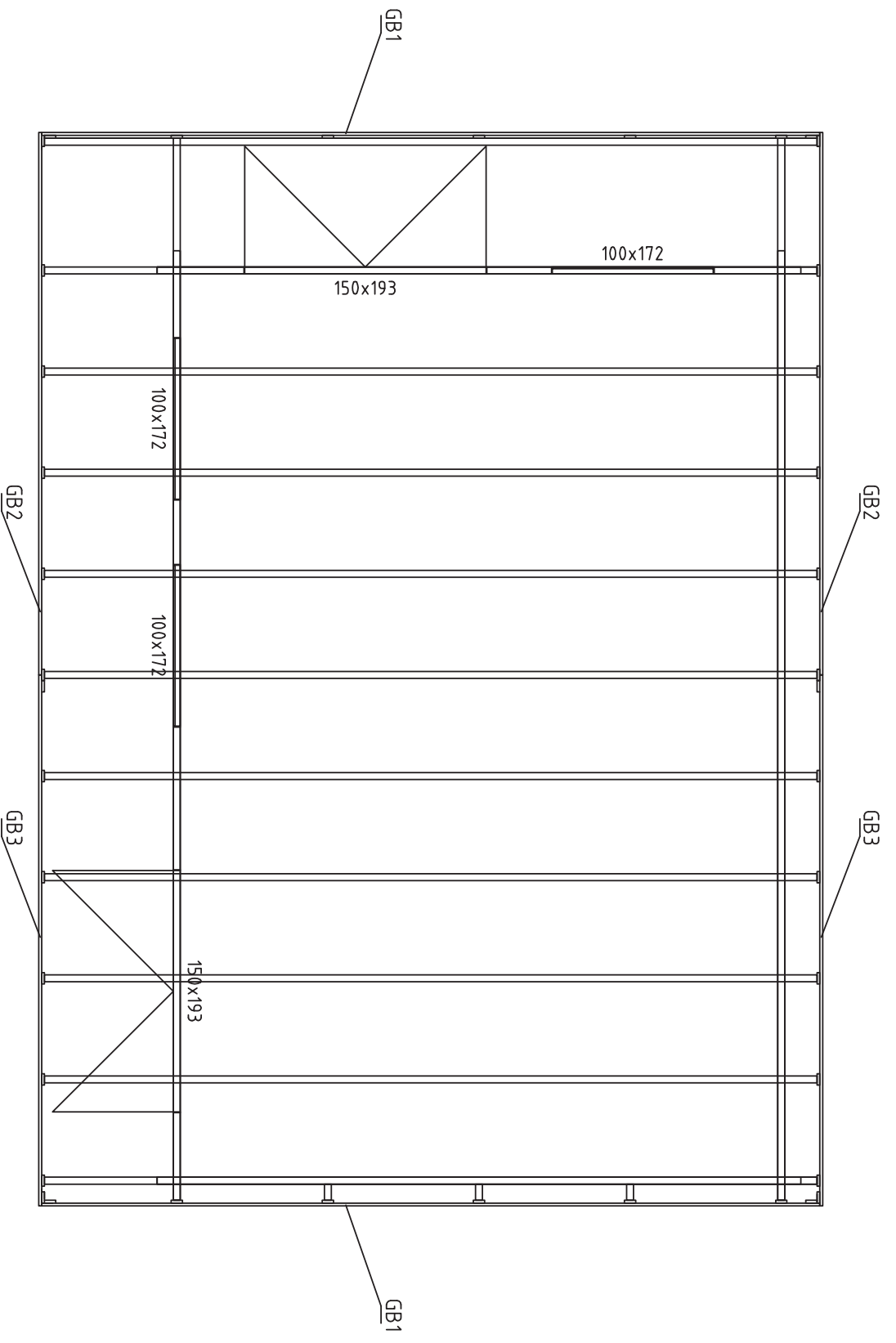



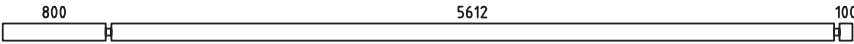
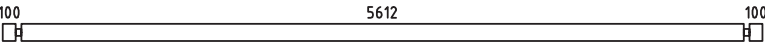
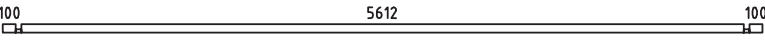
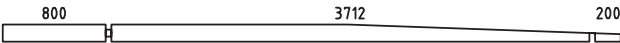
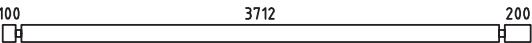
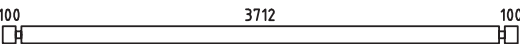
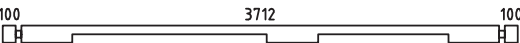
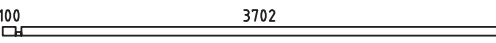
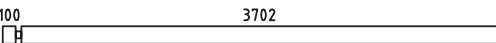

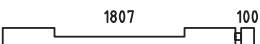
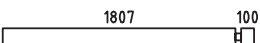
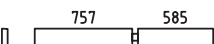

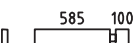









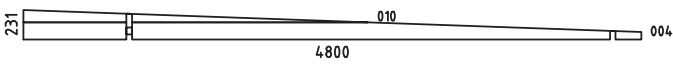

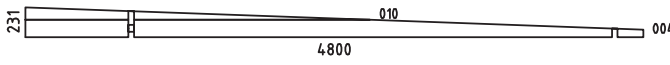
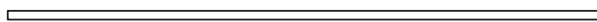
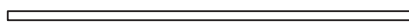



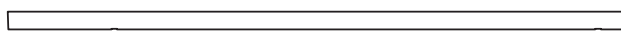



House	Sabrina - 4,4	Sheet	8
Drawing	WALL-WAND-MUUR 2	Scale	1:35
Material	4.4x13.5	Date	19.02.2020
Drawer	K.K.	File	Sabrina - 4.4.dwg

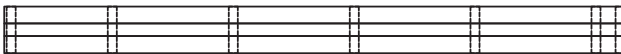
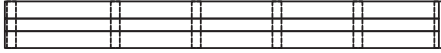
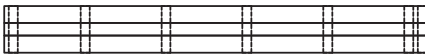













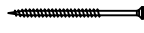

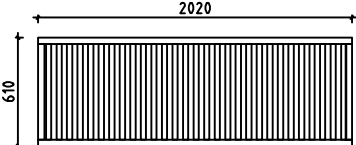
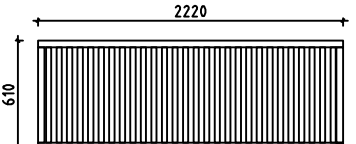
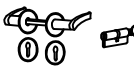
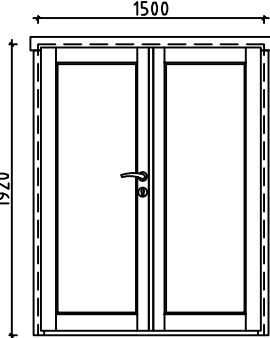

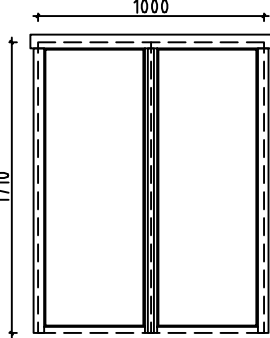
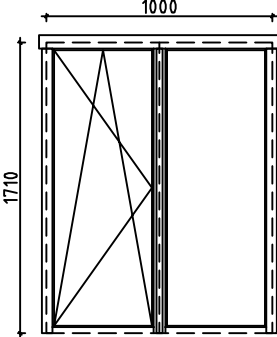

House	Sabrina - 44	Sheet	9
Drawing	Plan	Scale	1:35
Material		Date	19.02.2020
Drawer	K.K.	File	Sabrina - 44.dwg

Pos	Sabrina - 44	Pcs	Profile (mm)	L (mm)
001		2	44x135	6600
002		17+1	44x135	5900
003		1	44x68	5900
004		2	44x135	4800
005		2	44x135	4100
006		17	44x135	4000
007		1	44x135	4000
008		1	44x68	3846
009		1	44x135	3846
010		2	44x96	2678
011		1	44x135	1951
012		1	44x135	1951
013		2	44x135	1386
014		13	44x135	887
015		2	44x135	729
016		2	44x135	594
017		10	44x135	585
018		2	44x135	576
019		1	44x68	544
020		14	44x135	544
021		39	44x135	539
022		12	44x135	402
023		13	44x135	400
HB	HIT BLOCK-SCHLAGHÖLZER 	2	44x135	300
WA-1		1	44x231	4800
Kood	Sabrina - 44	Materjal	File Sabrina - 44.dwg	Leht 10

Pos	Sabrina - 44		Pcs	Profile (mm)	L (mm)	
WB-1			1	44x231	4800	
FBI1	FLOORBEAMS-FUSSBODENBALKEN 		IMM 4	43x70	4590	
FBI3	FLOORBEAMS-FUSSBODENBALKEN 		IMM 24	43x70	3160	
FBI2	FLOORBEAMS-FUSSBODENBALKEN 		IMM 4	43x70	484	
P2	POST-POST-POST 		1	90x90	2270	
P1	POST-POST-POST 		1	90x90	2070	
RB1	ROOFBEAMS-DACHBALKEN 		9	43x140	4808	
F1	FLOORBOARD-FUSSBODENBRETT		or-oder-of	65+1 50+1	18x88 18x114	3710
T1	TERRACE BOARD-TERRASSENBRETT-TERRASSPLANK		IMM	9	18x90	4595
T2	TERRACE BOARD-TERRASSENBRETT-TERRASSPLANK		IMM	64	18x90	795
R1	ROOFBOARD-DACHBRETT		or-oder-of	56+1 43+1	18x88 18x114	3900
R2	ROOFBOARD-DACHBRETT		or-oder-of	56+1 43+1	18x88 18x114	2700
FF1	FLOOR FILLET-FUSSBODENLEISTE-VLOERPLINT				18x35	19.0
ASSEMBLY REQUIRED-MONTAGE ERFORDERLICH-MONTAGE VEREIST GB1 - GB3						
GB1			2	36x330	4836	
GB2			2	36x330	3406	
GB3			2	36x330	3300	
KT1	ASSEMBLING BOARD-MONTAGE BOARD-MONTAGE PLANK		3	45x90	100	
SS1 SS2	STORM SLAT-STURMLEISTE-STORMLIJST		2 2	18x35	2250 2350	
PR	POST REGULATOR-PFOSTEN REGLER-STUT REGELAAR		2			
SC1	STEEL CORNER-STAH ECKE-STALEN HOEK		4	35x130	35	
	SCREWS-SCHRAUBEN-SCHROEF FOR-FÜR-VOOR	SC1		4	ø6.0	40
	NAIL-NAGEL-NAGEL FOR-FÜR-VOOR	FF1		16	ø2.0	40
	NAIL-NAGEL-NAGEL FOR-FÜR-VOOR	F1, R1, T1, T2		1480	ø2.5	60
	SCREWS-SCHRAUBEN-SCHROEF FOR-FÜR-VOOR	SC1		8	ø3.5	35
Kood	Sabrina - 44	Materjal	File	Sabrina - 44.dwg	Leht	11

Pos	Sabrina - 44	Pcs	Profile (mm)	L (mm)	
	SCREWS-SCHRAUBEN-SCHROEF FOR-FÜR-VOOR SS1		12	φ6.0	50
	WASHER-SCHEIBE-SCHIJF FOR-FÜR-VOOR SC1, SS1		16	φ6.0	18
	SCREWS-SCHRAUBEN-VIS FOR-FÜR-POUR GB1 - GB3		240	φ3.5	35
	SCREWS-SCHRAUBEN-SCHROEF FOR-FÜR-VOOR GB1, GB2, GB3		17	φ4.5	70
	SCREWS-SCHRAUBEN-SCHROEF FOR-FÜR-VOOR TB1, TB2, GB1, GB2, GB3 003, 008, 019		48	φ4.5	90
	SCREWS-SCHRAUBEN-SCHROEF FOR-FÜR-VOOR FBI1, FBI2, FBI3, FBI4		50	φ5.0	120
	SCREWS-SCHRAUBEN-SCHROEF FOR-FÜR-VOOR RB1		18	φ6.0	160
TB1		1	70x610	2020	
TB2		1	70x610	2220	
	DOUBLEDOR-DOPPELTÜR-DUBBELE DEUR (left-links-links) AST_PRE		V 2	1500	1920
			2		
			12		
	WINDOW-FENSTER-VENSTER (closed-feststehend-gesloten) AST_PRE_K		2	1000	1710
					
	WINDOW-FENSTER-VENSTER (right-rechts-rechts) AST_PRE_K		P 1	1000	1710
Kood	Sabrina - 44	Materjal	File	Sabrina - 44.dwg	Leht 12

Pos	Assembly Instructions-Montageanleitungen-Montage-instructies	Pcs	Profile (mm)	L (mm)
L1	BOARD-BRETT-BORD 	4	18x120	4836
L2	BOARD-BRETT-BORD 	4	18x120	3371
L3	BOARD-BRETT-BORD 	4	18x120	3300
L4	BOARD-BRETT-BORD 	2	18x90	4836
L5	BOARD-BRETT-BORD 	2	18x90	3371
L6	BOARD-BRETT-BORD 	2	18x90	3300
L7	BOARD-BRETT-BORD 	40	18x70	330

GB1 2 36x330 4836

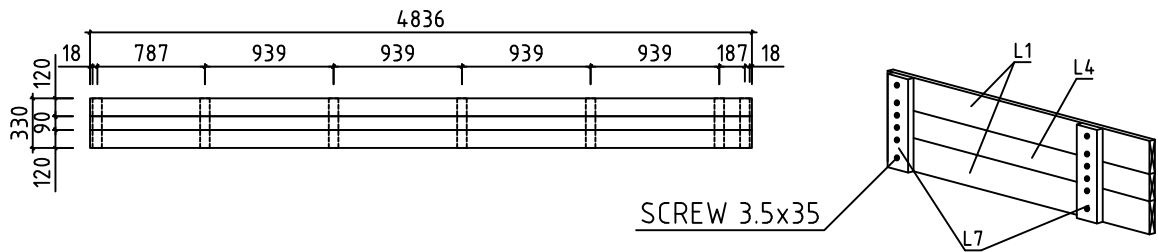

GB2 2 36x330 3406

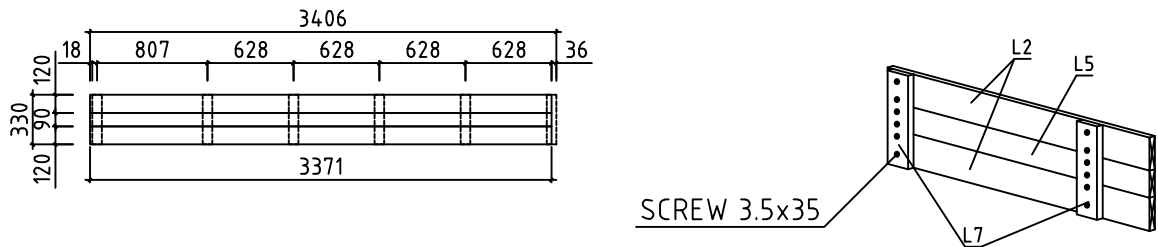

GB3 2 36x330 3300

