

Date rev. Description

V 1.0

House	Sabrina - 70	Sheet	1
Drawing	3D	Scale	
Material	70x135	Date	18.09.2019
Drawer	K.K.	File	Sabrina - 70 3D.dwg

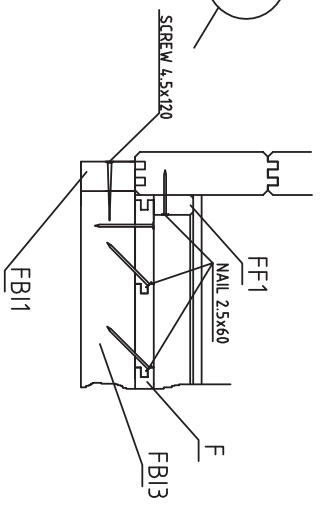
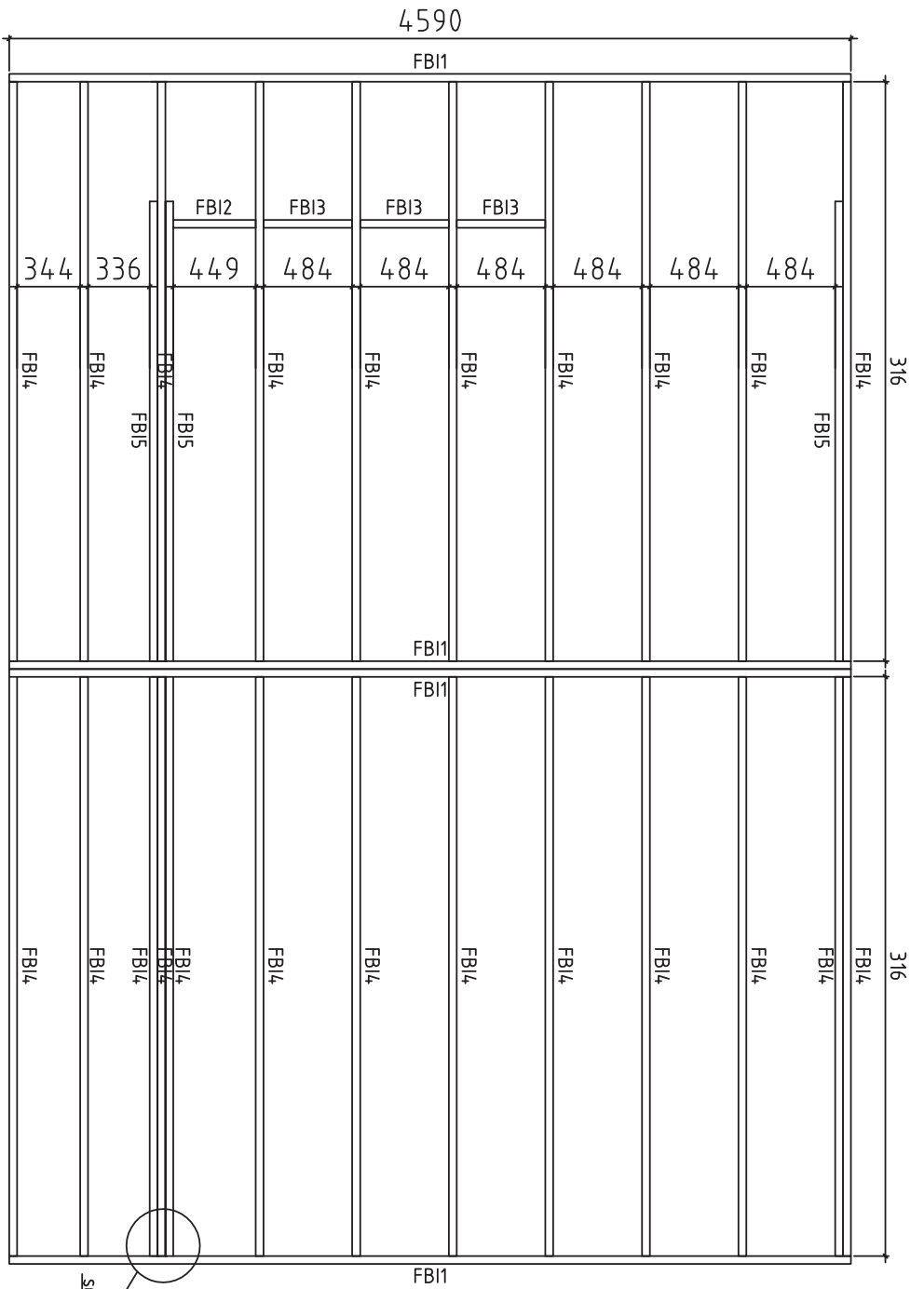

House	Sabrina - 70	Sheet	2
Drawing	Plan	Scale	1:35
Material	4,3x70	Date	08.04.2020
Drawer	K.K.	File	Sabrina - 70.dwg

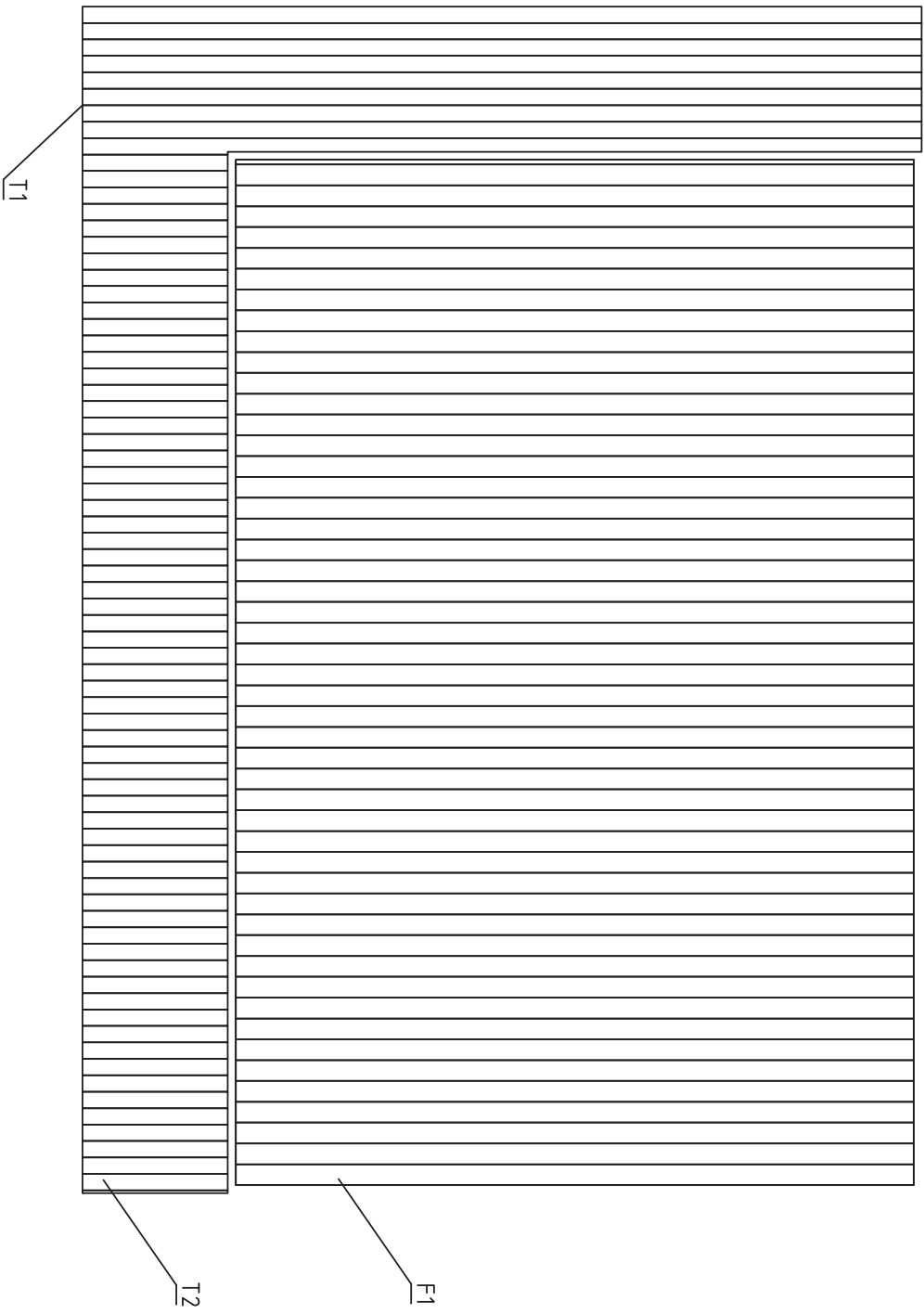

House	Sabrina - 70	Sheet	3
Drawing	Plan	Scale	1:35
Material	4,4x135	Date	08.04.2020
Drawer	K.K.	File	Sabrina - 70.dwg

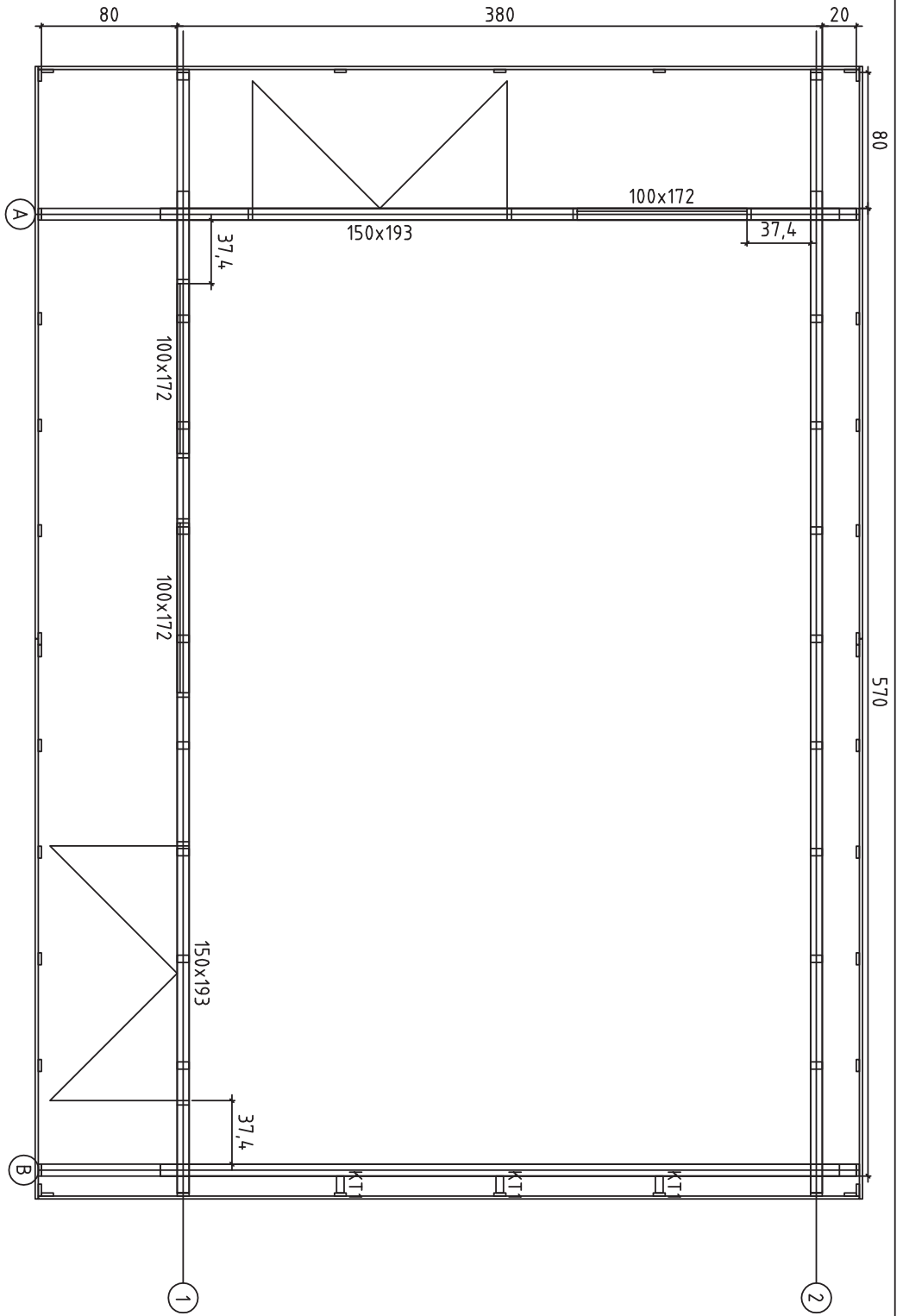

House	Sabrina - 70	Sheet	4
Drawing	Plan	Scale	1:35
Material	7.0x135	Date	08.05.2020
Drawer	K.K.	File	Sabrina - 70.dwg

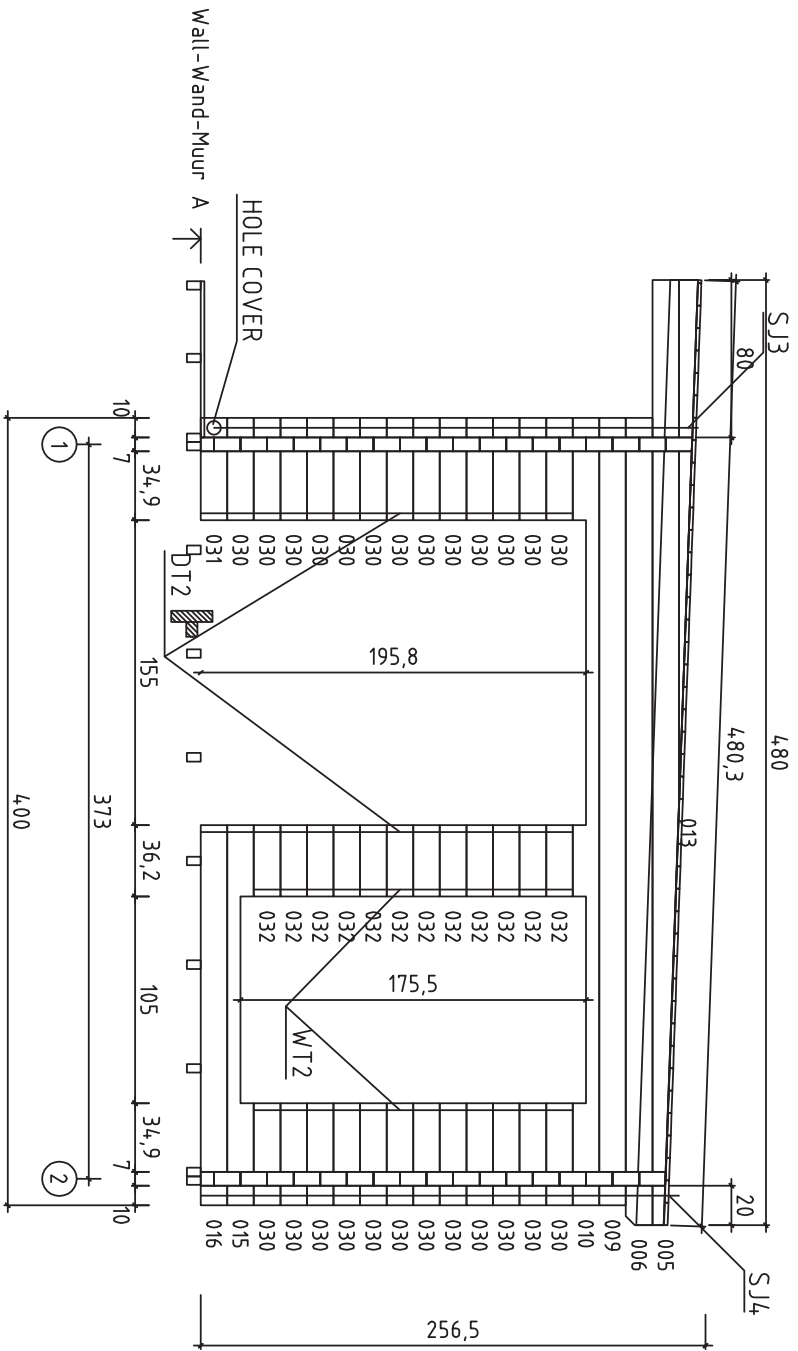

House	Sabrina - 70	Sheet	5
Drawing	WALL-WAND-MUUR A	Scale	1:35
Material	7.0x13.5	Date	08.04.2020
Drawer	K.K.	File	Sabrina - 70.dwg

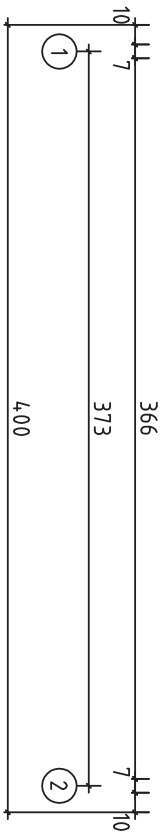
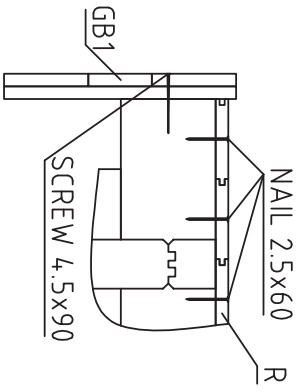
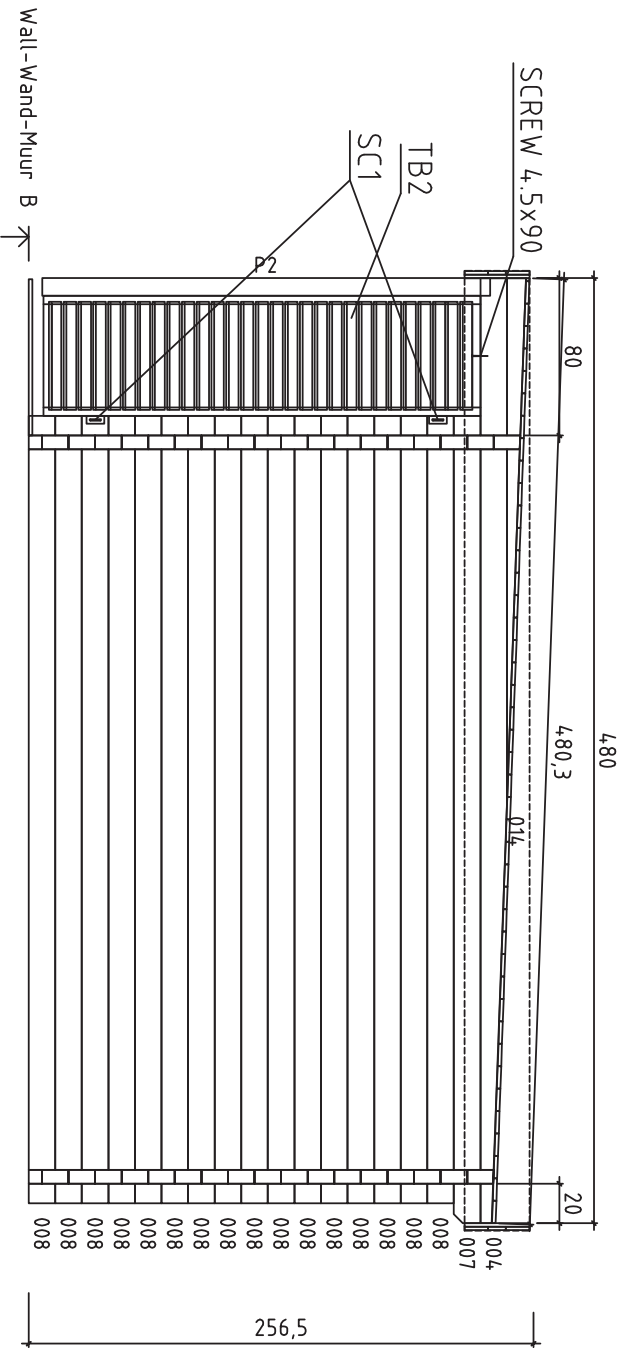

House	Sabrina - 70	Sheet	6
Drawing	WALL-WAND-MUUR B	Scale	1:35
Material	7.0x13.5	Date	08.04.2020
Drawer	K.K.	File	Sabrina - 70.dwg

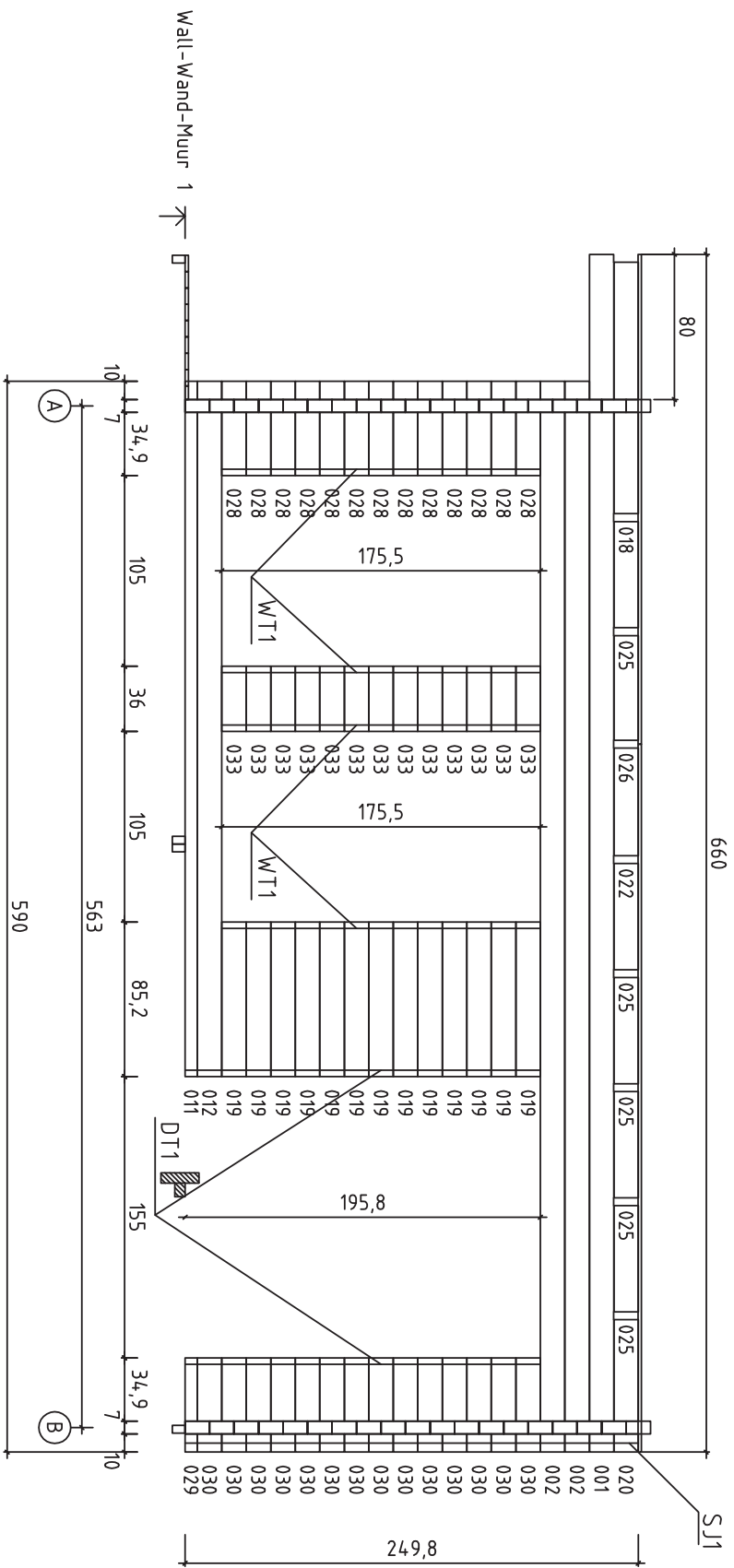



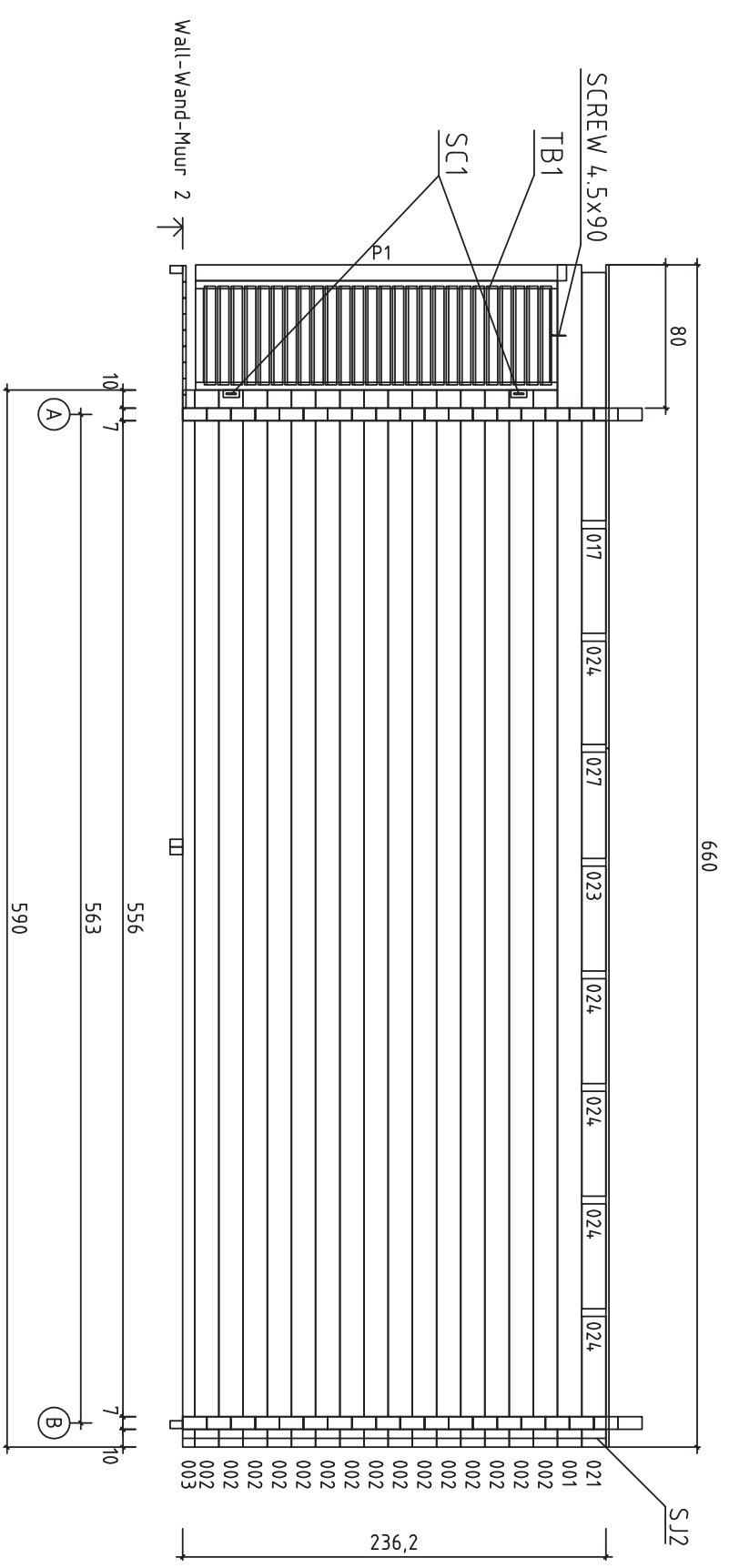



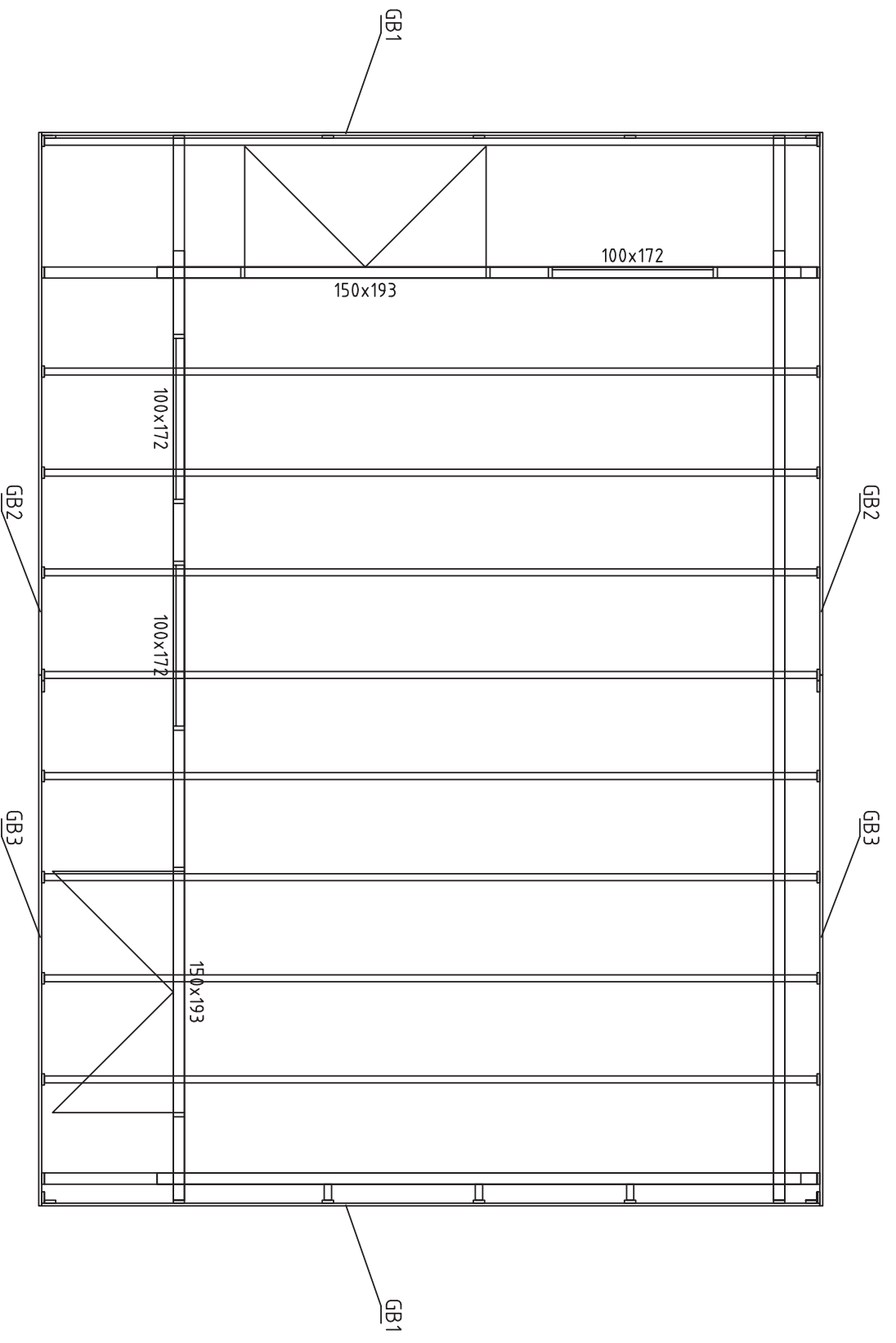

House	Sabrina - 70	Sheet	7
Drawing	WALL-WAND-MUUR 1	Scale	1:35
Material	7.0x13.5	Date	08.04.2020
Drawer	K.K.	File	Sabrina - 70.dwg

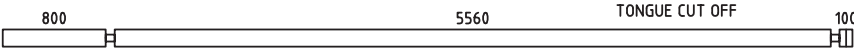
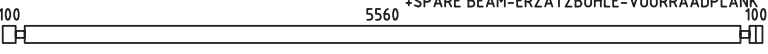
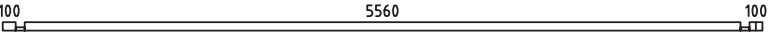
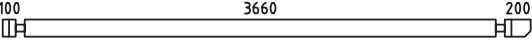
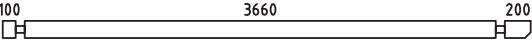
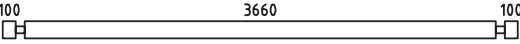
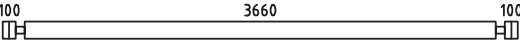
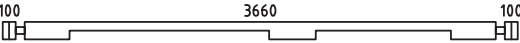
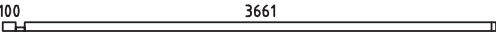
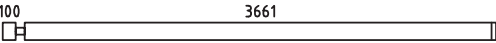
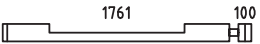
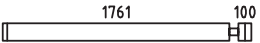
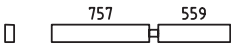
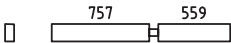
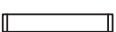
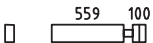
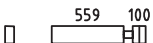













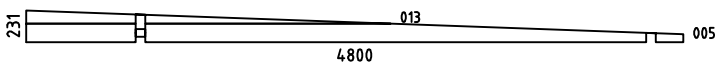
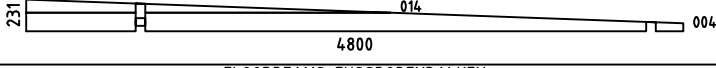





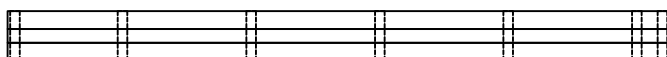

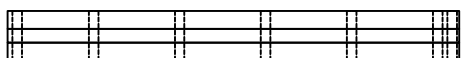









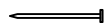

House	Sabrina - 70	Sheet	8
Drawing	WALL-WAND-MUUR 2	Scale	1:35
Material	7.0x13.5	Date	08.04.2020
Drawer	K.K.	File	Sabrina - 70.dwg





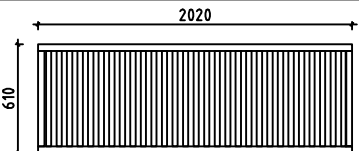
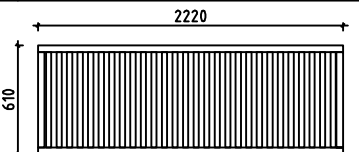



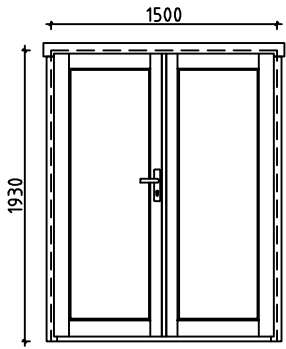
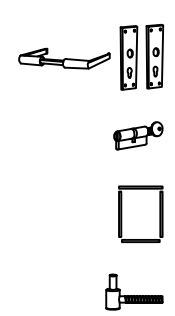
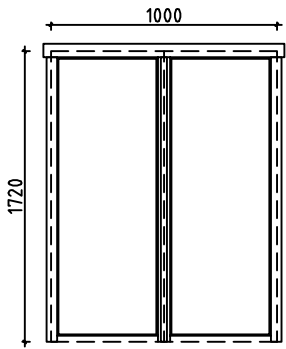
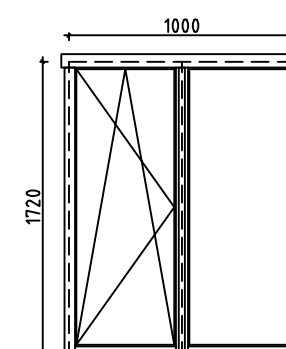
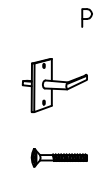

House	Sabrina - 70	Sheet	9
Drawing	Plan	Scale	1:35
Material		Date	08.04.2020
Drawer	K.K.	File	Sabrina - 70.dwg

Pos	Sabrina - 70	Pcs	Profile (mm)	L (mm)
001	 800 5560 TONGUE CUT OFF 100	2	70x135	6600
002	 100 5560 +SPARE BEAM-ERZATZBOHLE-VORRAADPLANK 100	17+1	70x135	5900
003	 100 5560 100	1	70x68	5900
006	 100 3660 200	1	70x135	4100
007	 100 3660 200	1	70x135	4100
008	 100 3660 100	16	70x135	4000
009	 100 3660 100	1	70x135	4000
010	 100 3660 100	1	70x135	4000
011	 100 3661	1	70x68	3831
012	 100 3661	1	70x135	3831
015	 1761 100	1	70x135	1931
016	 1761 100	1	70x135	1931
017	 757 559	1	70x135	1386
018	 757 559	1	70x135	1386
019		13	70x135	852
020	 559 100	1	70x135	729
021	 559 100	1	70x135	729
022		1	70x135	594
023		1	70x135	594
024		5	70x135	585
025		5	70x135	585
026		1	70x135	576
027		1	70x135	576
028	 100 349	13	70x135	519
029	 349 100	1	70x68	519
Kood	Sabrina - 70	Materjal	File Sabrina - 70.dwg	Leht 10

Pos	Sabrina - 70		Pcs	Profile (mm)	L (mm)	
030			39	70x135	519	
031		HOLE	1	70x135	519	
032			12	70x135	362	
033			13	70x135	360	
HB	HIT BLOCK-SCHLAGHÖLZER		2	70x135	300	
WA-1			1	70x231	4800	
WB-1			1	70x231	4800	
FBI1	FLOORBEAMS-FUSSBODENBALKEN		IMM	4	43x70	4590
FBI4	FLOORBEAMS-FUSSBODENBALKEN		IMM	23	43x70	3159
FBI5	FLOORBEAMS-FUSSBODENBALKEN		IMM	3	43x70	2507
FBI3	FLOORBEAMS-FUSSBODENBALKEN		IMM	3	43x70	484
FBI2	FLOORBEAMS-FUSSBODENBALKEN		IMM	1	43x70	449
P2	POST-POST-POST			1	90x90	2270
P1	POST-POST-POST			1	90x90	2070
RB1	ROOFBEAMS-DACHBALKEN			9	43x140	4808
F1	FLOORBOARD-FUSSBODENBRETT		or-oder-of	64+1 49+1	18x88 18x114	3650
T1	TERRACE BOARD-TERRASSENBRETT-TERRASSPLANK		IMM	9	18x90	4595
T2	TERRACE BOARD-TERRASSENBRETT-TERRASSPLANK		IMM	64	18x90	795
R1	ROOFBOARD-DACHBRETT		or-oder-of	56+1 43+1	18x88 18x114	3900
R2	ROOFBOARD-DACHBRETT		or-oder-of	56+1 43+1	18x88 18x114	2700
FF1	FLOOR FILLET-FUSSBODENLEISTE-VLOERPLINT				18x35	19.0
	ASSEMBLY REQUIRED-MONTAGE ERFORDERLICH-MONTAGE VEREIST GB1 - GB3					
GB1			2	36x330	4836	
GB2			2	36x330	3406	
GB3			2	36x330	3300	
Kood	Sabrina - 70	Materjal	File	Sabrina - 70.dwg	Leht 11	

Pos	Sabrina - 70		Pcs	Profile (mm)	L (mm)
KT1	ASSEMBLING BOARD-MONTAGE BOARD-MONTAGE PLANK		3	45x90	100
PR	POST REGULATOR-PFOSTEN REGLER-STUT REGELAAR		2		
SC1	STEEL CORNER-STAHL ECKE-STALEN HOEK		4	35x130	35
	SCREWS-SCHRAUBEN-SCHROEF FOR-FÜR-VOOR SC1		4	ø6.0	40
	WASHER-SCHEIBE-SCHIJF FOR-FÜR-VOOR SC1		4	ø6.0	18
SJ1	SCREW JOINT-GEWINDESTANGE -STELSCHROEF		1	M10	2540
SJ2	SCREW JOINT-GEWINDESTANGE -STELSCHROEF		1	M10	2420
SJ3	SCREW JOINT-GEWINDESTANGE -STELSCHROEF		1	M10	2470
SJ4	SCREW JOINT-GEWINDESTANGE -STELSCHROEF		1	M10	2400
	NAIL-NAGEL-NAGEL FOR-FÜR-VOOR FF1		16	ø2.0	40
	NAIL-NAGEL-NAGEL FOR-FÜR-VOOR F1, R1, T1, T2		1480	ø2.5	60
	SCREWS-SCHRAUBEN-SCHROEF FOR-FÜR-VOOR SC1, GB1 - GB3		248	ø3.5	35
	SCREWS-SCHRAUBEN-SCHROEF FOR-FÜR-VOOR GB1, GB2, GB3		17	ø4.5	70
	SCREWS-SCHRAUBEN-SCHROEF FOR-FÜR-VOOR TB1, TB2, GB1, GB2, GB3 003, 008, 019		48	ø4.5	90
	SCREWS-SCHRAUBEN-SCHROEF FOR-FÜR-VOOR FBI1, FBI2, FBI3, FBI4		50	ø5.0	120
	SCREWS-SCHRAUBEN-SCHROEF FOR-FÜR-VOOR RB1		18	ø6.0	160
TB1			1	70x610	2020
TB2			1	70x610	2220
DT1 DT2	DOOR ASSEMBLING PROFILE-TÜR INSTALLIERUNGSPROFIL		2 2	43x70	1930 1860
WT1 WT2	WINDOW ASSEMBLING PROFILE-FENSTER INSTALLIERUNGSPROFIL		4 2	43x70	1720 1600
	HOLE COVER-LOCH DECKEN-GAT DEKKEN		1		
Kood	Sabrina - 70	Materjal	File	Sabrina - 70.dwg	Leht 12

Pos	Sabrina - 70	Pcs	Profile (mm)	L (mm)
	<p>DOUBLEDOOR-DOPPELTÜR-DUBBELE DEUR (left-links-links) AST_ISO_PL V</p>  	2	1500	1930
	<p>WINDOW-FENSTER-VENSTER (closed-feststehend-gesloten) AST_ISO_K</p> 	2	1000	1720
	<p>WINDOW-FENSTER-VENSTER (right-rechts-rechts) AST_ISO_K</p>  	1	1000	1720
Kood	Sabrina - 70	Materjal	File	Sabrina - 70.dwg
		Leht	13	

Pos	Assembly Instructions-Montageanleitungen-Montage-instructies	Pcs	Profile (mm)	L (mm)
L1	BOARD-BRETT-BORD 	4	18x120	4836
L2	BOARD-BRETT-BORD 	4	18x120	3371
L3	BOARD-BRETT-BORD 	4	18x120	3300
L4	BOARD-BRETT-BORD 	2	18x90	4836
L5	BOARD-BRETT-BORD 	2	18x90	3371
L6	BOARD-BRETT-BORD 	2	18x90	3300
L7	BOARD-BRETT-BORD 	40	18x70	330

GB1 2 36x330 4836

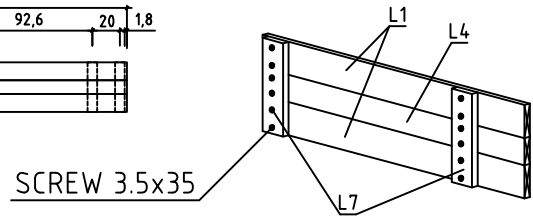
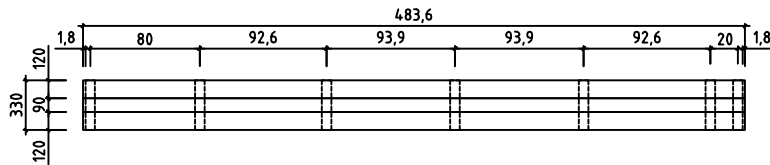

GB2 2 36x330 3406

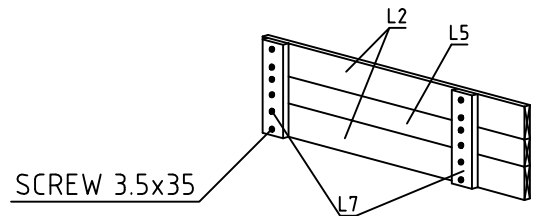
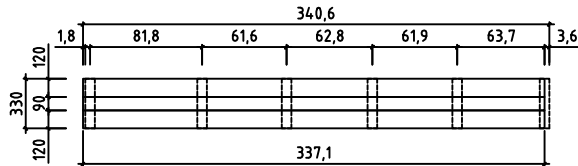

GB3 2 36x330 3300

