











Installation drawings DRESDEN CH183

marking			length	pcs	
WALLS					
extra	WALL LOG 70x146		5900	2	
001.	WALL LOG 70x146		5900	18	
001A	WALL LOG 70x146		5900	1	
001V2	WALL LOG 70x146		5900	1	
002.	WALL LOG 70x146		4800	4	
002C	WALL LOG 70x146		4800	2	
003.	WALL LOG 70x146		4195	2	
004.	WALL LOG 70x146		4000	18	
004C.	WALL LOG 70x146		4000	2	
004v1	WALL LOG 70x146		4000	2	
004v2	WALL LOG 70x146		4000	2	
005.	WALL LOG 70x146		2657	14	
006.	WALL LOG 70x146		2540	1	
006A	WALL LOG 70x146		2540	1	
006V1	WALL LOG 70x146		2540	1	
007.	WALL LOG 70x146		2540	2	
007A	WALL LOG 70x146		2540	1	
007V3	WALL LOG 70x146		2540	1	
008.	WALL LOG 70x146		2460	3	
009.	WALL LOG 70x146		2405	2	
029.	WALL LOG 70x146		1949	2	
010.	WALL LOG 70x146		1714	1	
010A	WALL LOG 70x146		1714	1	
010V1	WALL LOG 70x146		1714	1	
011.	WALL LOG 70x146		1290	2	
012.	WALL LOG 70x146		1042	15	
013.	WALL LOG 70x146		1058	2	
014.	WALL LOG 70x146		742	15	

015.	WALL LOG 70x146		687	12	
016.	WALL LOG 70x146		687	12	
017.	WALL LOG 70x146		666	2	
018.	WALL LOG 70x146		666	2	
020.	WALL LOG 70x146		587	14	
022.	WALL LOG 70x146		498	4	
023.	WALL LOG 70x146		498	2	
024.	WALL LOG 70x146		490	8	
019.	WALL LOG 70x146		405	28	
021.	WALL LOG 70x146		378	13	
025.	WALL LOG 70x146		331	12	
026.	WALL LOG 70x146		217	12	
027.	UNDER THE DOOR 70x15		1590	2	
	HAMMER BLOCK 70 MM			2	
FLOOR					
AR-1	45x120 FLOOR FRAME		4570	1	
AR-1B	45x120 FLOOR FRAME		4570	1	
AR-2	45x120 FLOOR FRAME		4122	9	
AR-3	45x120 FLOOR FRAME		3705	2	
AR-4	45x120 FLOOR FRAME		3190	8	
AR-5	45x95 FLOOR FRAME		2212	2	
AR-6	45x120 FLOOR FRAME		2212	12	
AR-7	45x120 FLOOR FRAME		1800	2	
AR-8	45x120 FLOOR FRAME		471	7	
PL-1	28x120 FLOOR BOARD (FRONT ROOM)		3655	30+4	
PL-2	28x120 FLOOR BOARD (SAUNA ROOM)		1965	20+3	
PL-3	28x120 FLOOR BOARD (WASH ROOM)		1555	20+3	
TR-1	28x120 DECKING BOARD		4600	7+1	
TR-2	28x120 DECKING BOARD		800	47+3	

SCREWS AND NAILS					
	TREADED ROD M10		2000	6	
	TREADED ROD M10		680	3	
	TREADED ROD M10		540	3	
	LENGTHENING BOLT FOR TREADED ROD			6	
	DRIVE NUT FOR TREADED ROD			6	
	PLAIN WASHER FOR TREADED ROD			6	
	NUT FOR TREADED ROD			6	
	SLIDING BRACKET 35x35x130 FOR GRID WALL			6	
	WASHER M5 FOR GRID WALL			6	
	L-BRACKET 90x90 FOR FLOOR FRAME / ROOF EDGE			20	
	BEAM BRACKET 45x97 FOR FLOOR FRAME			10	
	POST HEIGHT ADJUSTMENT			2	
	SCREW 3,5x40 FOR MOULDINGS			400	
	SCREW 4,5x70 FOR ROOF EDGE BOARDS			300	
	SCREW 5x90 FOR FLOOR FRAME			200	
	SCREW 4,2x55 FOR FLOOR BOARDS			600	
	SCREW 4,2x55 FOR DECKING BOARDS			500	
	SCREW 4,5x80 FOR BENCH SUPPORTS, POST,			200	
	SCREW 6x180 FOR RAFTERS AND WALL CONNECTIONS			150	
	SCREW 5x40 FOR METAL BRACKETS			200	
	NAIL 75 MM FOR ROOF BOARDS			~200	
	NAIL 40 MM FOR CEILING BOARDS			~1200	
ROOF COVERING					
	SBS BITUMEN UNDERLAYER (15m2)	37m2		3	
	SBS BITUMEN TOP LAYER (10m2)	37m2		4	

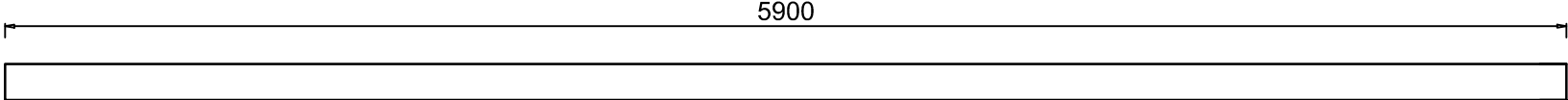
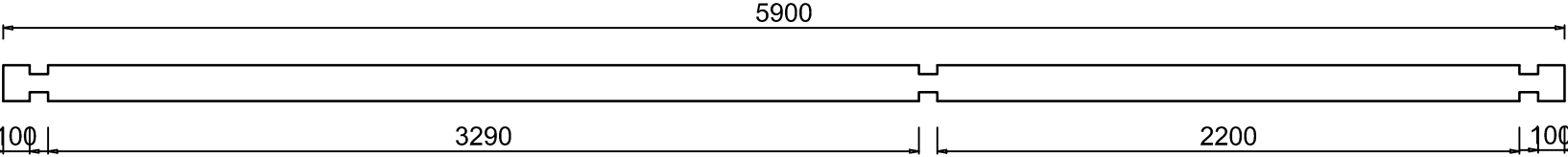
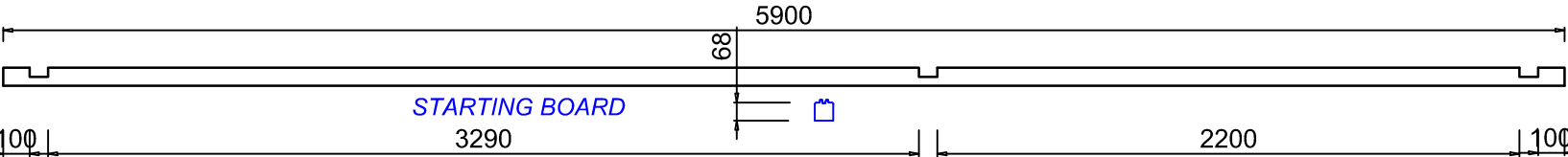
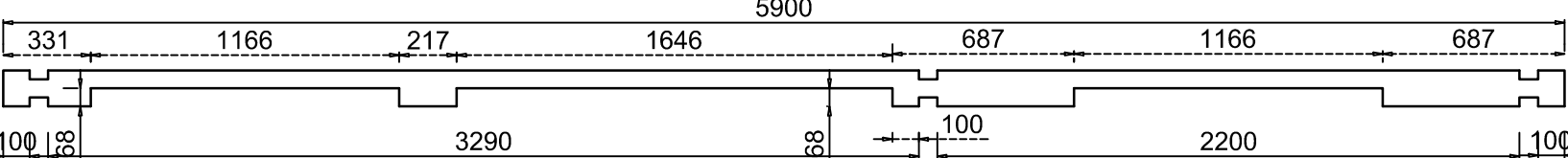
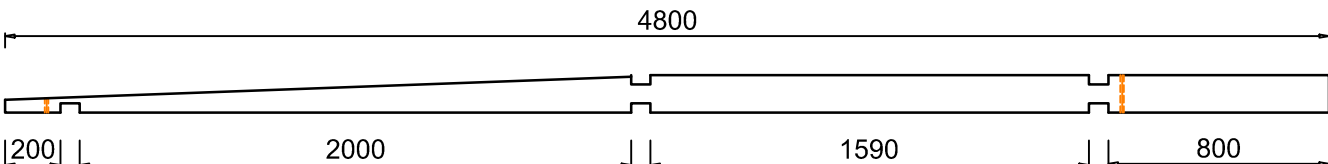
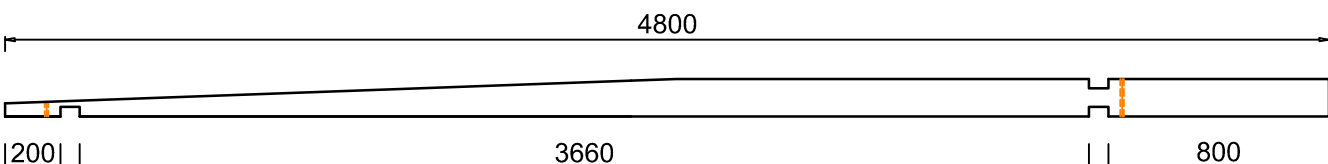
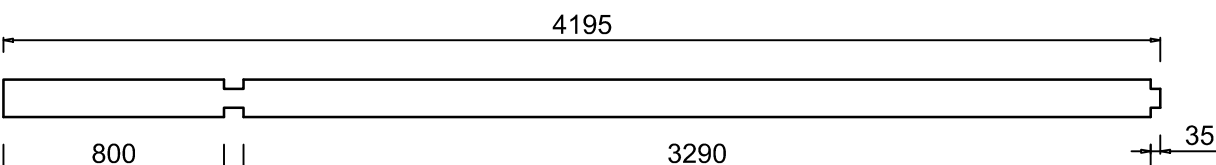
EXTRA	2 pcs	
001	18 pcs	
001A	1 pcs	
001v2	1 pcs	
002	4 pcs	
002C	2 pcs	
003	2 pcs	

004	18 pcs	
004C	2 pcs	
004v1	1 pcs	
004v2	1 pcs	
005	14 pcs	
006	1 pcs	
006A	1 pcs	

006v1	1 pcs	<p>2540 687 1166 687 100 2200 68 100</p>
007	2 pcs	<p>2540 100 2200 100</p>
007A	1 pcs	<p>2540 68 100 2200 100 STARTING BOARD</p>
007v3	1 pcs	<p>2540 666 498 498 666 100 70 2200 100</p>
008	3 pcs	<p>2460 800 1590</p>
009	2 pcs	<p>2405 35 100 2200</p>

029	2 pcs	
010	1 pcs	
010A	1 pcs	
010v1	1 pcs	
011	2 pcs	
012	15 pcs	
013	2 pcs	
014	15 pcs	
015	12 pcs	
016	12 pcs	

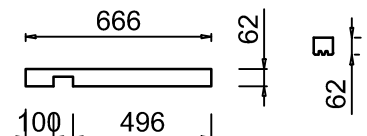
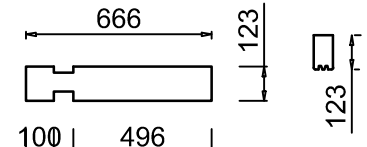
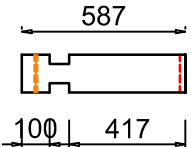
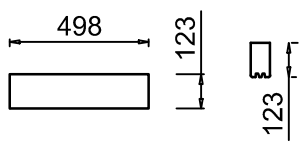
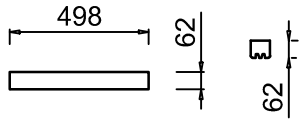
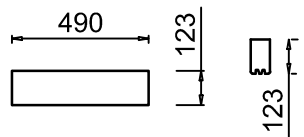
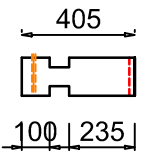
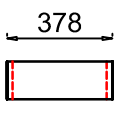
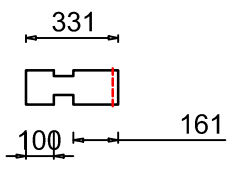
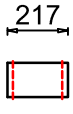
017	2 pcs	
018	2 pcs	
020	14 pcs	
022	4 pcs	
023	2 pcs	
024	8 pcs	
019	28 pcs	
021	13 pcs	
025	12 pcs	
026	12 pcs	

TOP VIEW

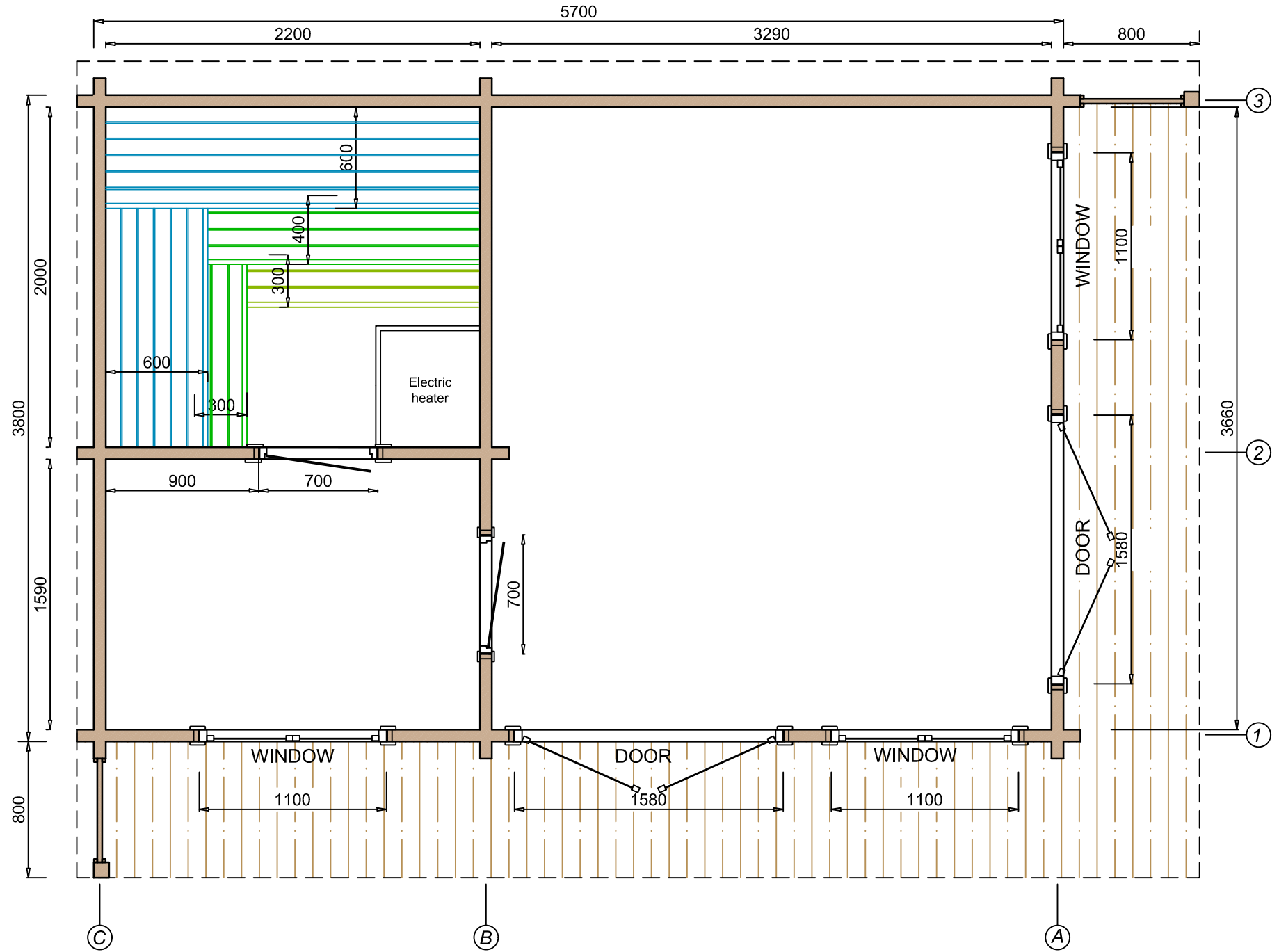

CROSS-SECTION

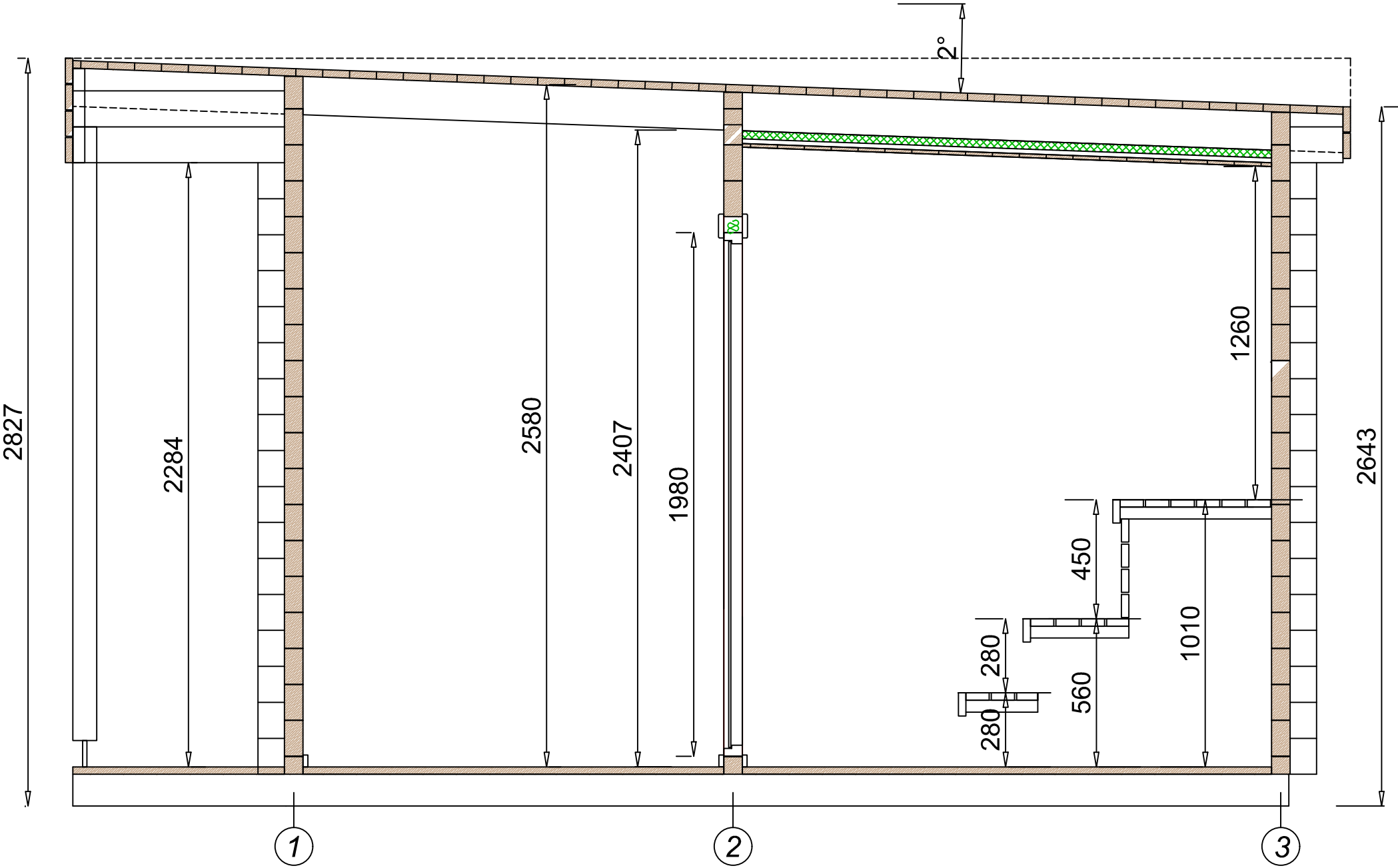

RIGHT VIEW

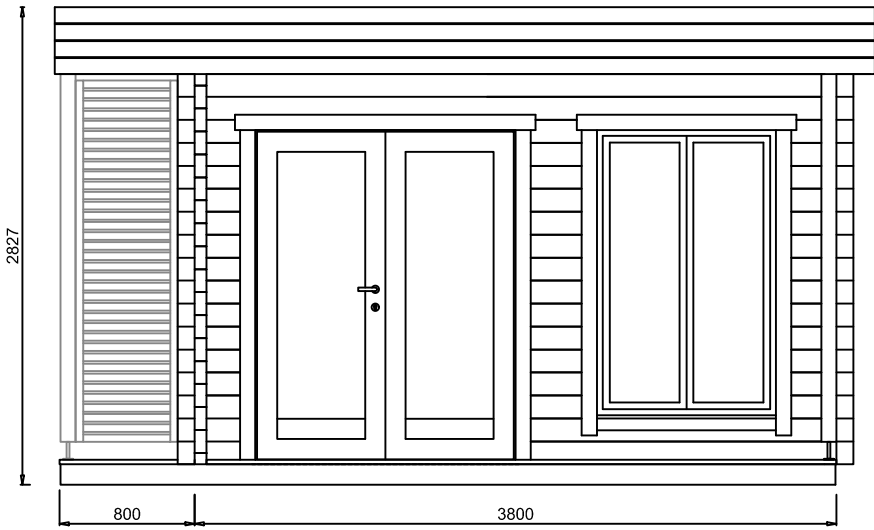

FRONT VIEW

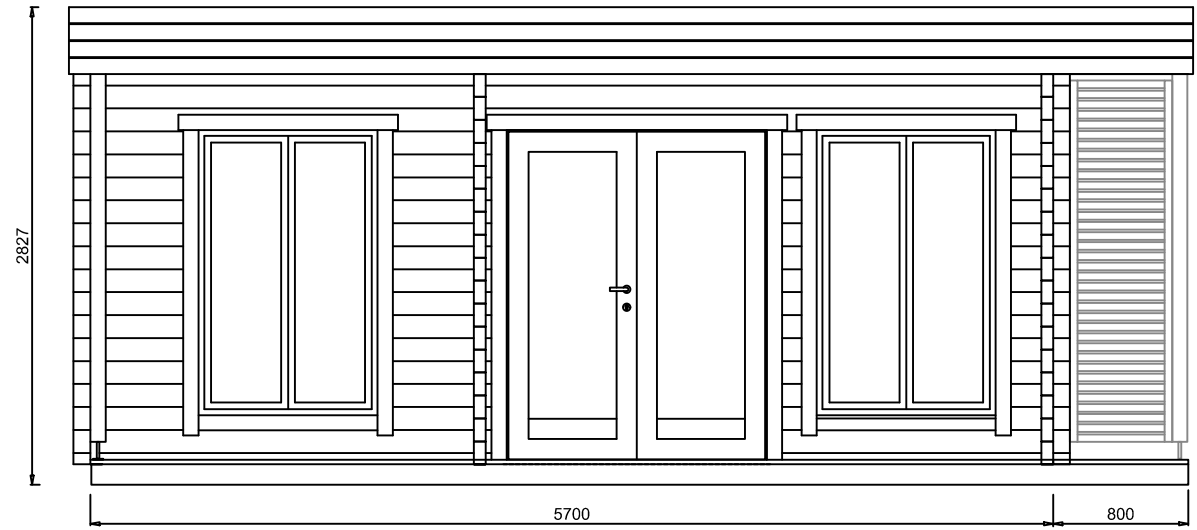

LEFT VIEW

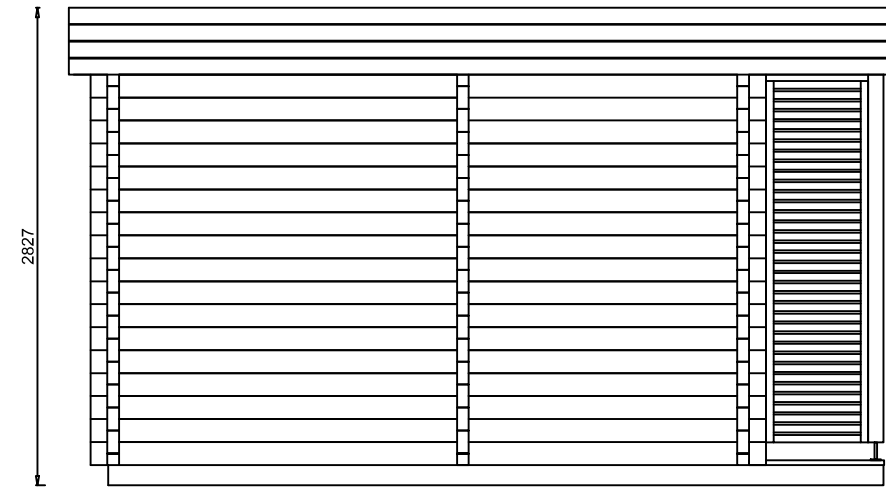

BACK VIEW

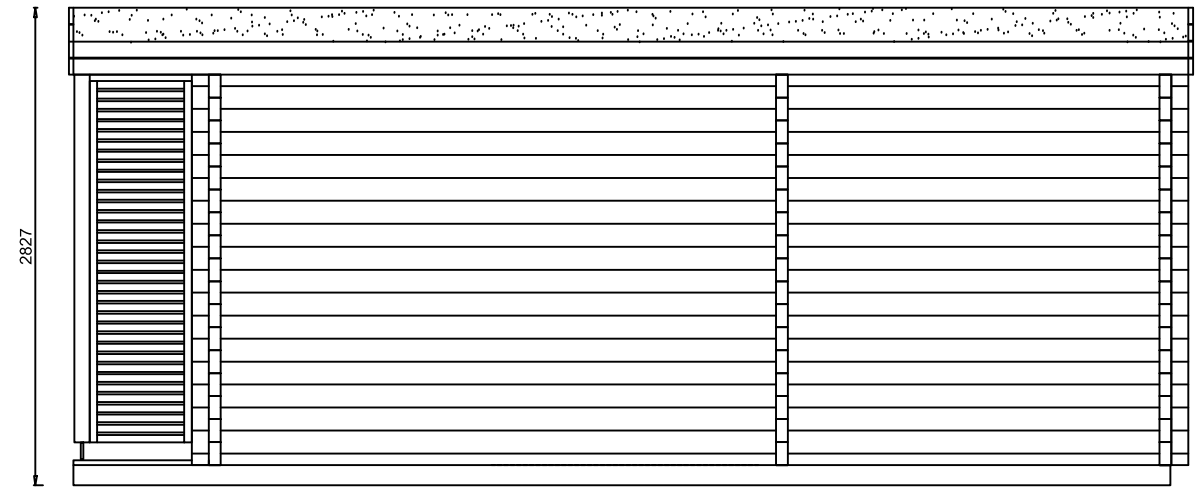

FLOOR FRAME 45x120

Opening 45x25
for water drainage

25

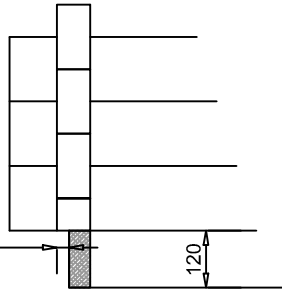

Opening 45x25
for water drainage

Fix the details together
with 90 mm screws

Use beam brackets (10pcs)
to fix the details in places
where can not use screws



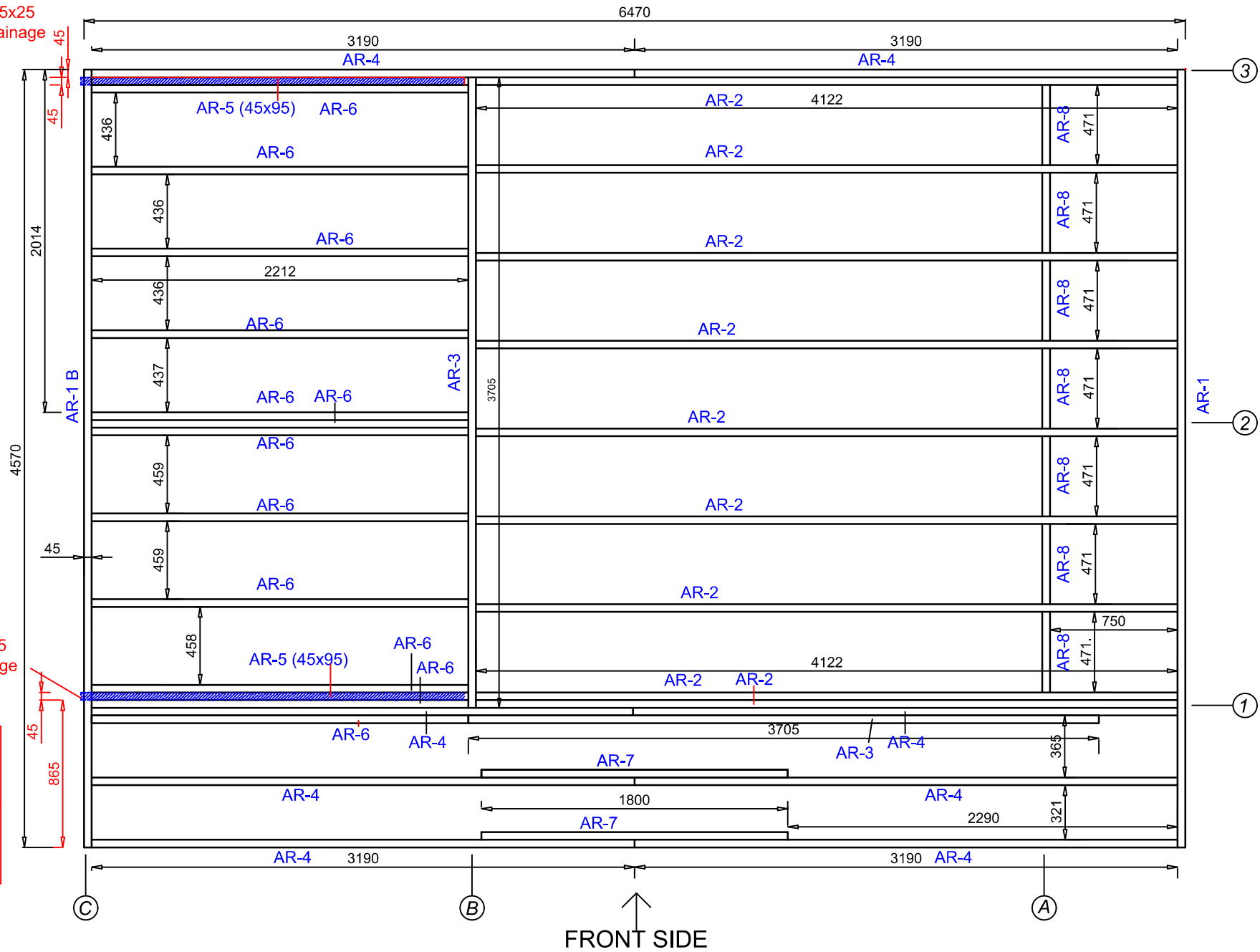

FLOOR FRAME

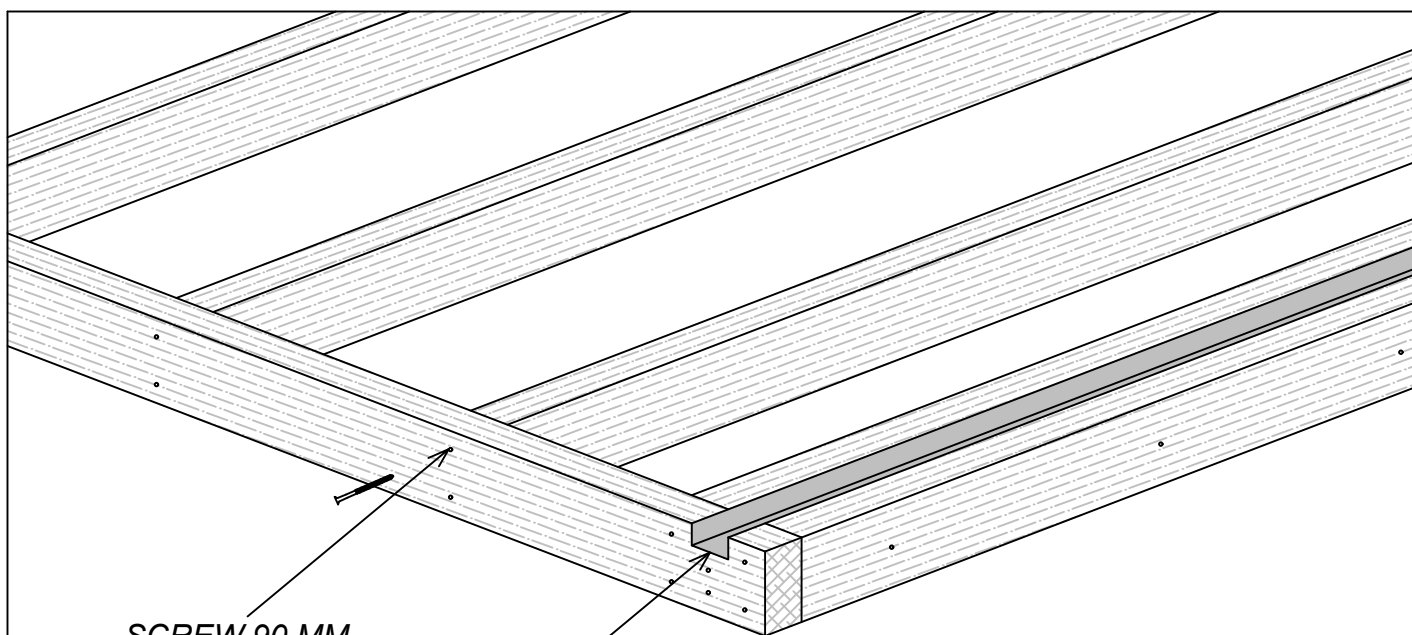

SCREW 90 MM

CUTOUT 45x25
FOR WATER DRAINAGE

INSTALL THE WATER DRAINAGE DETAIL BEFORE FLOOR BOARDS
FIX WITH FLOOR MOULDING

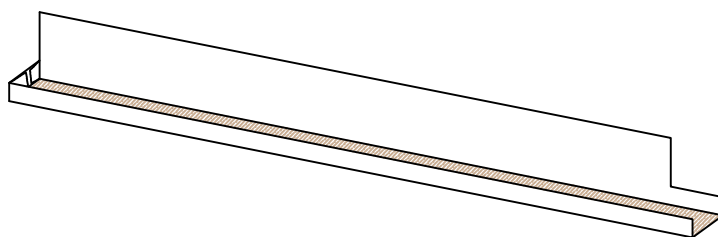

FIRST ROW

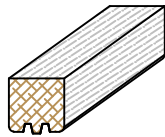
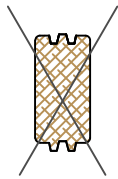

Use rubber hammer and hammer block

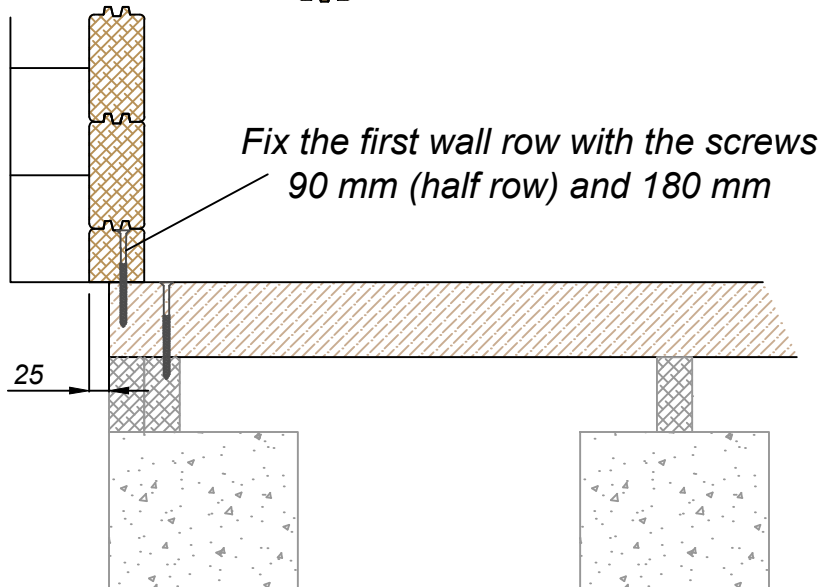

*Fix the first wall row with the screws
90 mm (half row) and 180 mm*

25

THREADED RODS

WHEN INSTALLING THE WALL LOGS,
PLEASE CHECK THAT ALL THE HOLES ARE DRILLED!

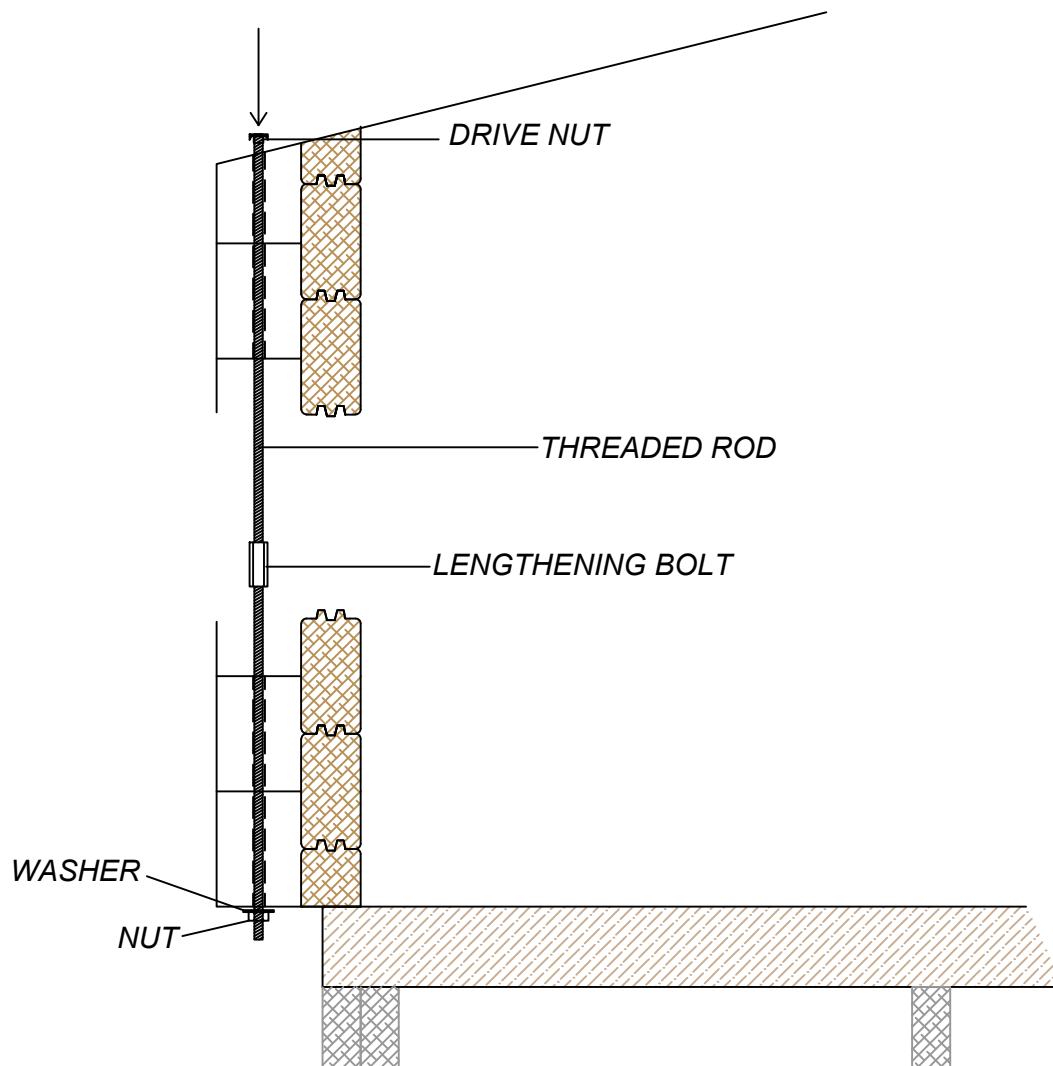

WALL A (OUTSIDE VIEW)

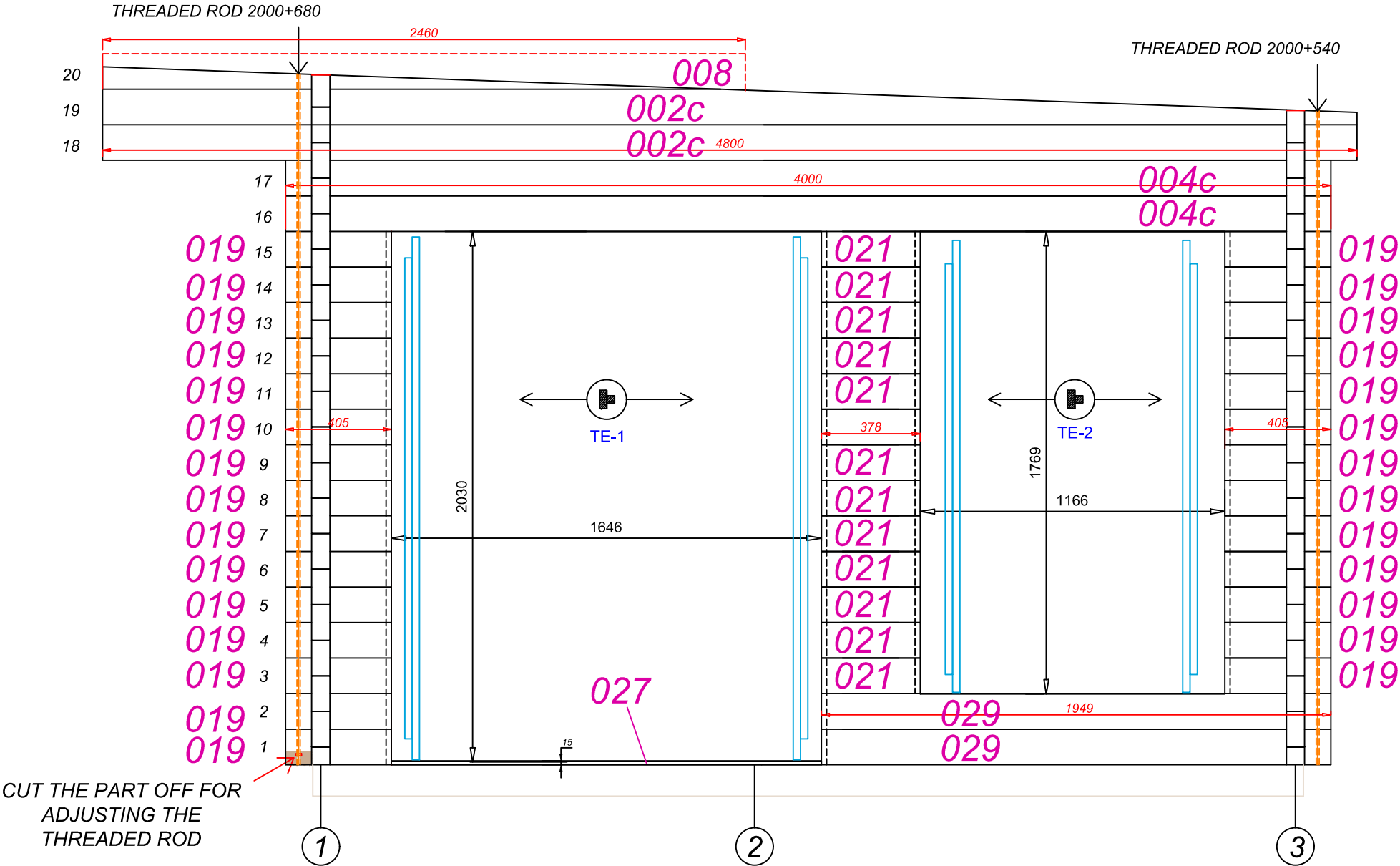

WALL B

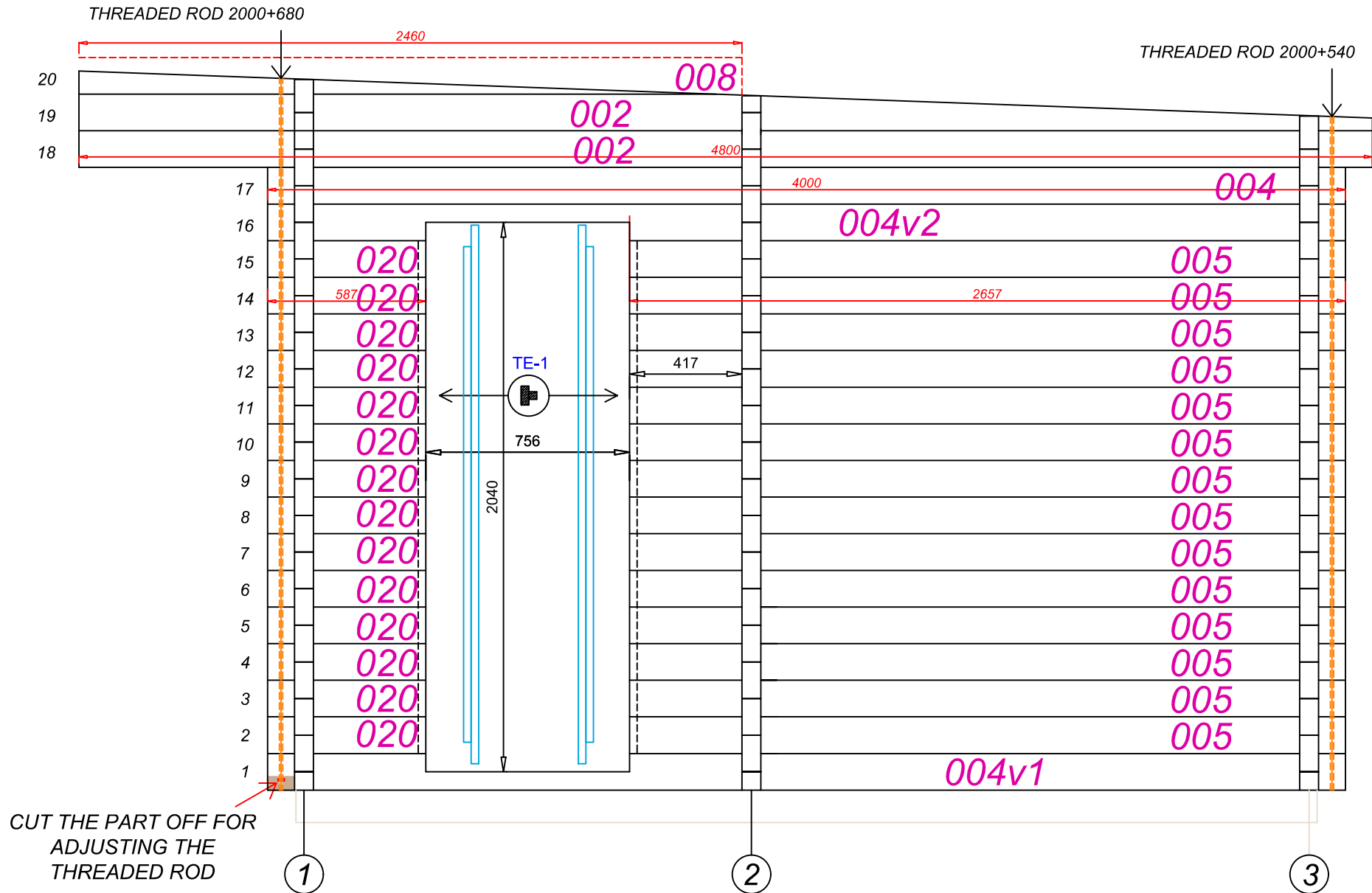

WALL C (OUTSIDE VIEW)

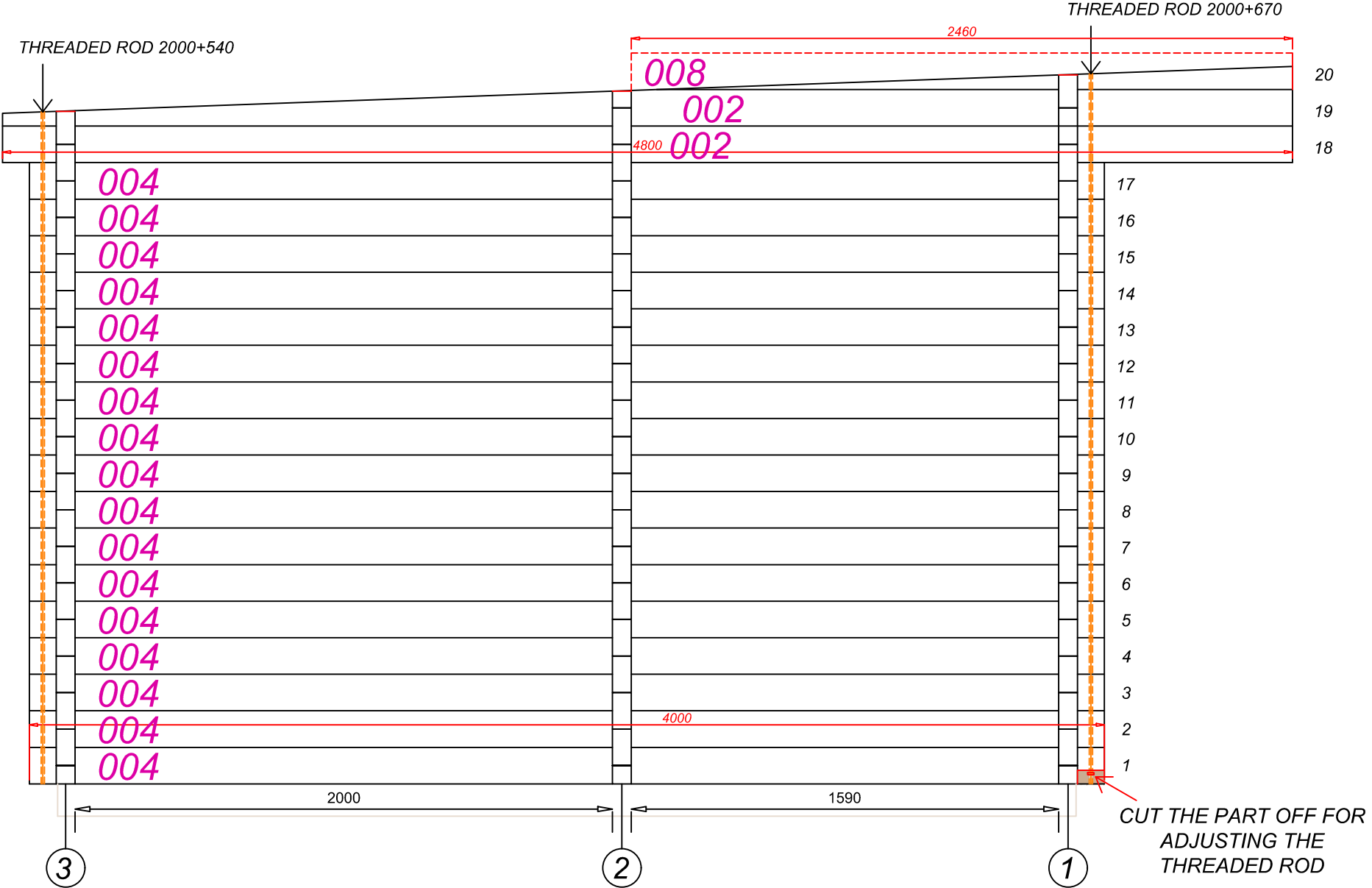

WALL 1

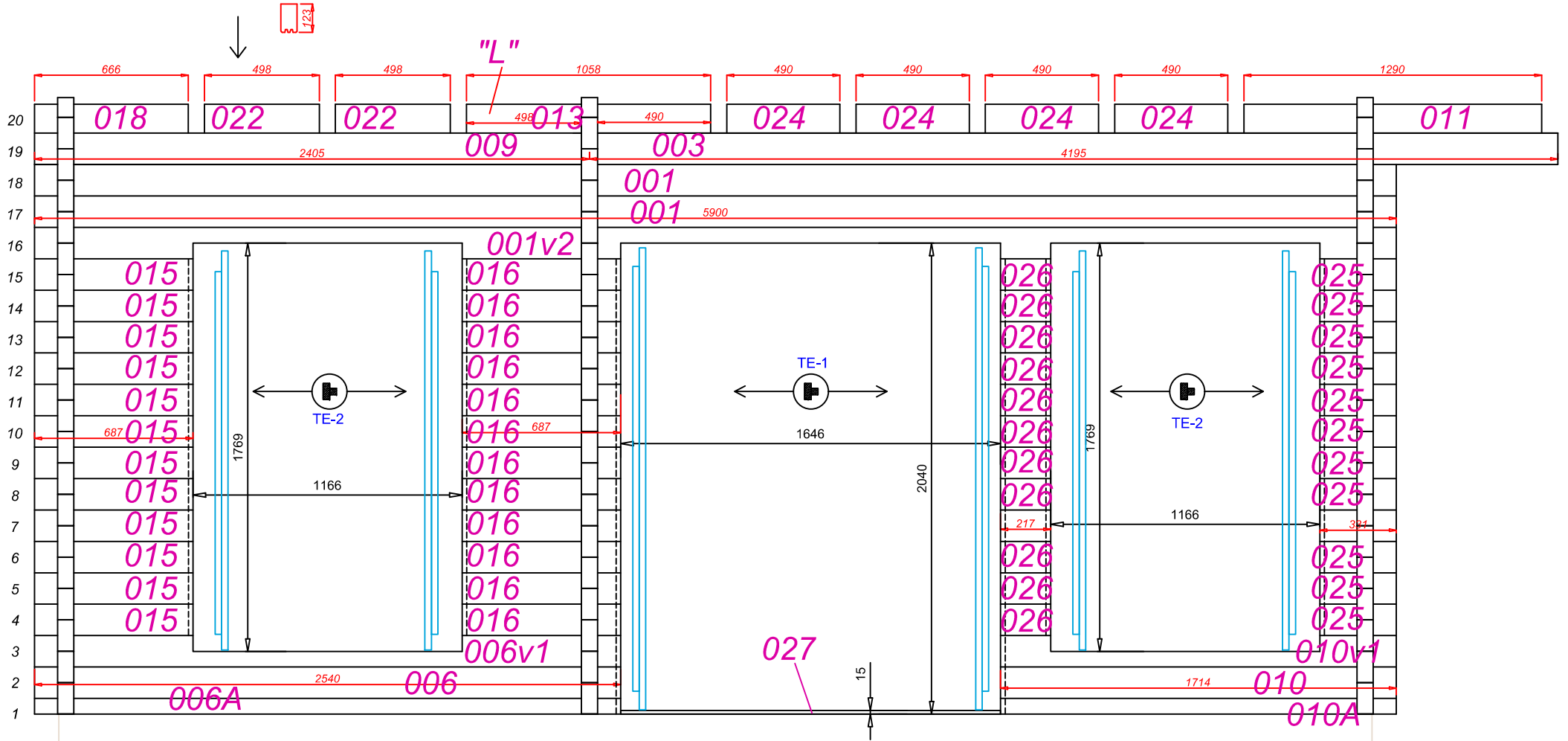

WALL 2

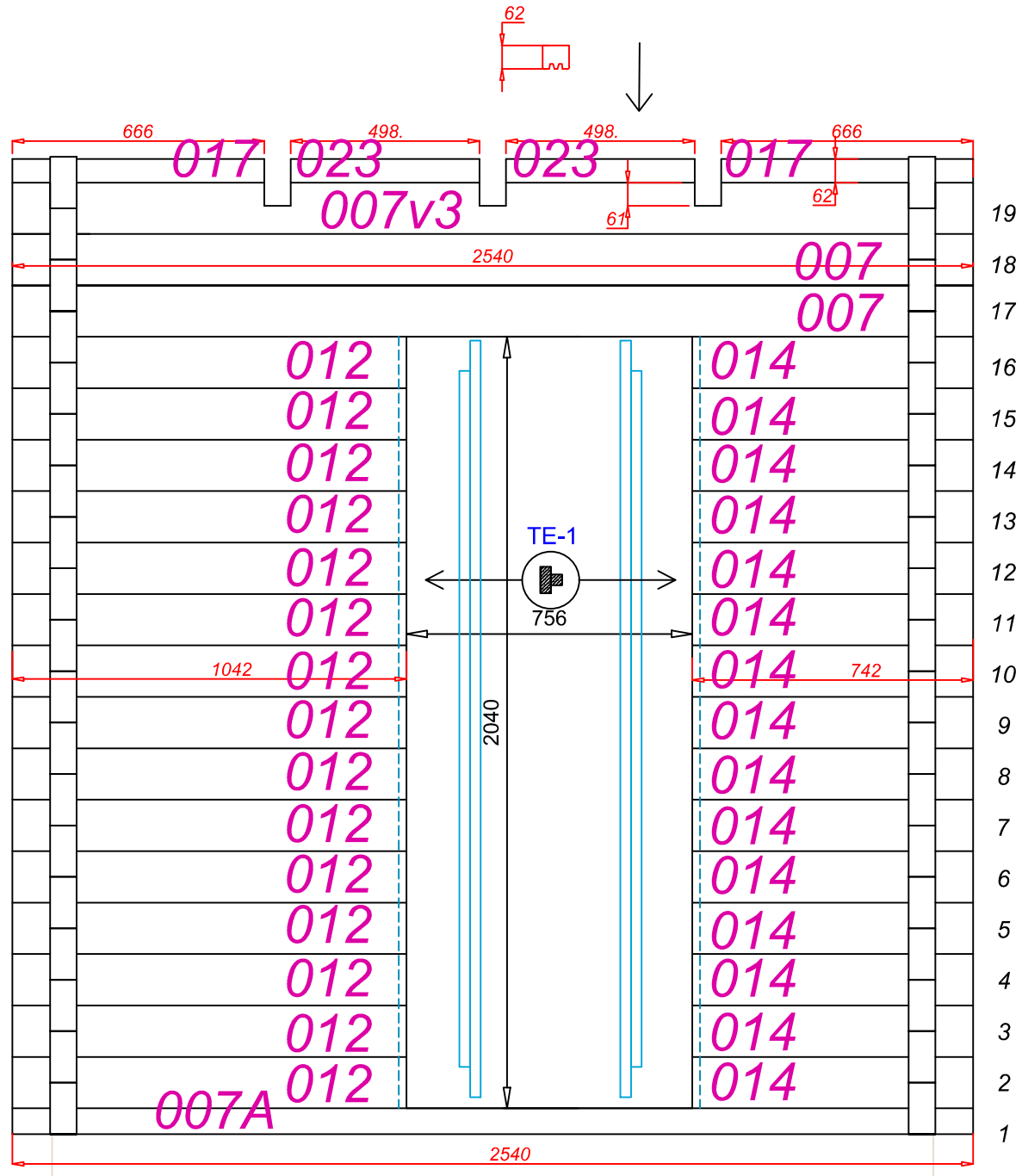

WALL 3 (OUTSIDE VIEW)

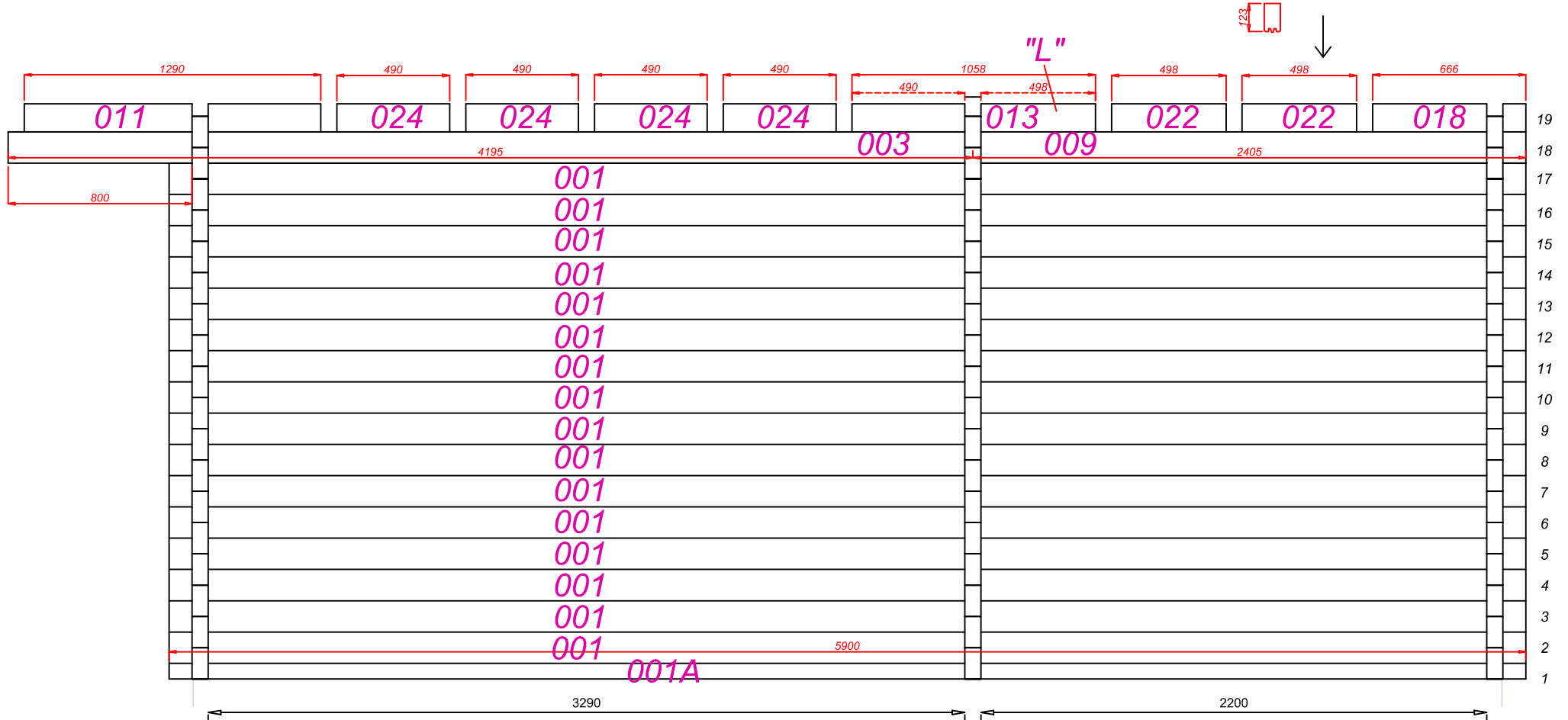

Fix the roof boards with 75 mm nail (2 nails per connection)

ROOF RAFTERS

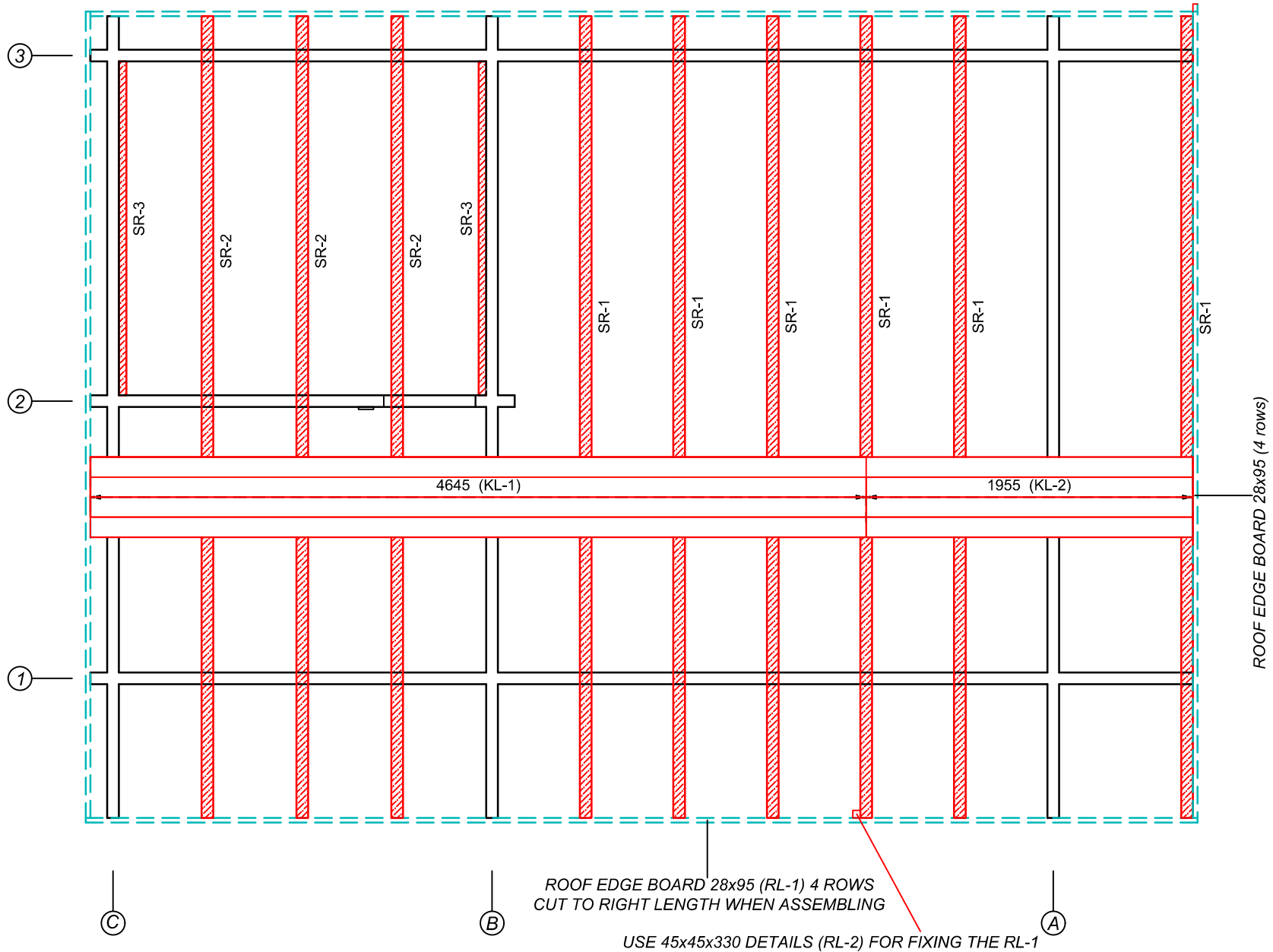

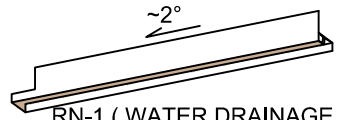

FLOOR AND DECKING BOARD

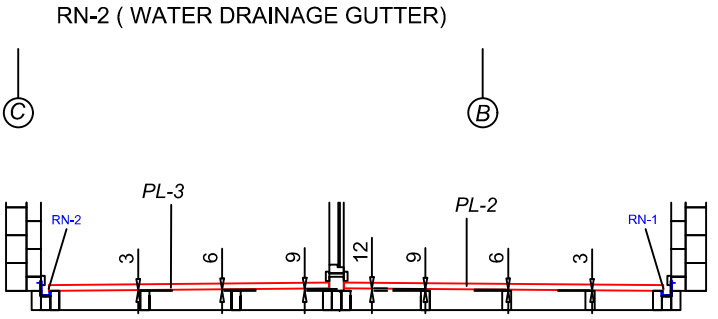
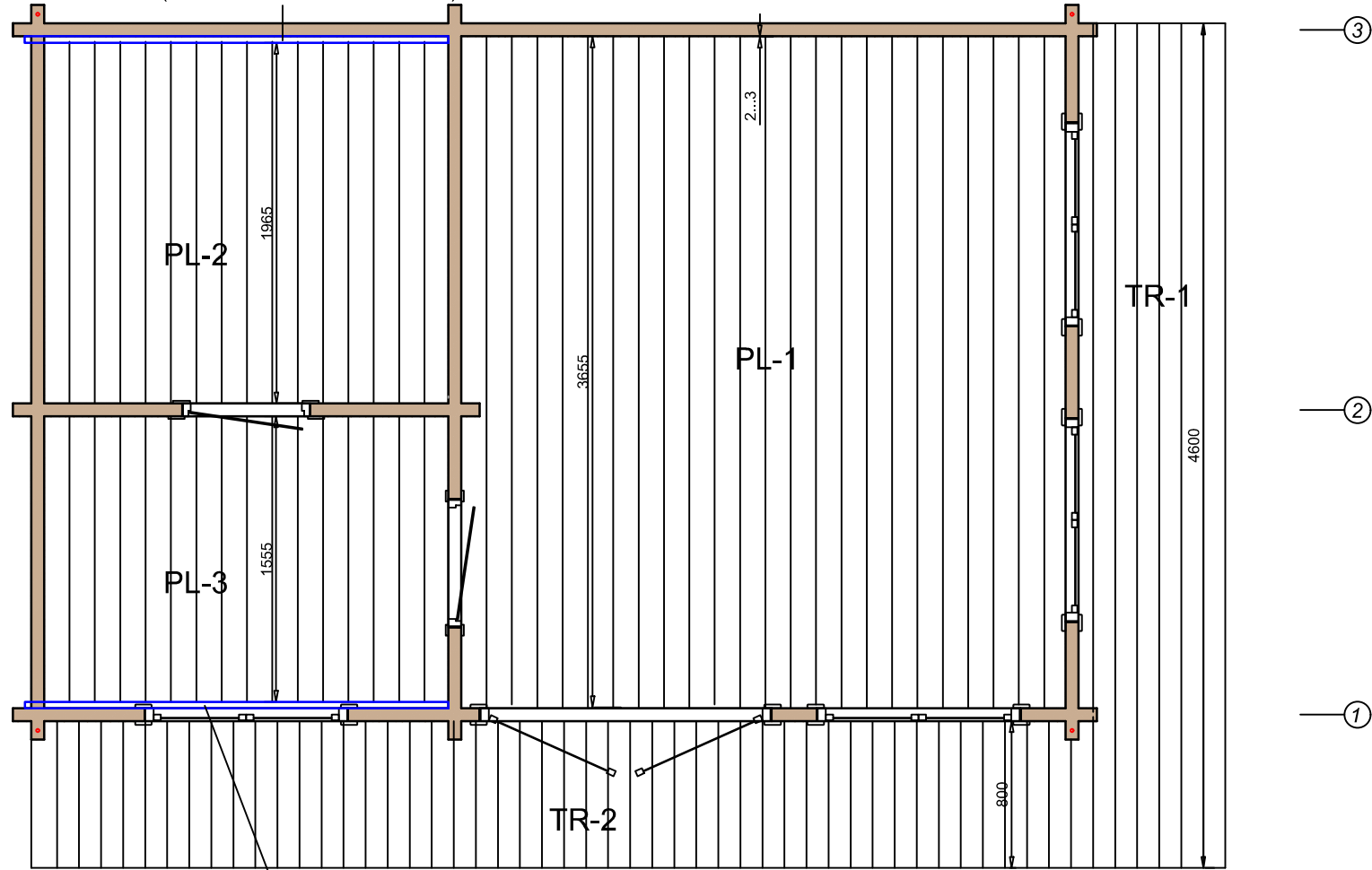

GIVE A SLOPE TOWARDS A WATER GUTTER USING A DISTANCE BOARDS (3, 6, 9, 12 MM)

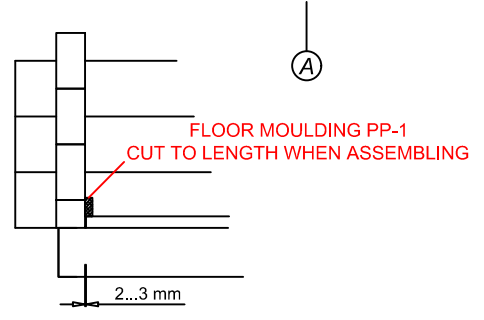

CORNER POST 90x90

NP-1

NP-2

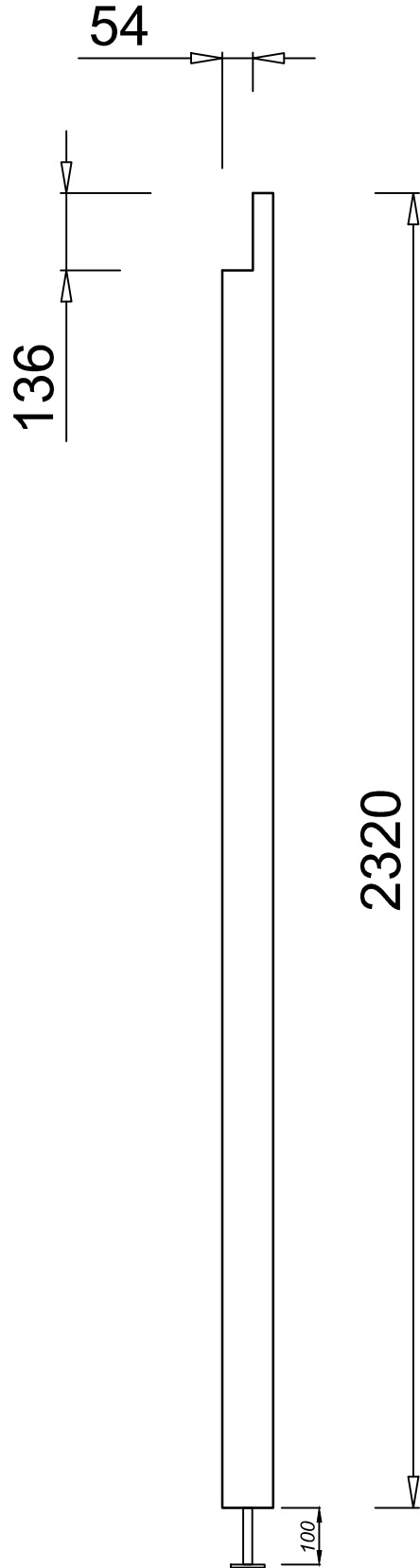
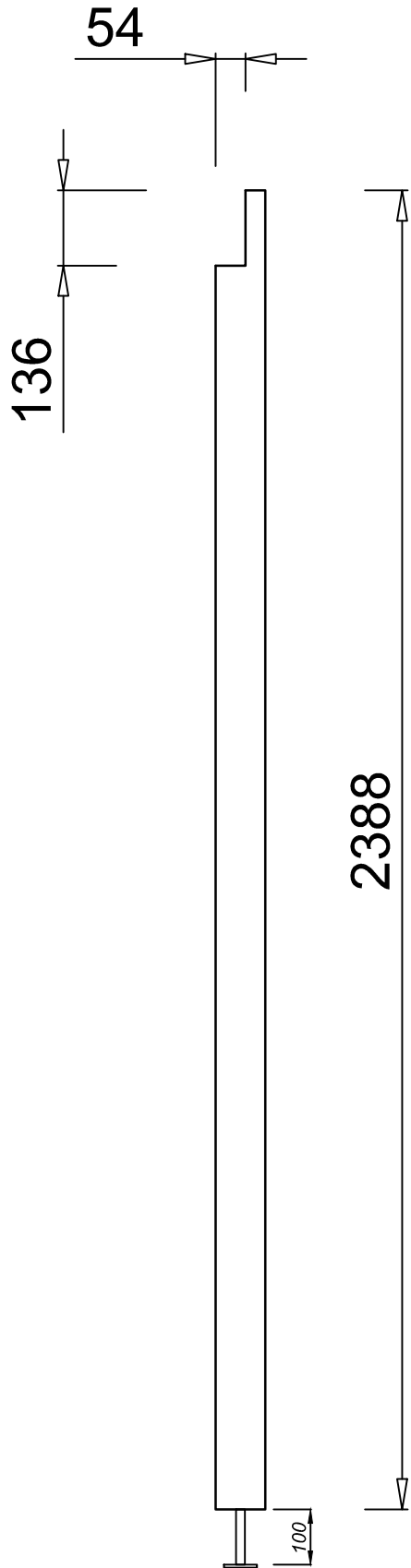

Regulative bolt

GRID WALL VS-1

2 pcs

600

Fix to wall
with L-bracket

Fix to post with
screws

14

45

2140

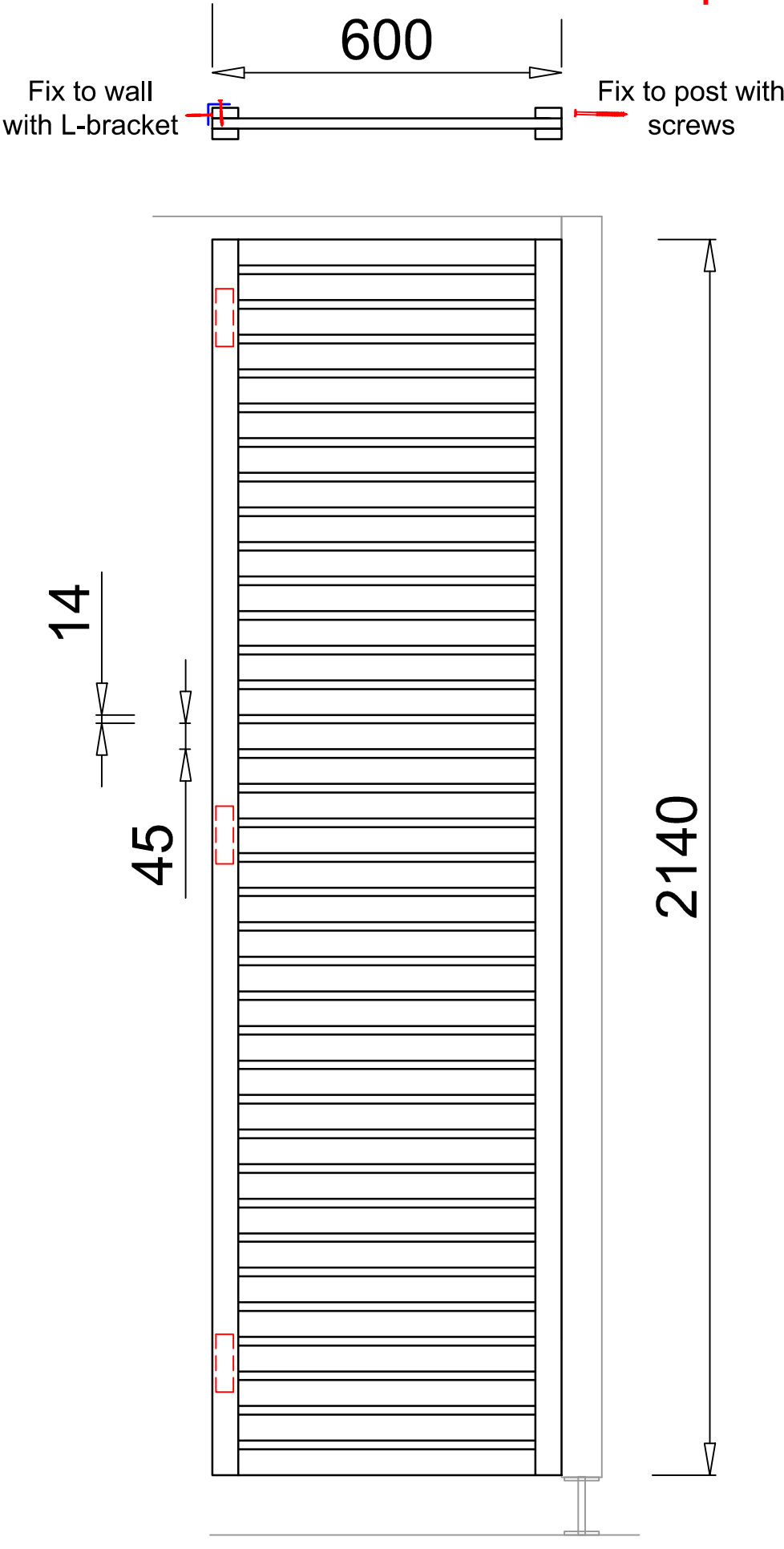

WINDOWS AND DOORS

GLASS DOOR 690x1980 - 2 pcs

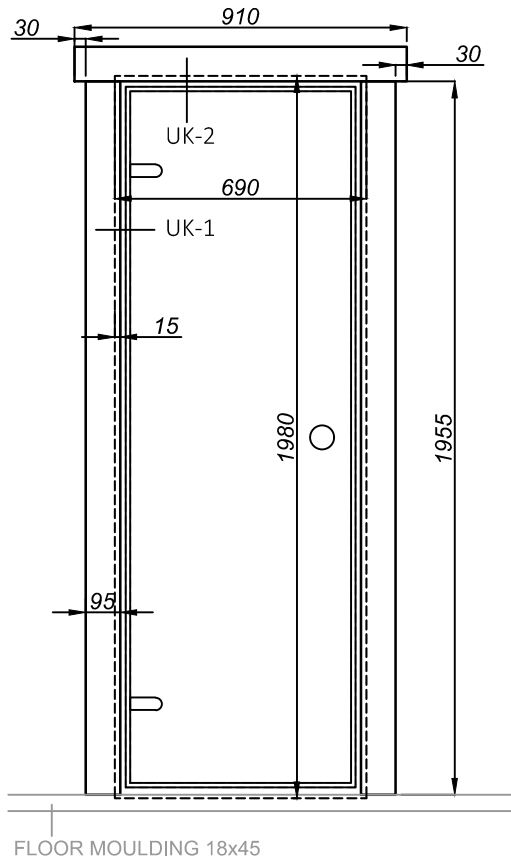

Window 1100x1729 - 3 pcs

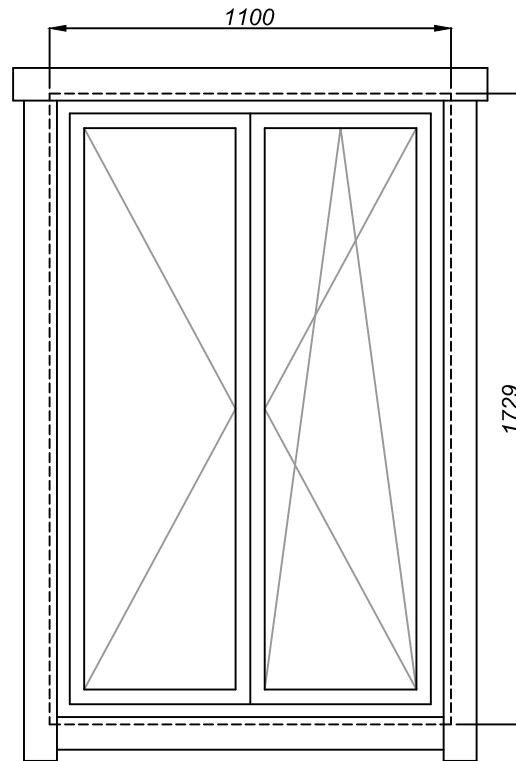

Door 1580x2000 - 2 pcs

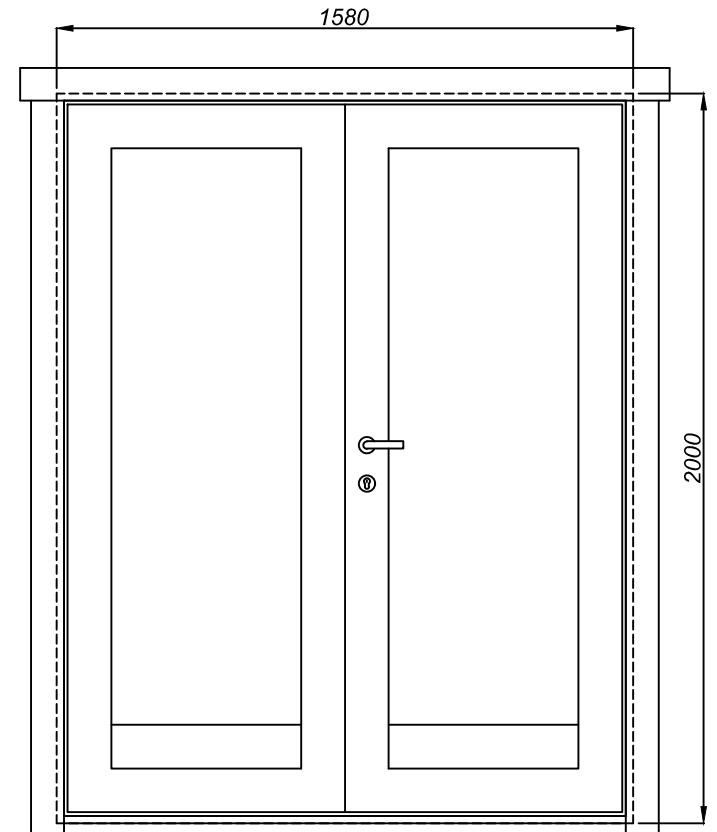

BENCH SET

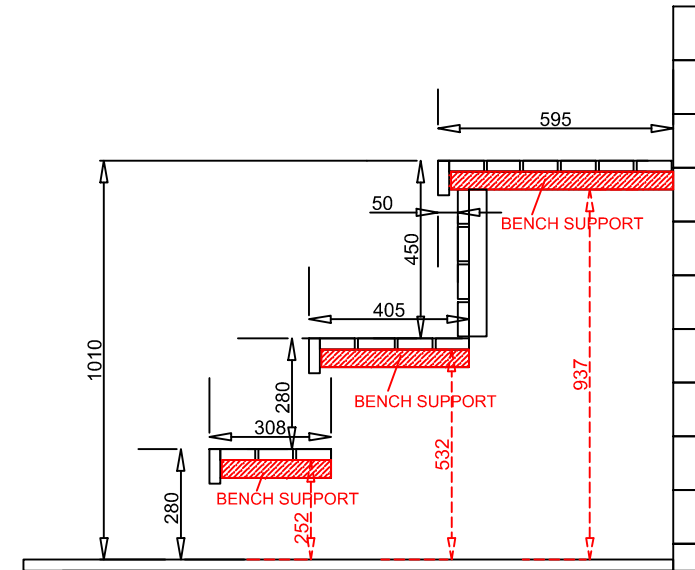
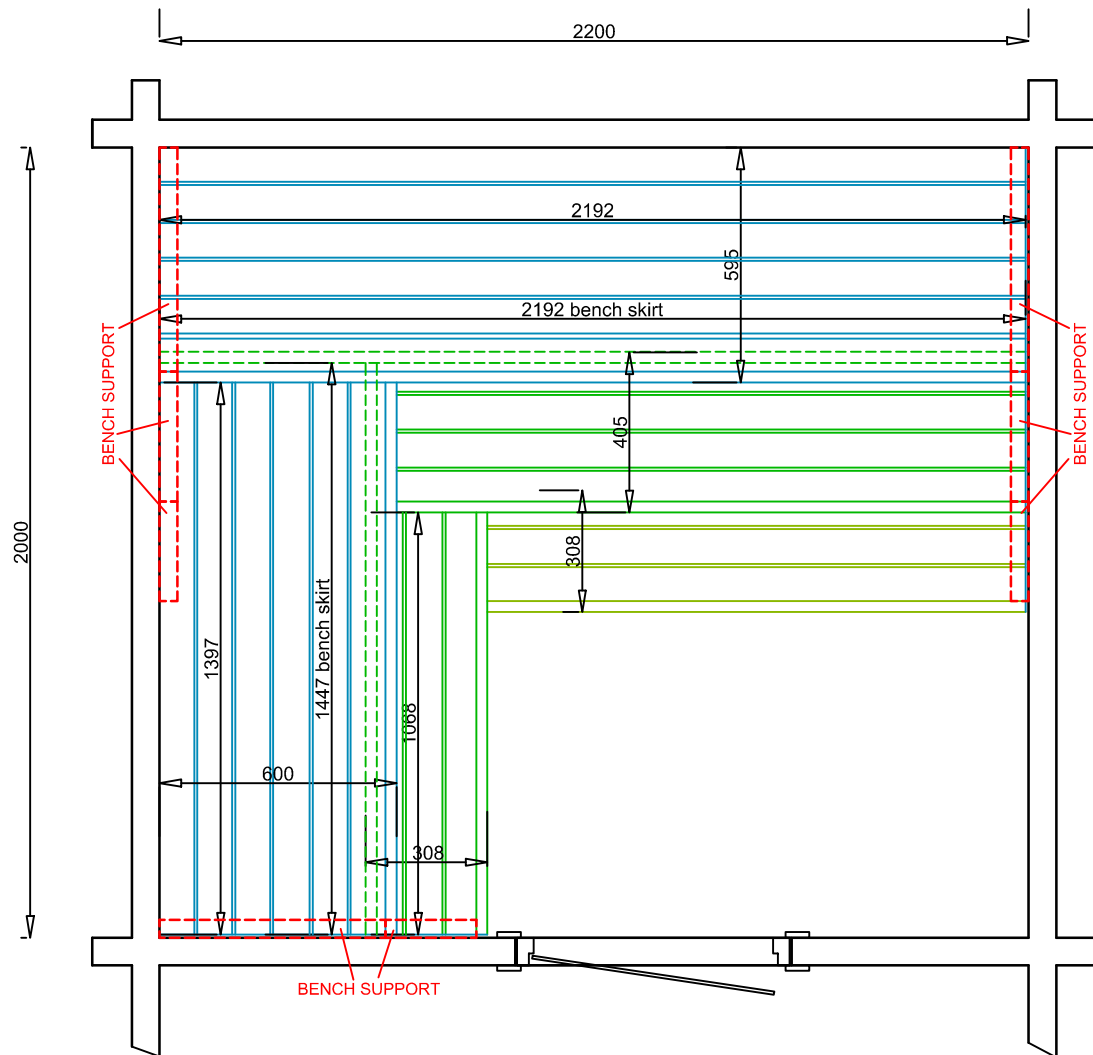

FIX THE HORIZONTAL BENCH SUPPORTS TO THE WALL (CROSS-CUT 45x45, LENGTH SAME AS BENCH FRAME)

USE 80 MM SCREWS

LIFT THE BENCHES TO THE SUPPORTS

FIX THE BENCHES WITH SCREWS THROUGH THE FRAME TO THE SUPPORTS

USE VERTICAL SUPPORT IN THE MIDDLE, IF NECESSARY

HEATER GUARD

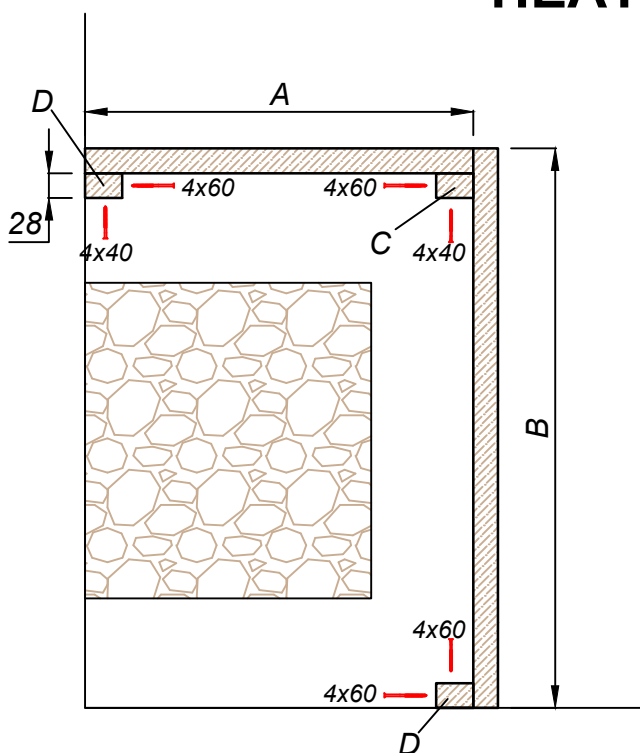

Heater guard DIY package includes:

Detail A: 28x88x640 - 2 pcs

Detail B: 28x88x810 - 2 pcs

Detail C: 28x42x700 - 1 pcs

Detail D: 28x42x350 - 2 pcs

Screw 4x40 - 8 pcs

Screw 4x60 - 16 pcs

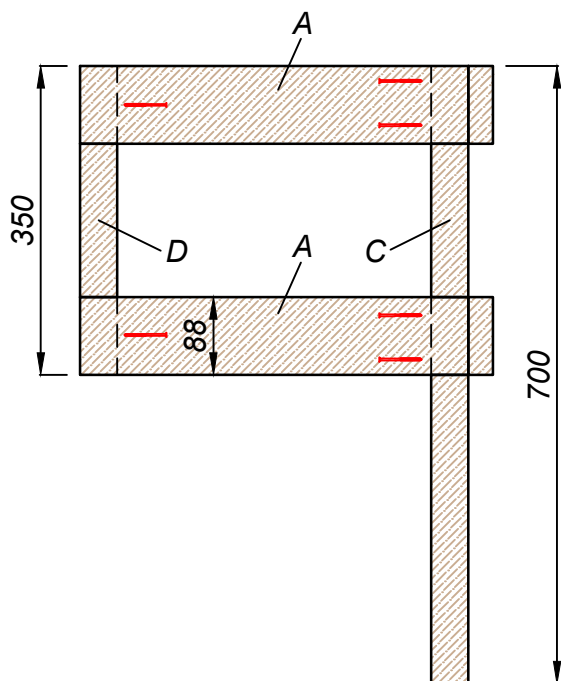

1. Cut the details "A" and "B" to correct measure
2. Fix the details to detail "C" and "D" with the screws
3. Fix the heater guard to the wall
4. **Be sure that safety distances are valid to the heater manual!**

Heater model	A (mm)	B (mm)
ISC 9 kW	440	640
Huum Drop 9 kW	490	810
Huum Hive 9 kW	640	696
Huum Steel 9 kW	520	610