

RAUMA 3 Plus

Installation drawings

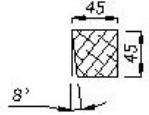

RAUMA 3 Plus

marking			length	pcs				
AR-1	45x95 FLOOR FRAME		2876	1				
AR-2	45x95 FLOOR FRAME	<i>CUTOUT FOR DRAINAGE</i>	2876	1				
AR-3	45x95 FLOOR FRAME	<i>SPECIAL CROSS-SECTION</i>	1980	1				
AR-4	45x 70 FLOOR FRAME		1980	1				
AR-5	45x95 FLOOR FRAME		1980	9				
PL-1	28x120 FLOOR BOARD		1960	18+2				
TL-1	28x120 DECKING BOARD		800	18				
TL-2	28x120 DECKING BOARD		2070	1				
SR-1	45x145 ROOF RAFTER		3406	2				
RL-1	18x95 ROOF EDGE BOARD		3406	2				
RL-2	18x95 ROOF EDGE BOARD	<i>CUT TO LENGTH !</i>	~2800	2				
RT-1	45x45 ROOF EDGE SUPPORT FRAME		3406	2				
TR-1	45x45 FRAME DETAIL FOR CEILING PANEL		2000	2				
SL-2	15x55 DISTANCE BOARD FOR CEILING		2000	5				
PP-1	15x55 MOULDINGS FOR FLOOR/CEILING		2000	10				
SL-1	14x121 CEILING PANEL		2015	20				
KL-1	29x120 ROOF BOARD		2668	32				

RAUMA 3 Plus

marking			length	pcs				
	BENCH MODULE 600x1992			1				
	BENCH MODULE 300x1992			1				
	BENCH MODULE 500x1396			1				
	BENCH MODULE 200x1160			1				
	BENCH SKIRT 376x1992			1				
	BENCH SKIRT 376x1441			1				
	BENCH SUPPORT SET 45x45			1				
	OUTDOOR BENCH 563x750			1				
	HEATER GUARD DIY SET			1				
VS-1	GRID WALL 650x1756			1				
NP-1	70x70 CORNER POST		1912	1				

RAUMA 3 Plus

marking			length	pcs				
RN-1	WATER DRAINAGE PROFILE (OPENING RIGHT)			1				
extra	WATER DRAINAGE PROFILE (OPENING LEFT) TO USE AS "MIRROR"			1				
	3 MM DISTANCE DETAIL FOR FLOOR SLOPE		1995	1				
	6 MM DISTANCE DETAIL FOR FLOOR SLOPE		1995	1				
	9 MM DISTANCE DETAIL FOR FLOOR SLOPE		1995	1				
	12 MM DISTANCE DETAIL FOR FLOOR SLOPE		1995	1				

	SPU INSULATION WITH FOIL 30x600x1200			6				
--	--------------------------------------	--	--	---	--	--	--	--

--	--	--	--	--	--	--	--	--

RAUMA 3 Plus

marking		length	pcs				
	SCREW 3,0x40 A2 STAINLESS FOR MOULDINGS		100				
	SCREW 4,8x90 A2 STAINLESS FOR WALL CONNECTIONS (CORNERS)		300				
	SCREW 4,8x55 A2 STAINLESS FOR DECKING BOARDS		200				
	SCREW 3,5x50 AW20 FOR FLOOR BOARDS		100				
	SCREW 4,5x70 FOR ROOF EDGE AND BENCH SUPPORTS		100				
	SCREW 5,0x90 FOR FLOOR FRAME AND WALL CONNECTIONS		100				
	SCREW 5,0x120 FOR WALL CONNECTIONS		25				
	SCREW 6,0x180 FOR ROOF RAFTERS AND WALL CONNECTIONS		25				
	NAIL 75 MM FOR ROOF BOARD		~300				
	NAIL 40 MM FOR CEILING BOARD		~300				
	SCREW 4,8x40 FOR L-IRON		10				
	L-IRON 30x30x130 FOR GRID WALL		3				
	WASHER M5 FOR L-IRON 30x30x130 (GRID WALL)		3				
	ADJUSTABLE LEVELLING BOLT 60x60 FOR CORNER POST		1				
	VENTILATION LOUVER WOOD D100		2				
	VENTILATION GRID METAL D100		2				
	FOIL TAPE		1				

WALL LOGS 40x146

	extra	1 pcs	
	01	2 pcs	
	02	2 pcs	
	03	42 pcs	
	03A	2 pcs	
	03C	2 pcs	
	04C	2 pcs	
	05	28 pcs	
	006C	2 pcs	
	07	8 pcs	

RAUMA 3 PLUS

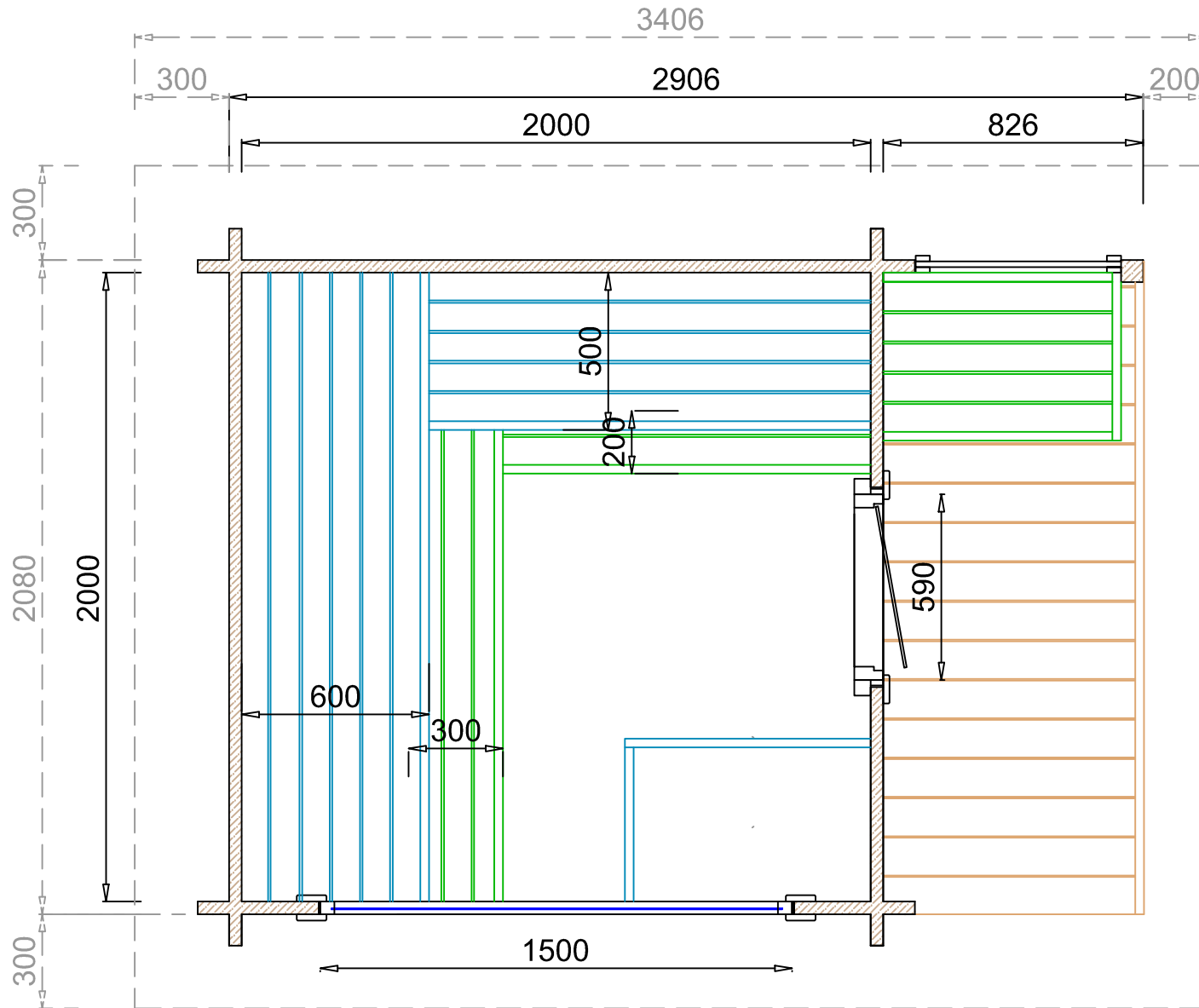

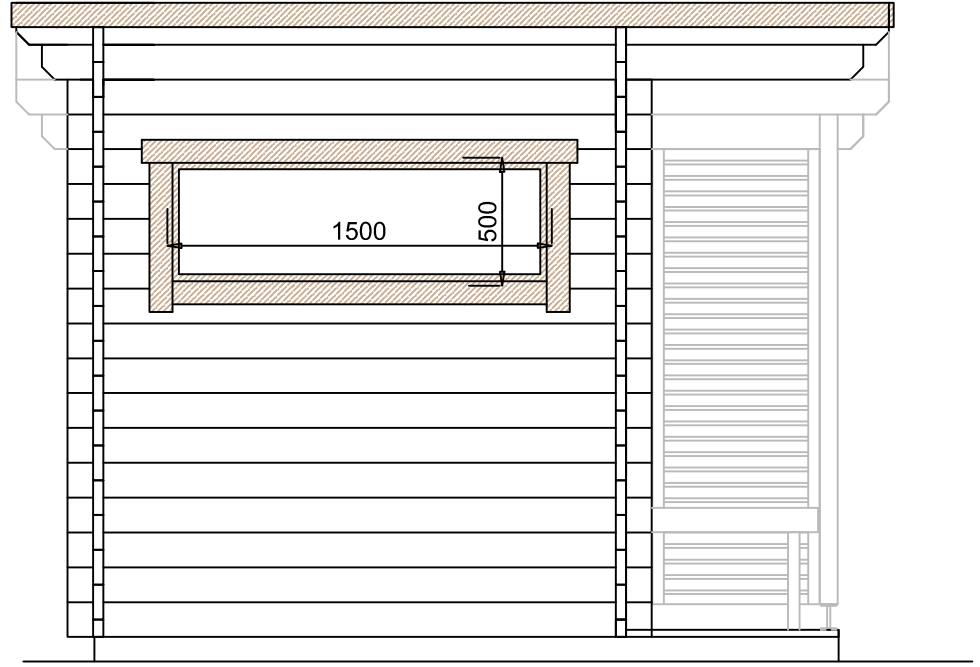
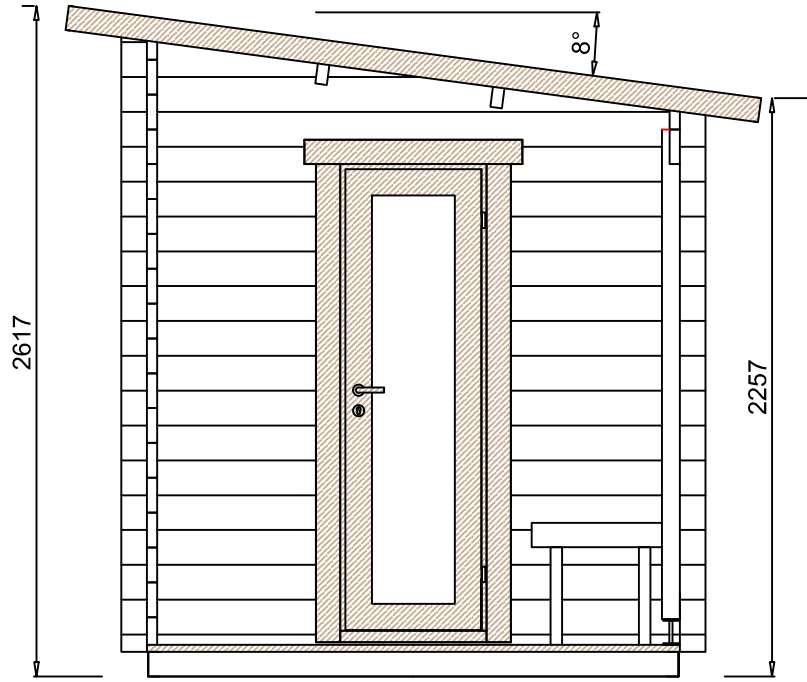

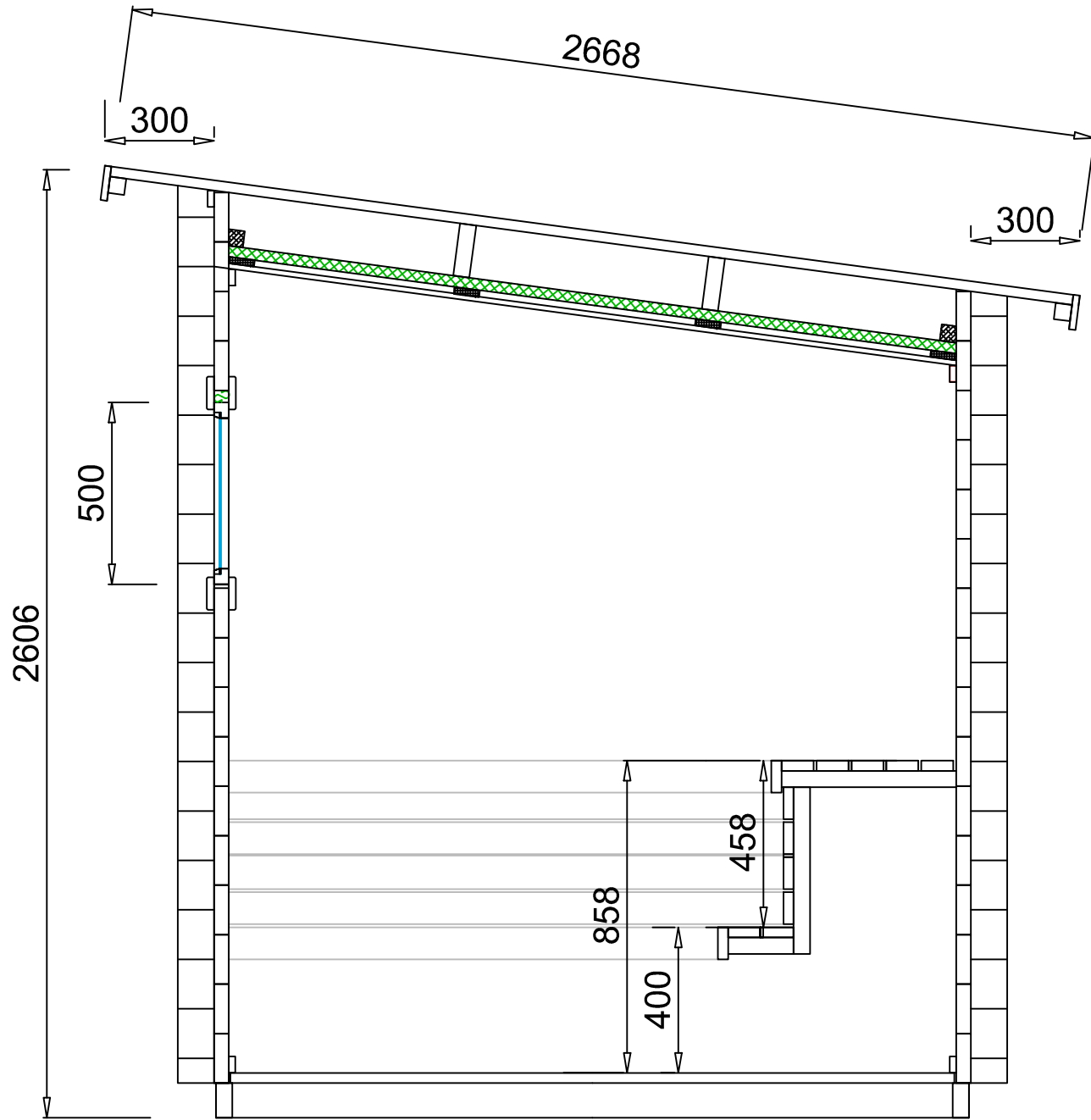

FLOOR FRAME 45x95

ADD DISTANCE BOARDS UNDER THE FLOOR BOARDS
FOR FLOOR SLOPE

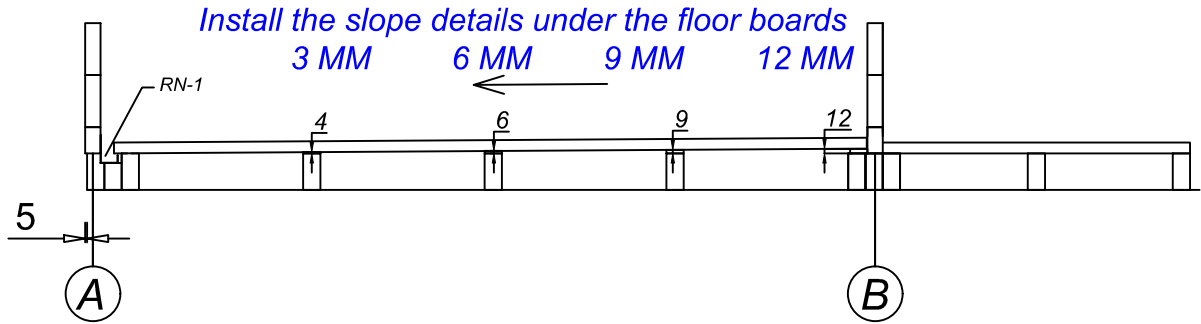

AR-3 CROSS-SECTION

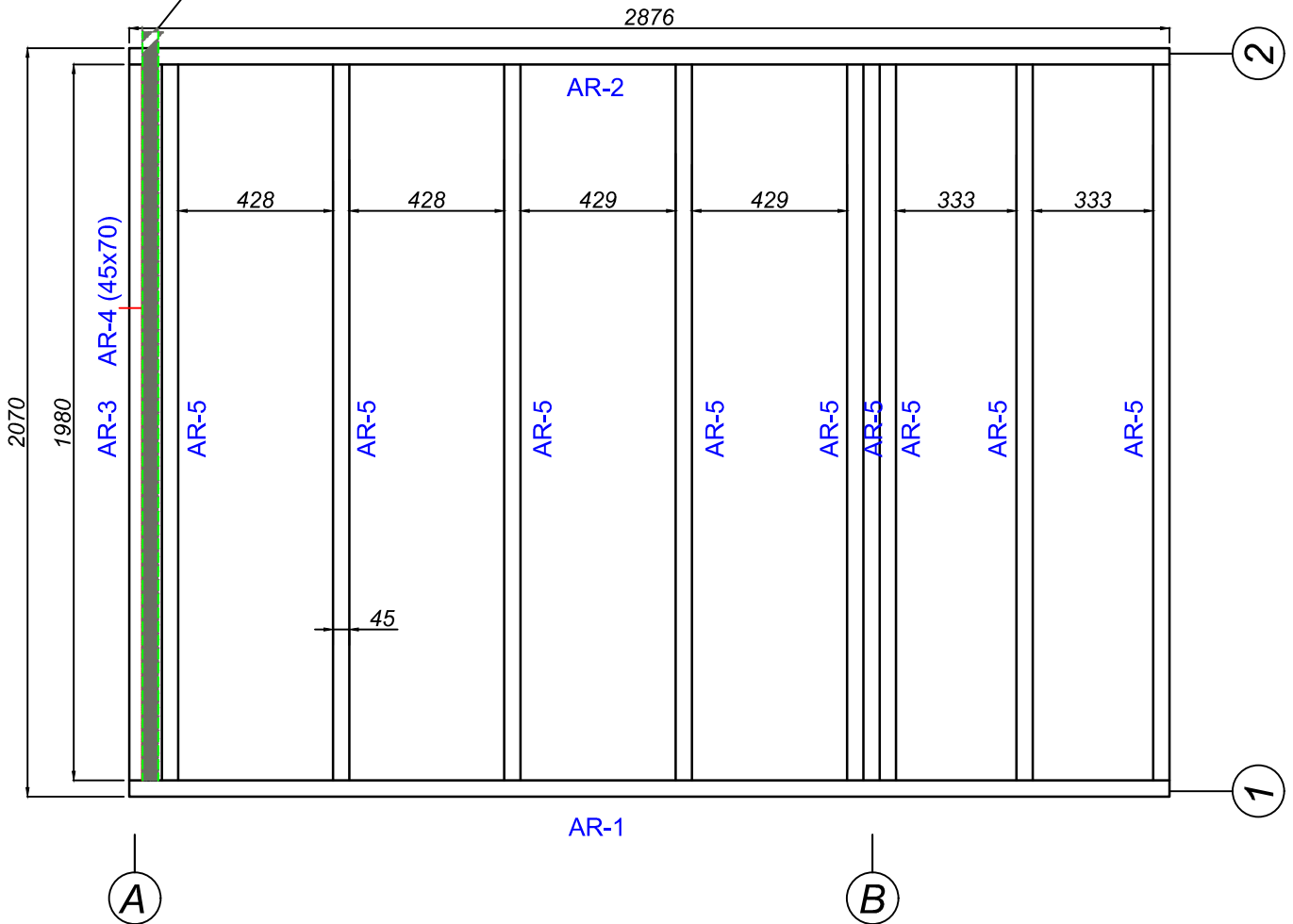
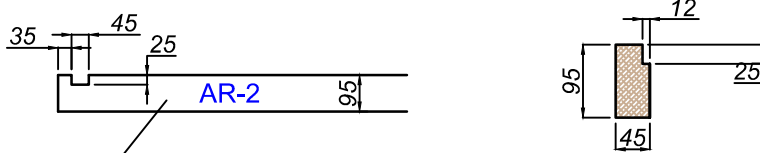

FLOOR FRAME

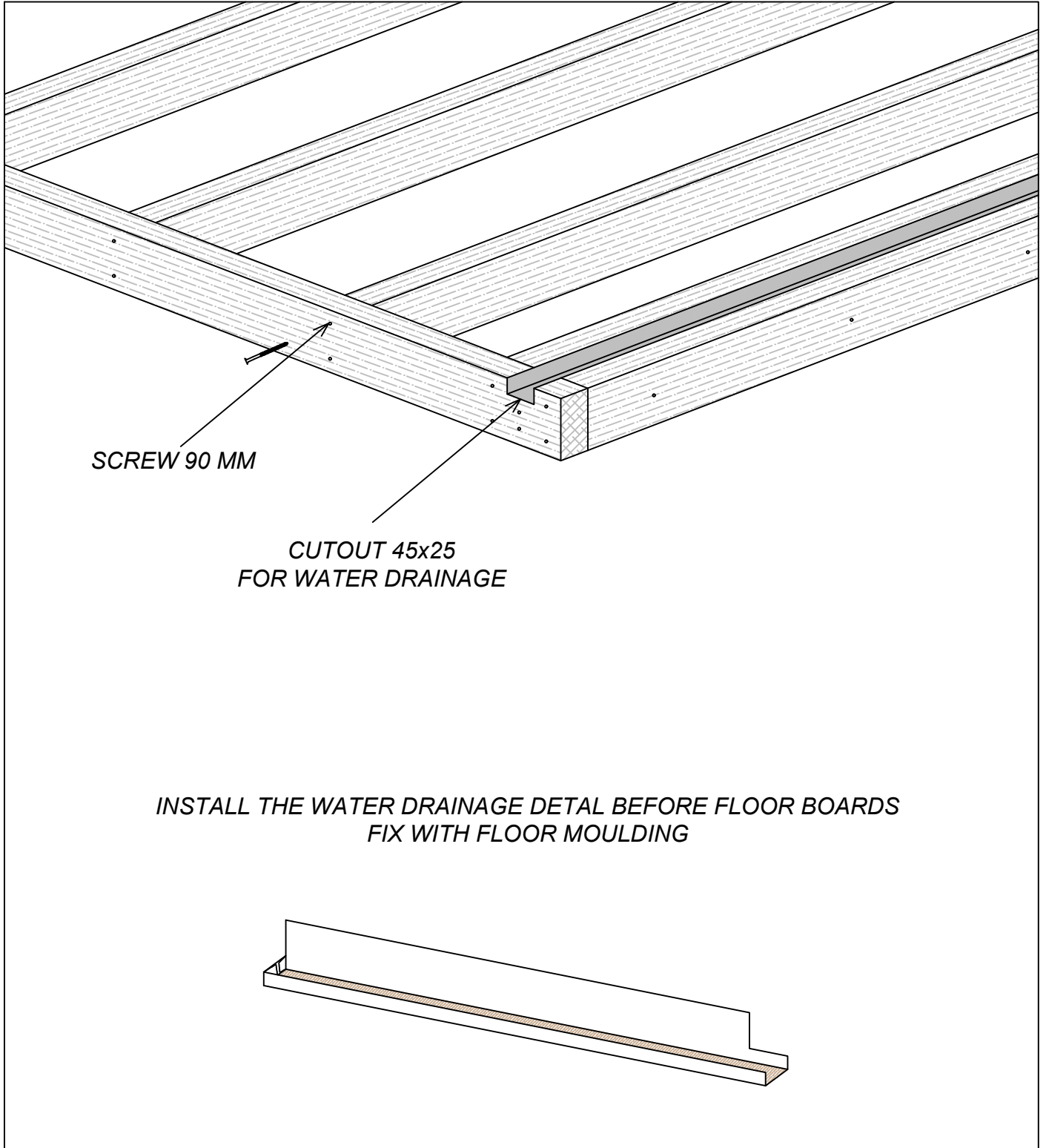

FLOOR BOARDS AND DECKING BOARDS

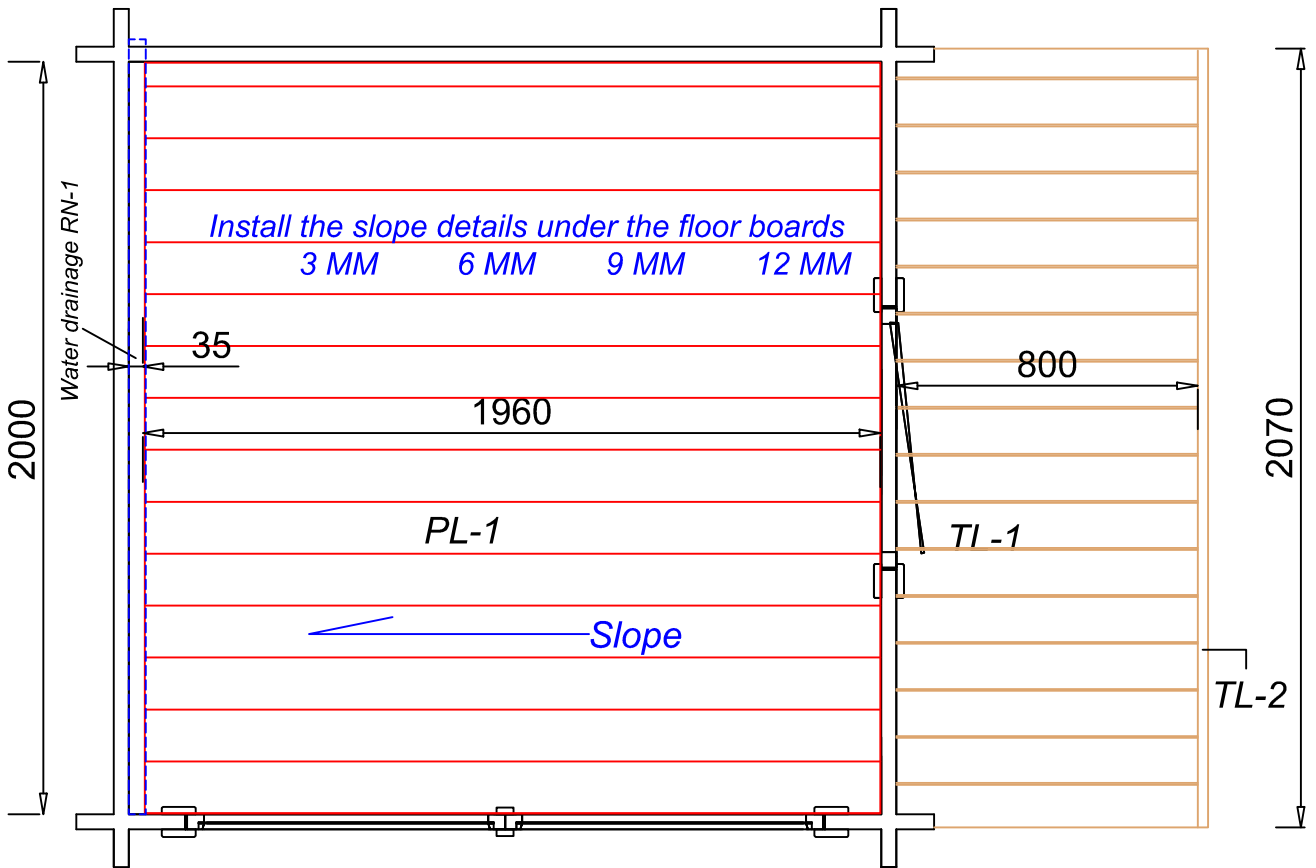

BEFORE THE FLOOR BOARD, INSTALL FLOOR SLOPE DETAILS

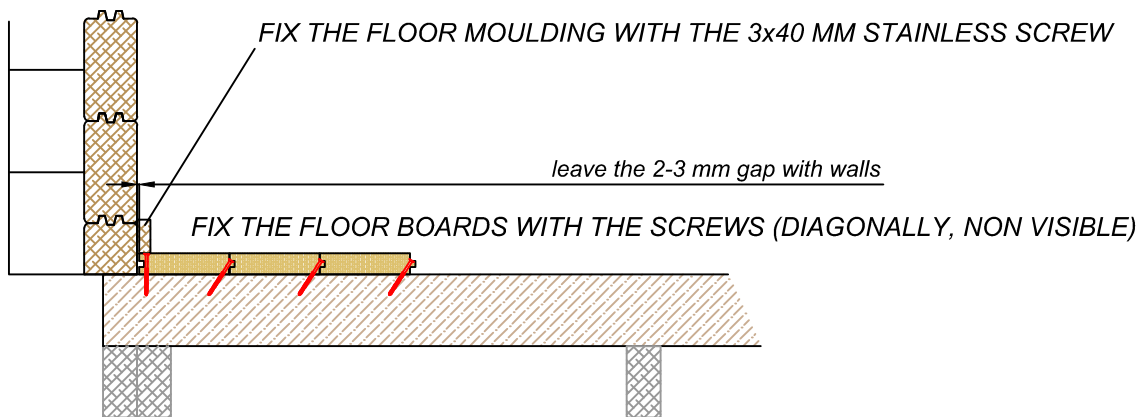

FIRST ROW

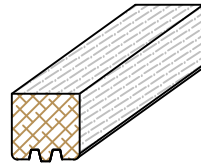
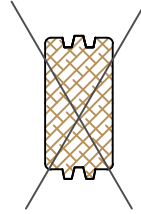

Use rubber hammer and hammer block

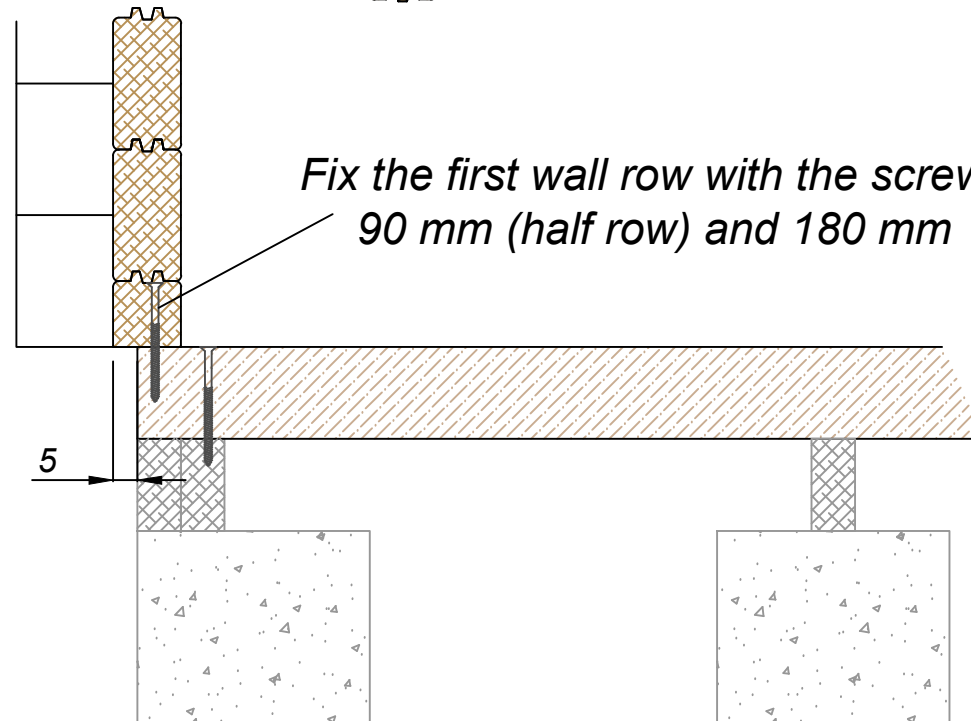

*Fix the first wall row with the screws
90 mm (half row) and 180 mm*

5

**IN EACH CONNECTION USE 90 MM STAINLESS SCREWS
(TO PROTECT THE BUILDING FOR WIND)**



WALL 1

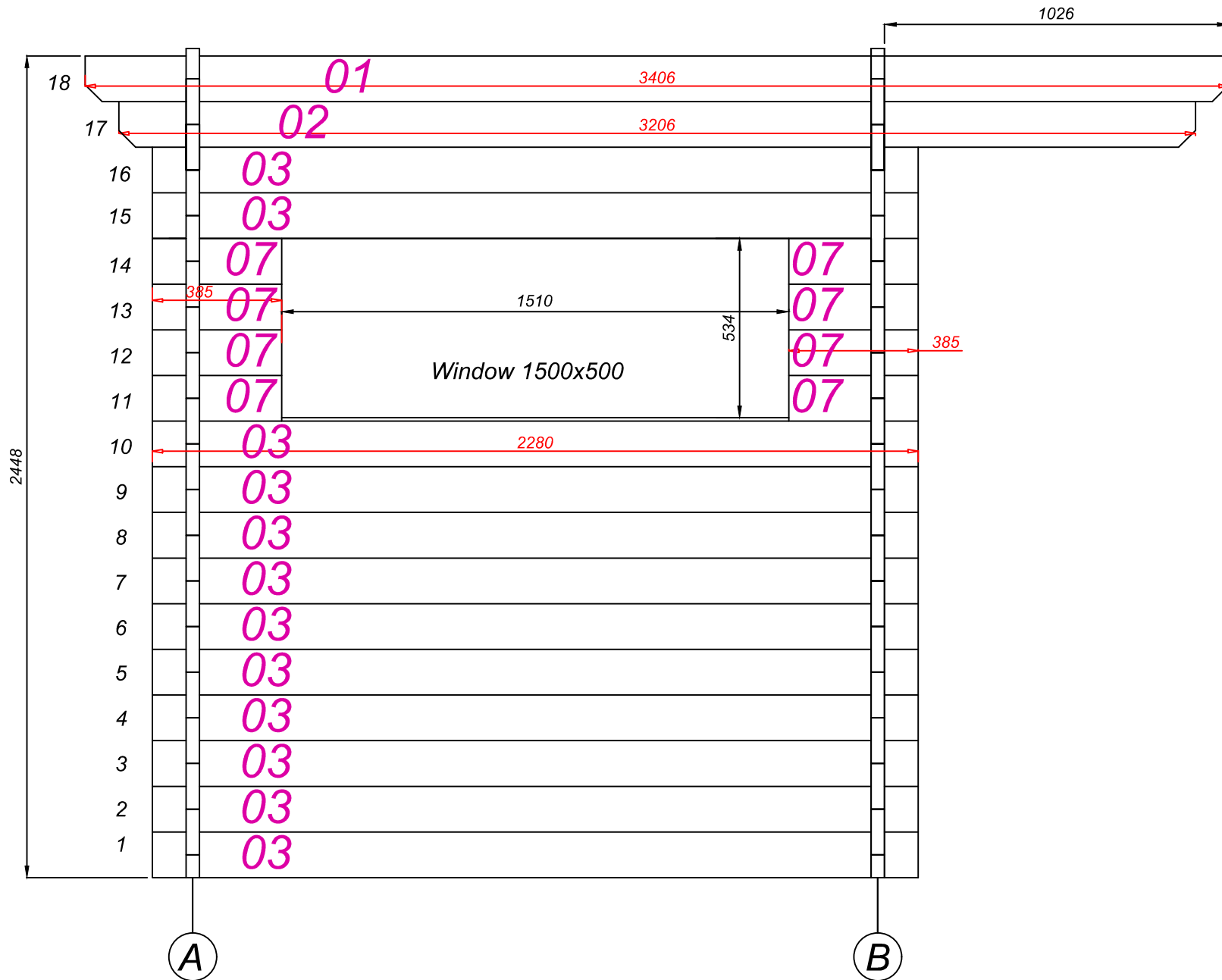

WALL 2

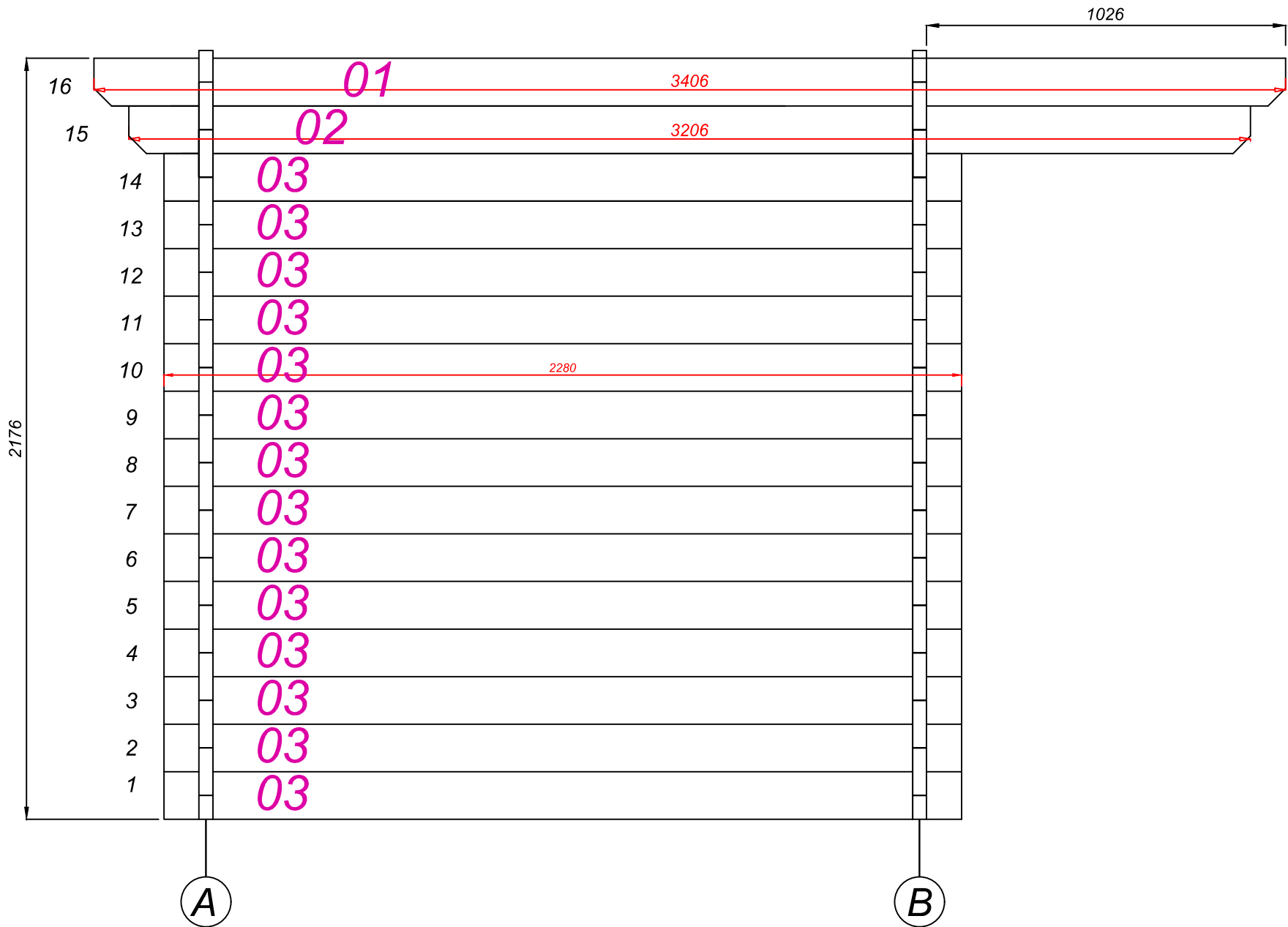

WALL A

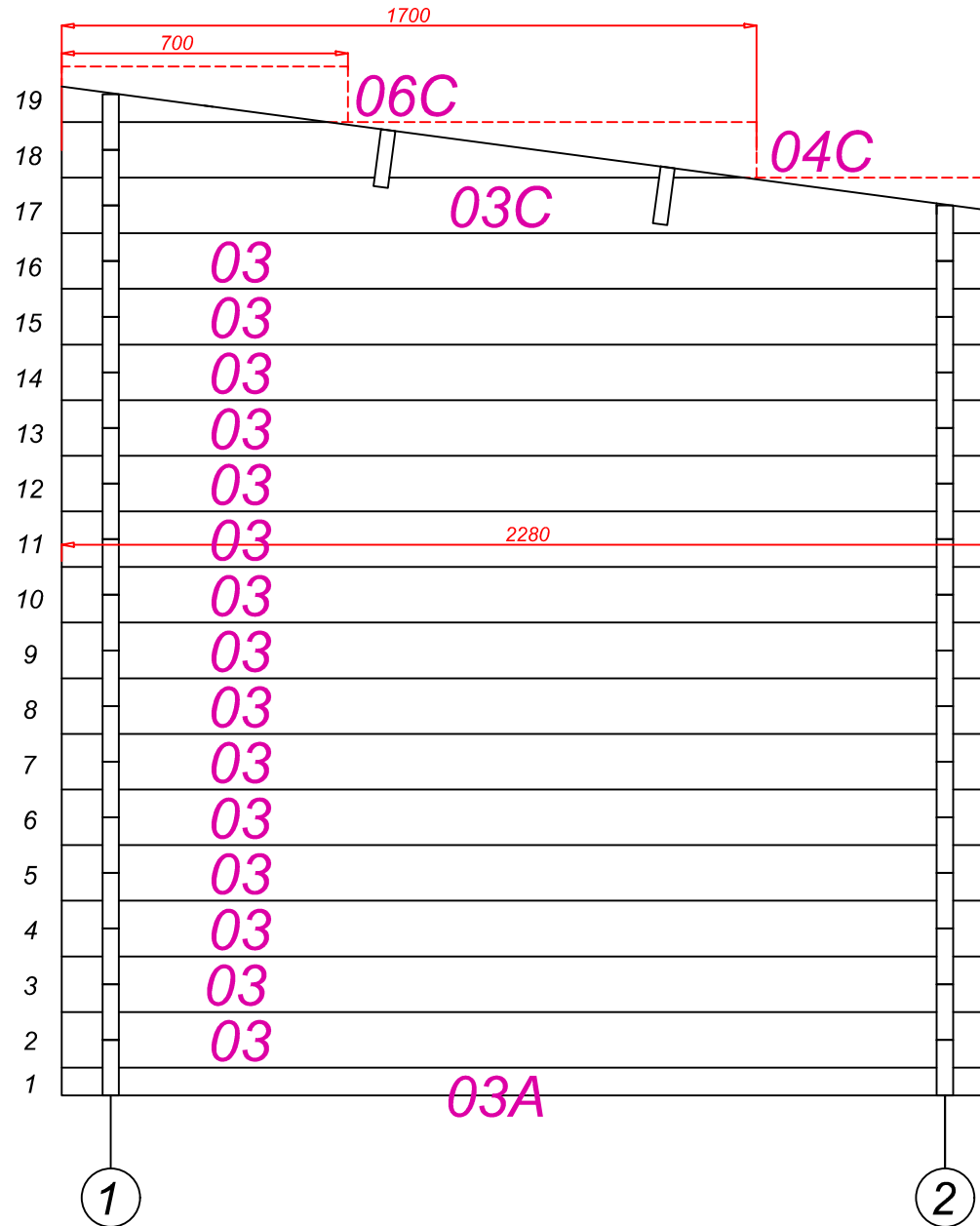

WALL B

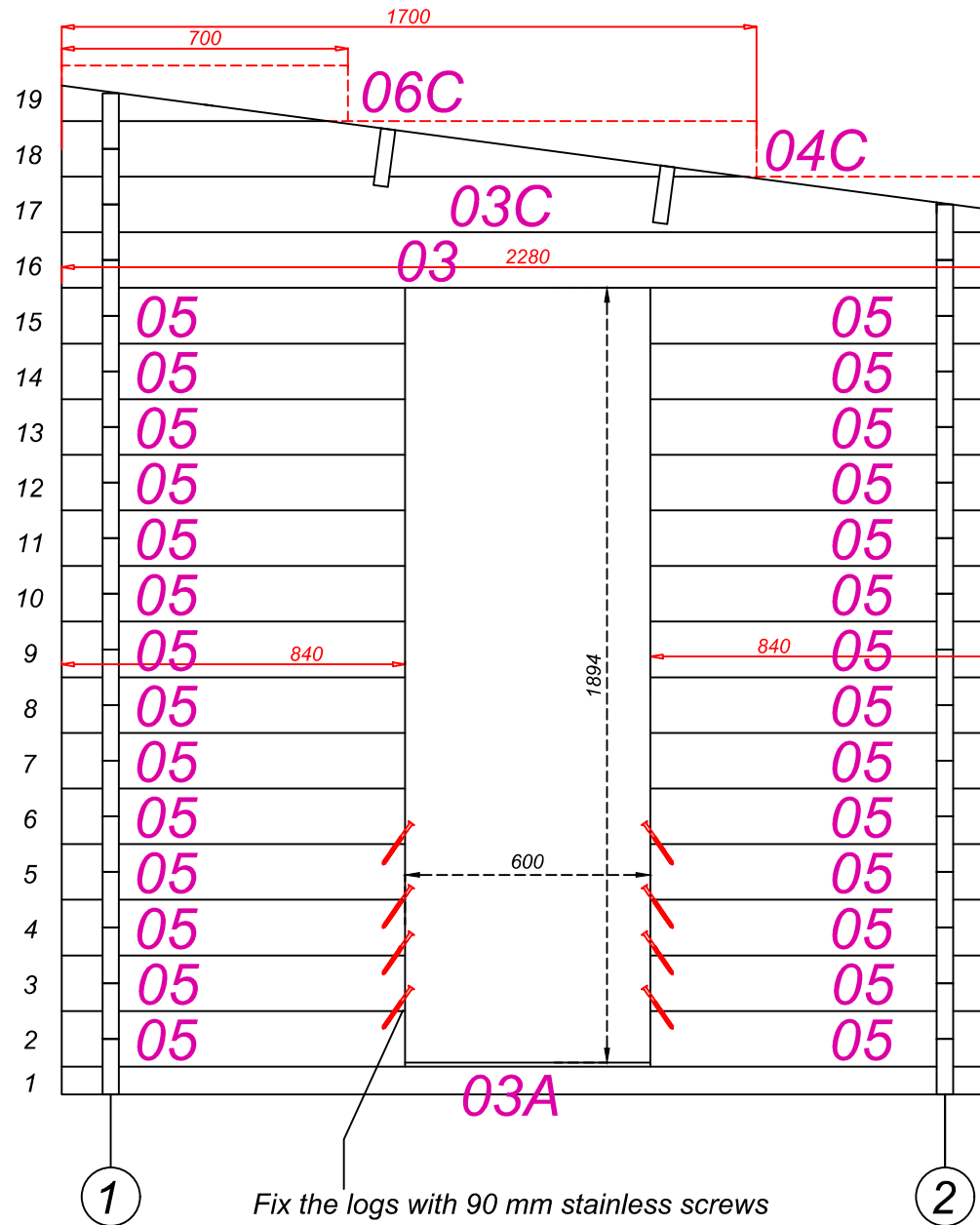

ROOF RAFTER SR-1 (2 pcs)

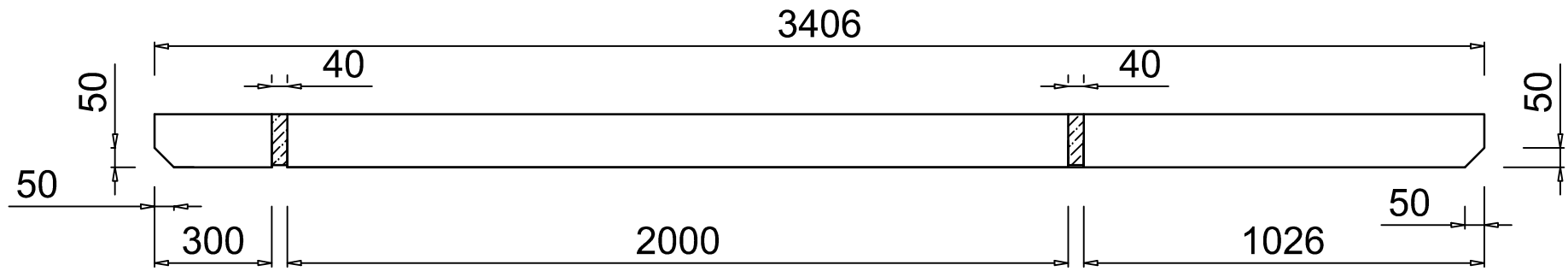

CEILING INSULATION

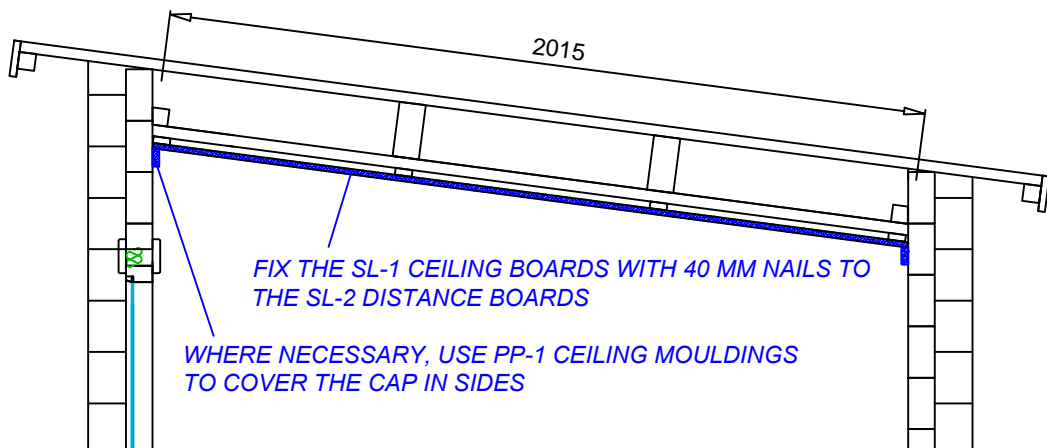
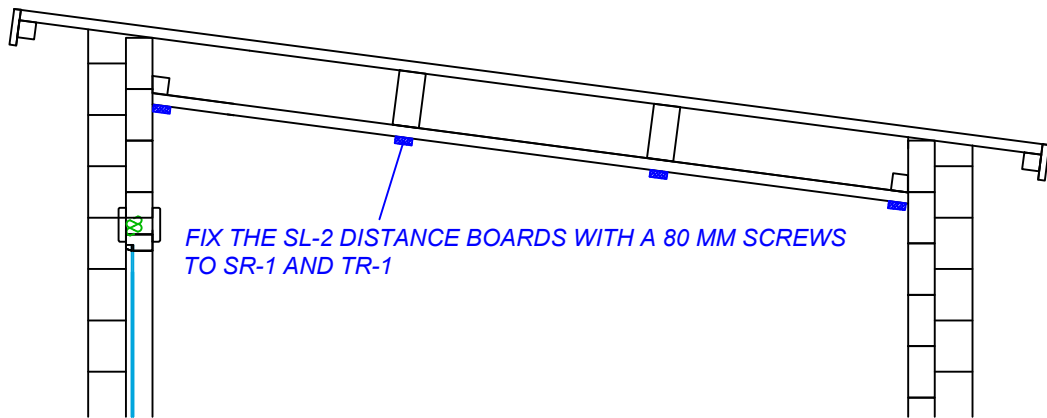
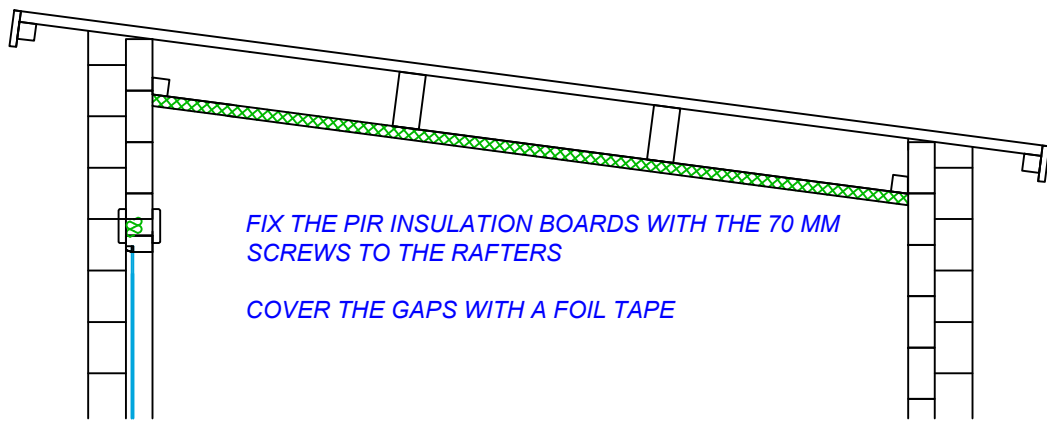
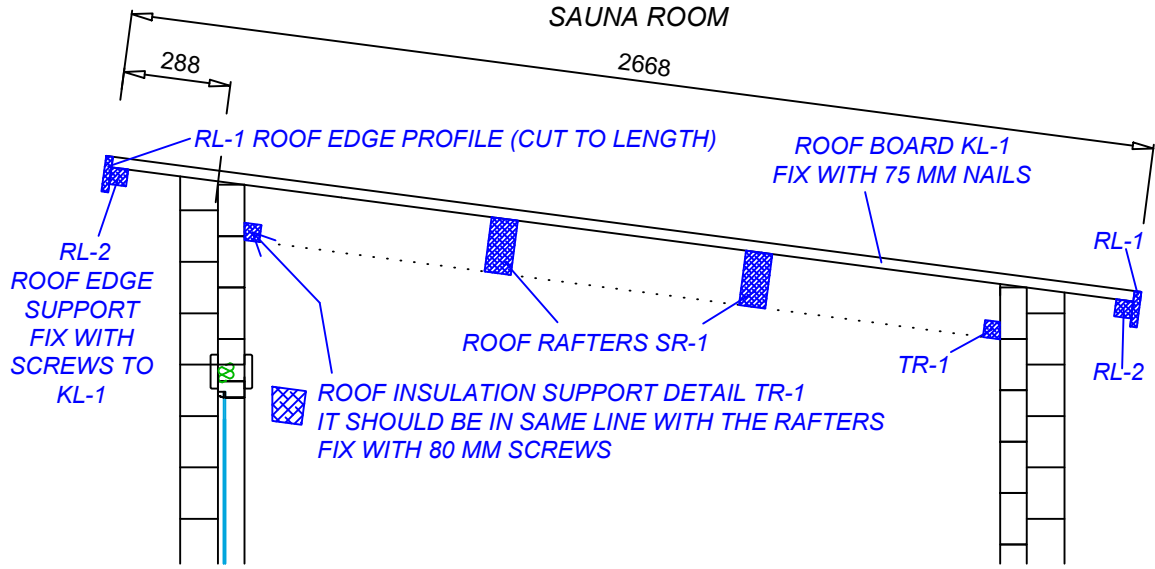

CUT THE HOLE FOR CHIMNEY WHEN USING WOOD-BURNING HEATER (EXTRA DRAWING WITH POSITIONING MEASURES)

WINDOW MOULDINGS 18x95

OUTSIDE AND INSIDE MOULDINGS ARE WITH THE SAME LENGTH
FIX WITH A 40 MM STAINLESS SCREWS

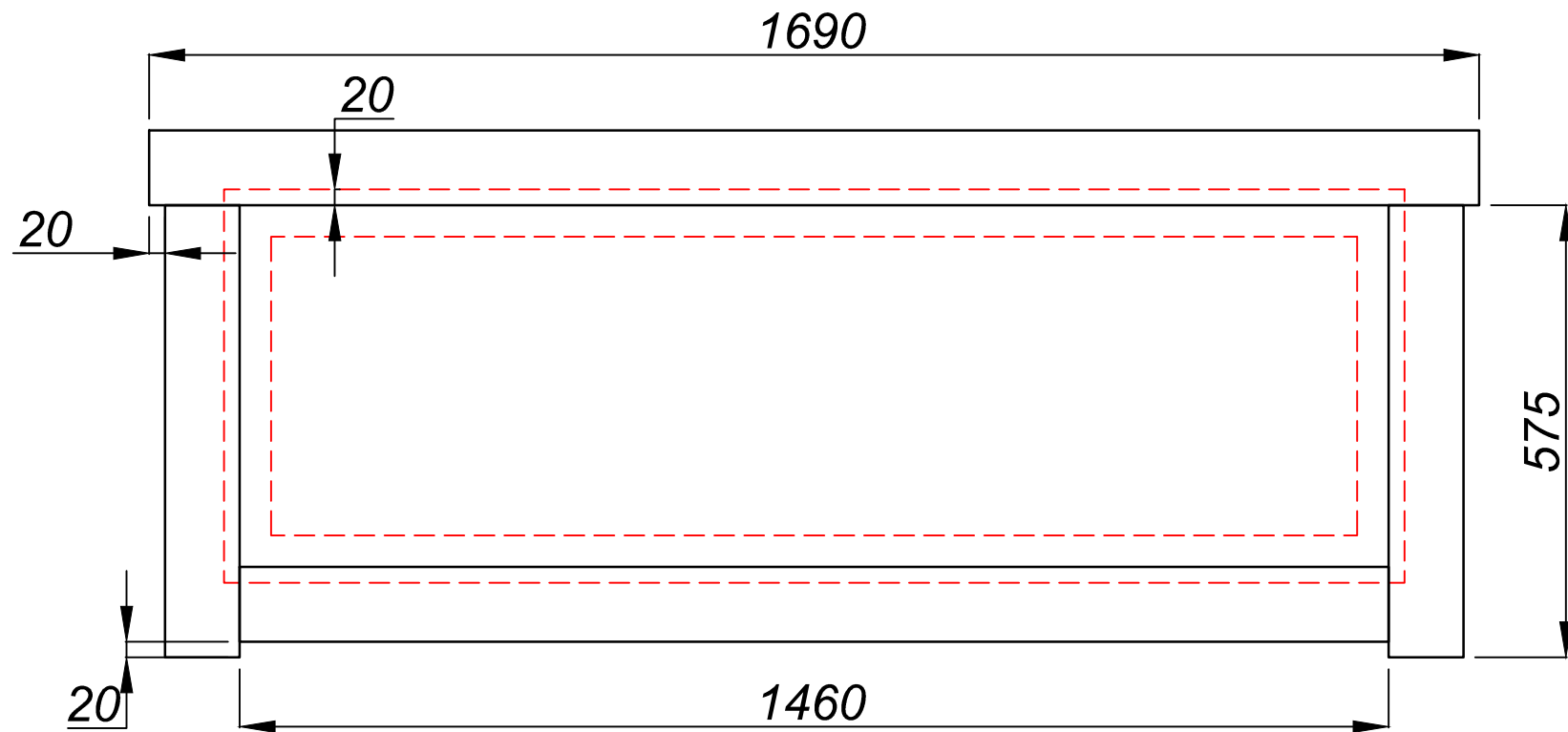

GRID WALL VS-1

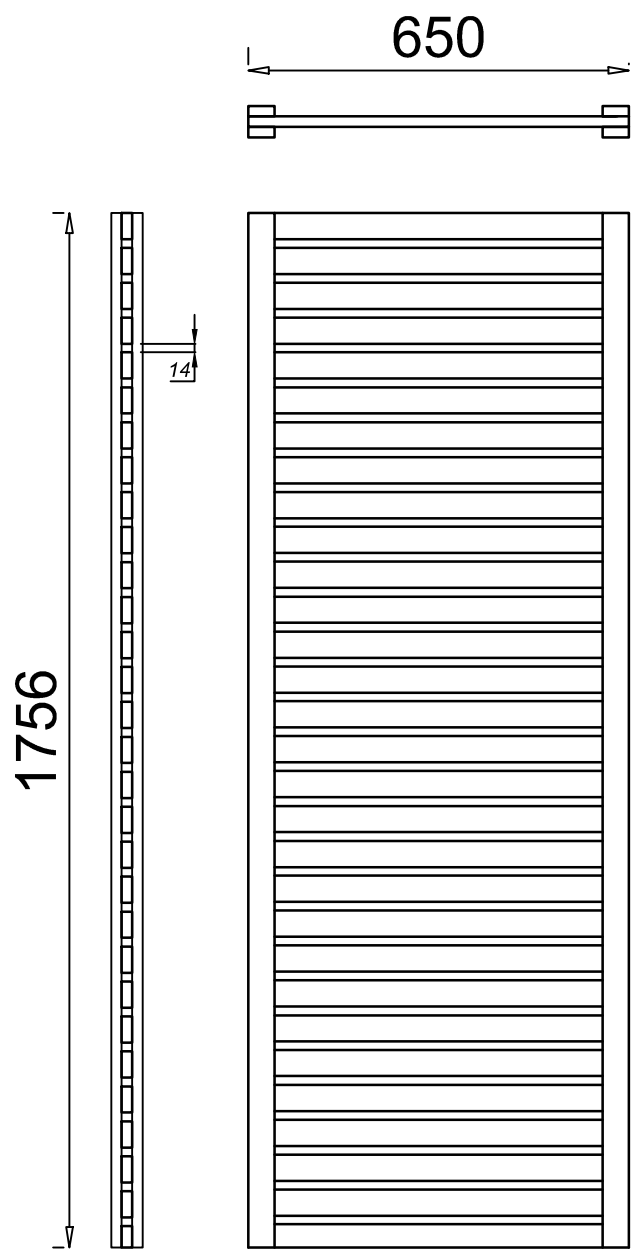

CORNER POST NP-1

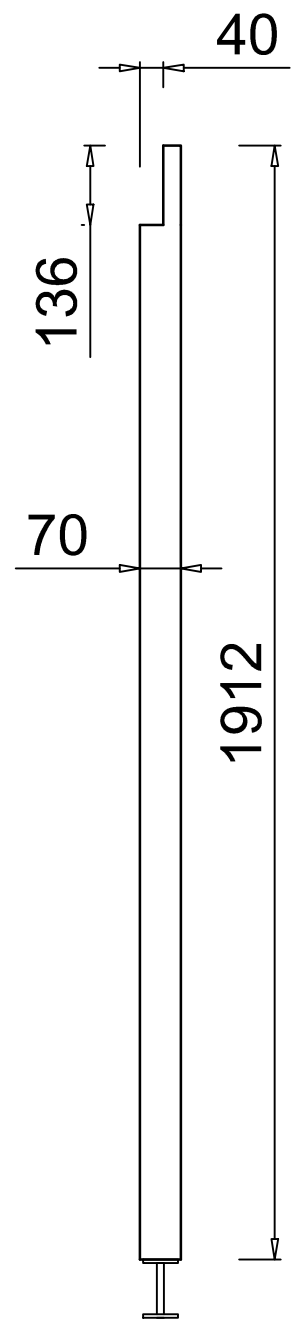

Adjustable levelling bolt

INSTALLATION OF THE GRID

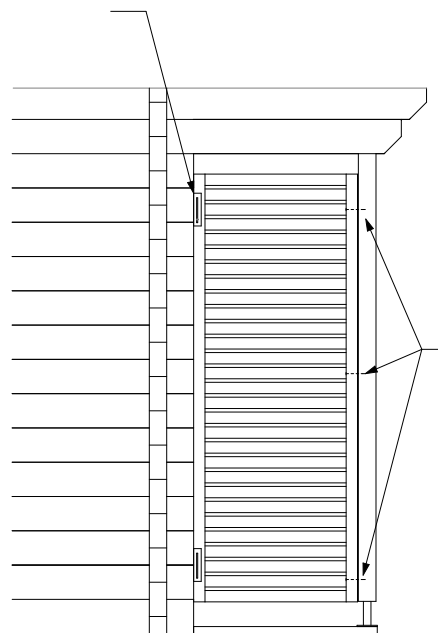
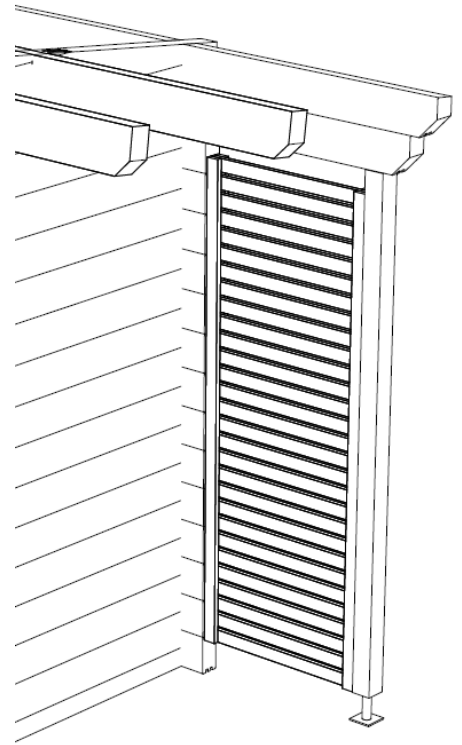

Sliding bracket 35x35x130
Install with 5x40 screws
Use M5 washer with screw to allow the wall logs to sink
(do not tighten the screw 100%)

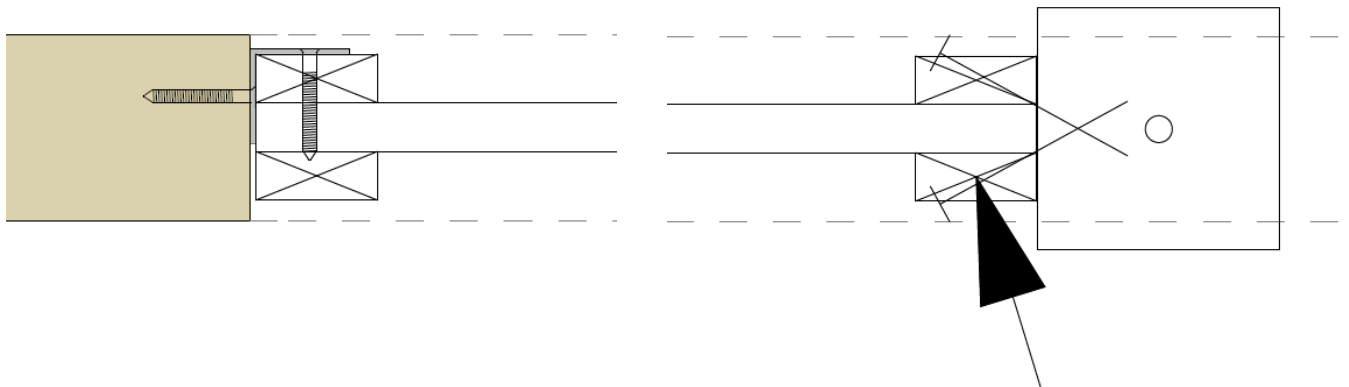

Fix the grid to corner post with a screw 5x80

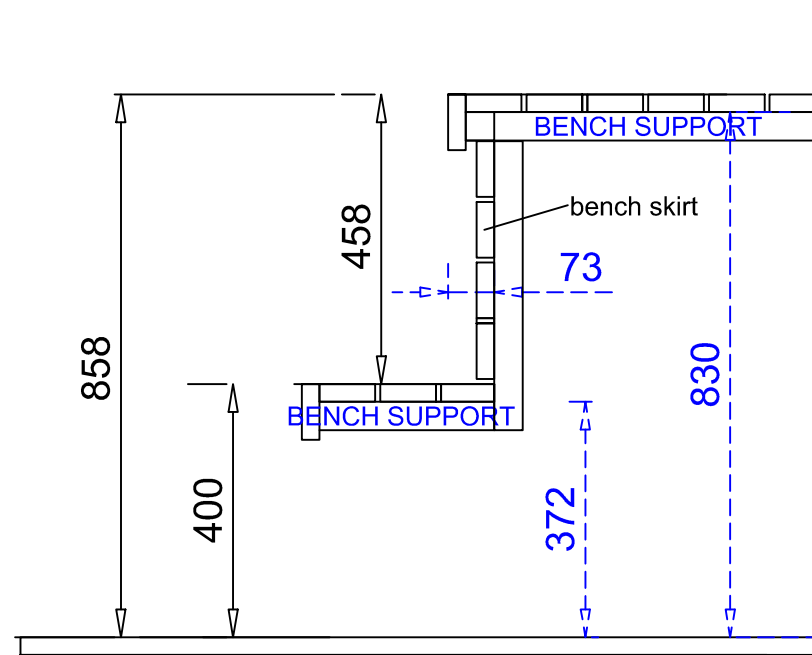

1. FIRST FIX THE BENCH SUPPORTS TO THE WALL
2. THEN LIFT THE BENCHES ON TOP OF THEM
3. FIX THE BENCHES WITH THE 70 MM SCREWS TO THE WALLS AND SUPPORTS
4. USE VERTICAL SUPPORT TO SUPPORT THE BENCH FROM THE MIDDLE

BENCH SET

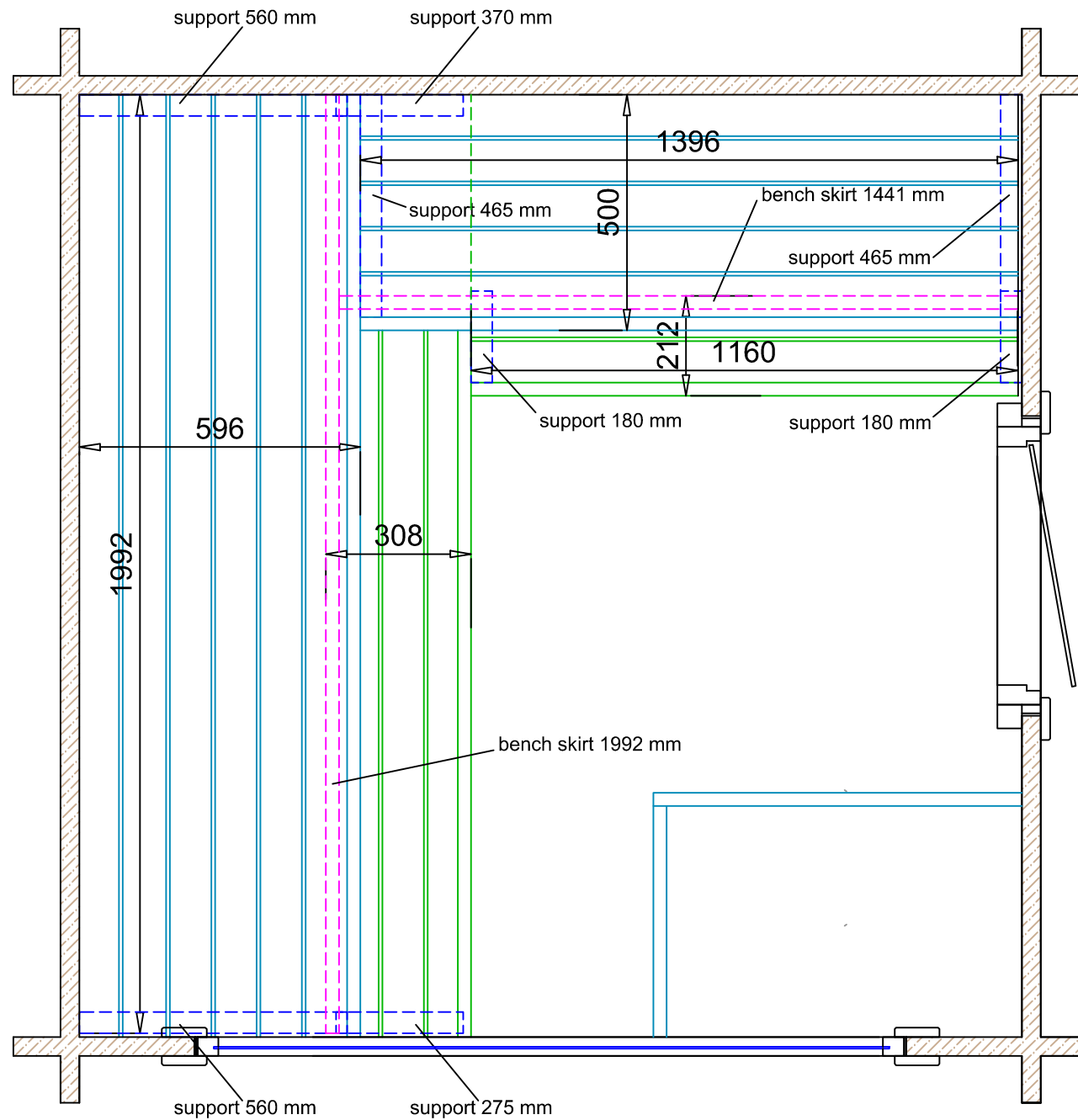

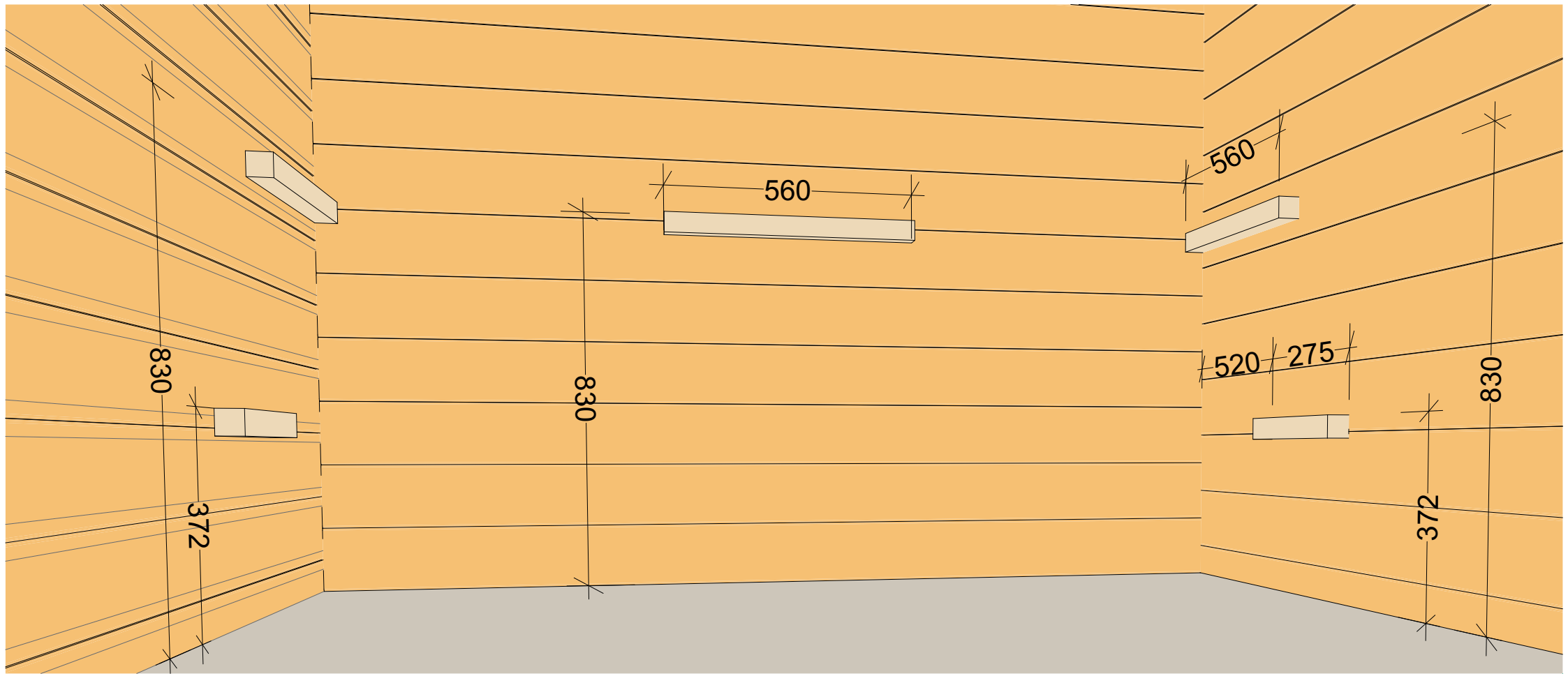

830

372

830

560

520

275

560

372

830

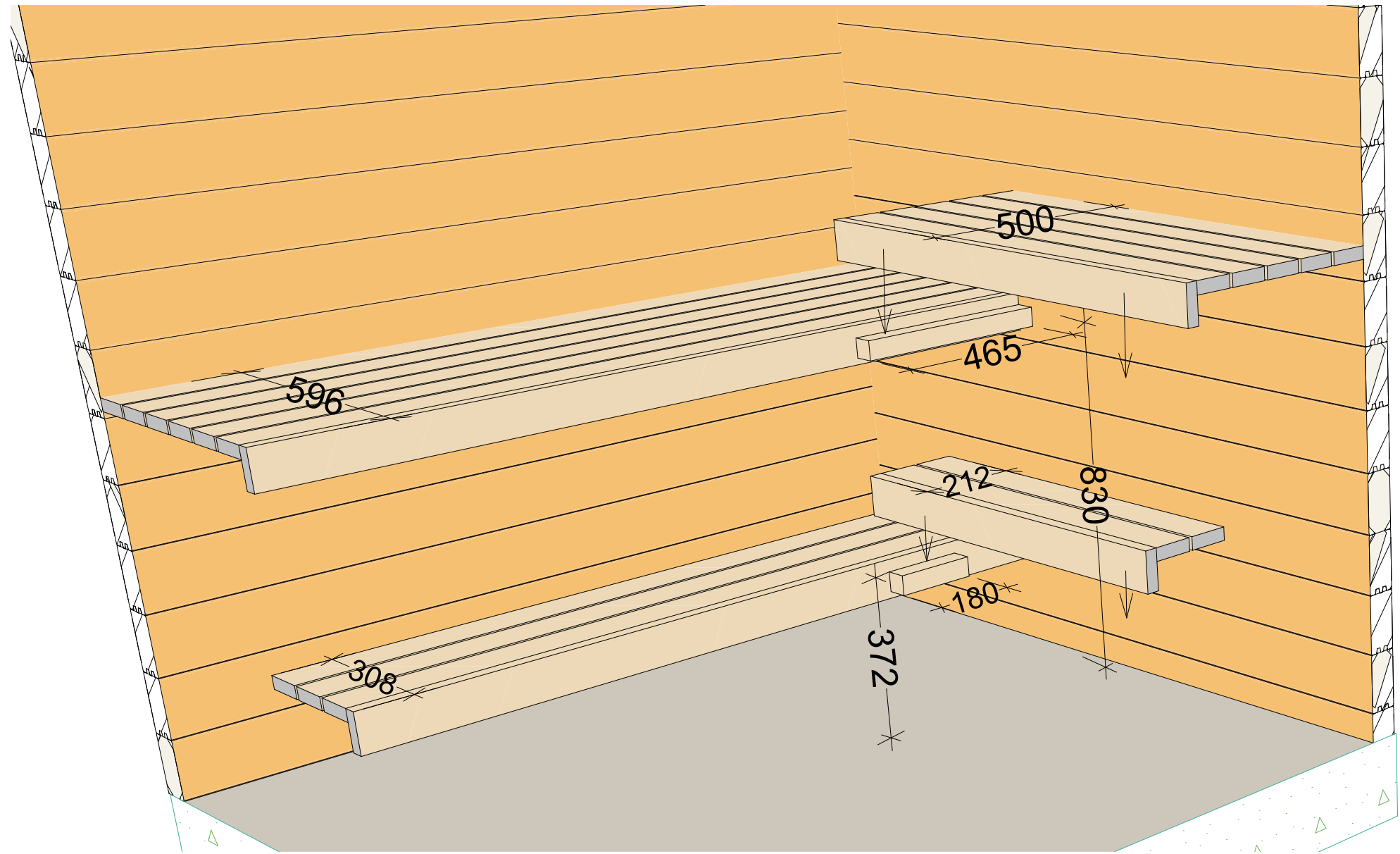

HEATER GUARD

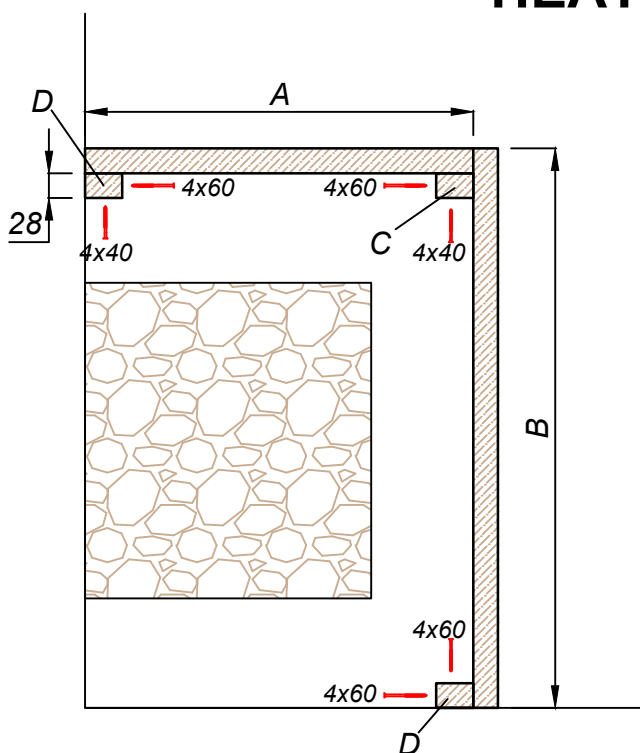

Heater guard DIY package includes:

Detail A: 28x88x640 - 2 pcs

Detail B: 28x88x810 - 2 pcs

Detail C: 28x42x700 - 1 pcs

Detail D: 28x42x350 - 2 pcs

Screw 4x40 - 8 pcs

Screw 4x60 - 16 pcs

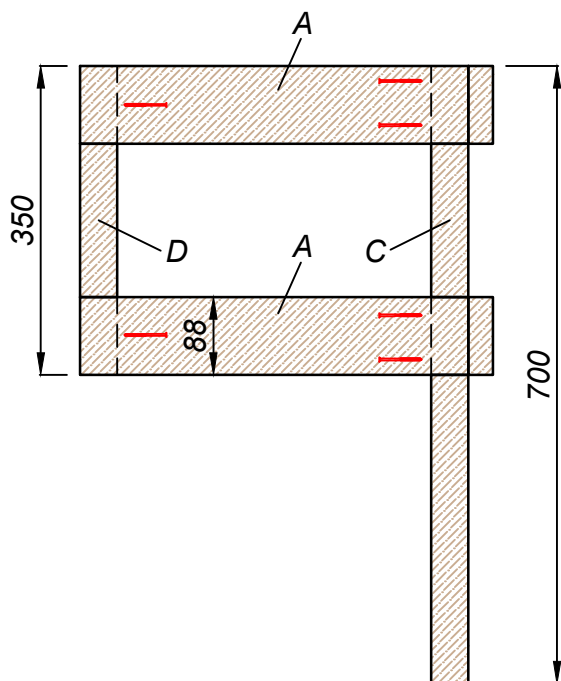

1. Cut the details "A" and "B" to correct measure
2. Fix the details to detail "C" and "D" with the screws
3. Fix the heater guard to the wall
4. **Be sure that safety distances are valid to the heater manual!**

Heater model	A (mm)	B (mm)
ISC 9 kW	440	640
Huum Drop 9 kW	490	810
Huum Hive 9 kW	640	696
Huum Steel 9 kW	520	610