

Linda 28
Art. Nr. 2832296

1/9



21.11.2017

Groundplan - Grundplan - Plan de masse -
 Planimetria - Plattegrond - Põhiplaan

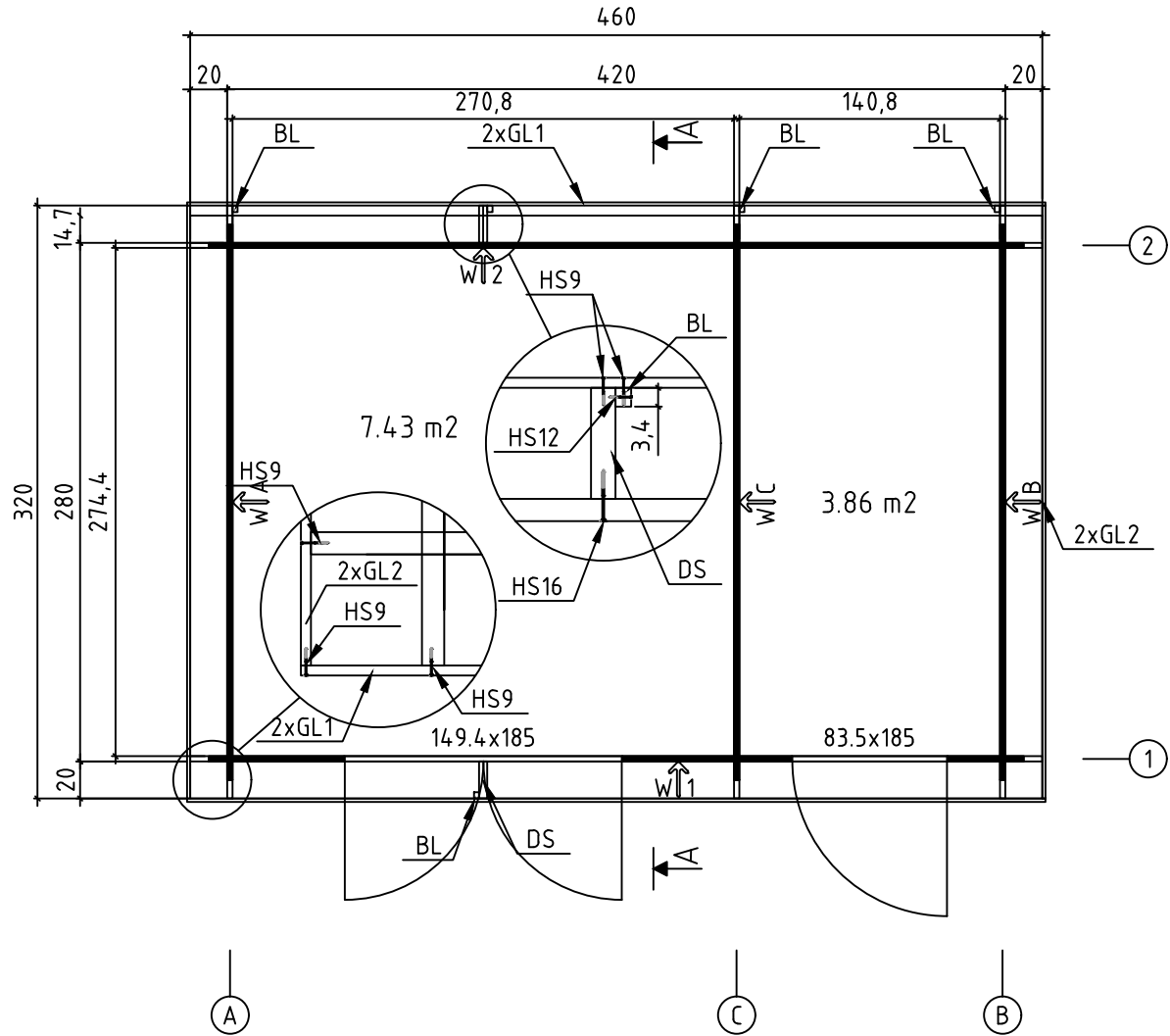

Roof plan - Dach-plan - Plan du toit - Piano del tetto - Dak plattegrond - Katuseplaan

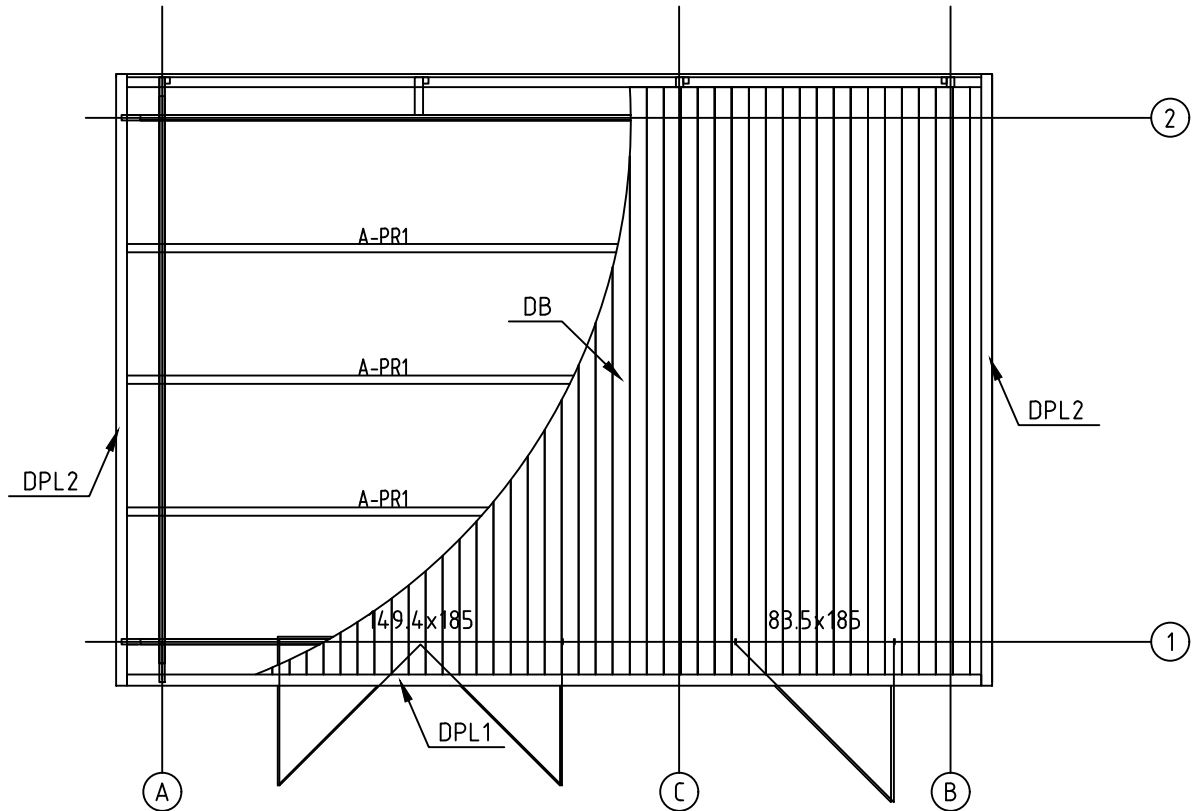

Cross section - Schnitt - Vu de coupe - Sezione trasversale - Doorsnede - Lõige A - A

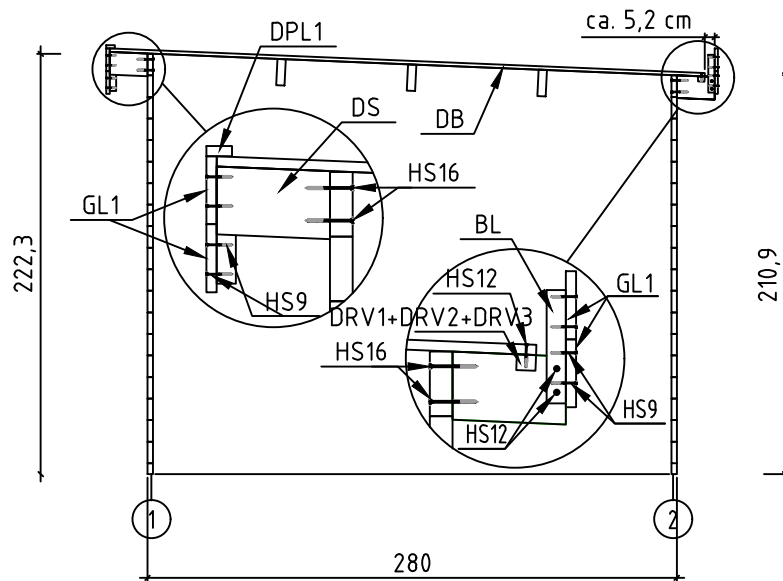



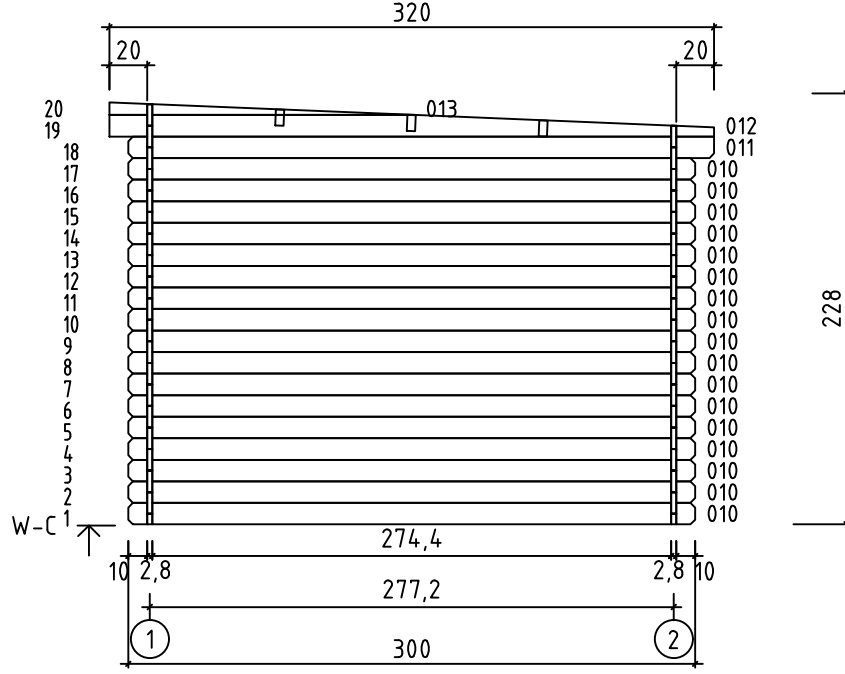
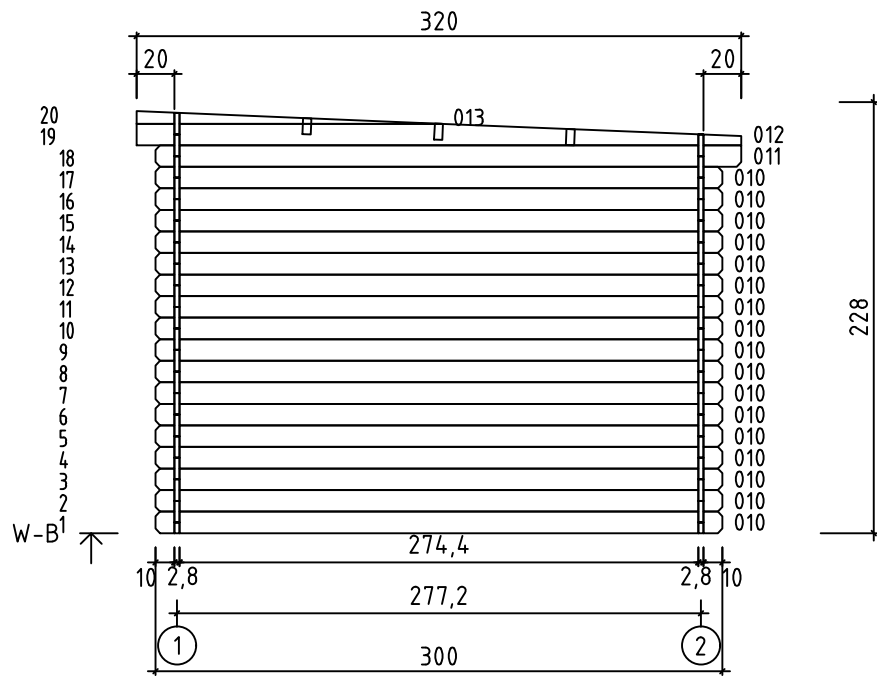
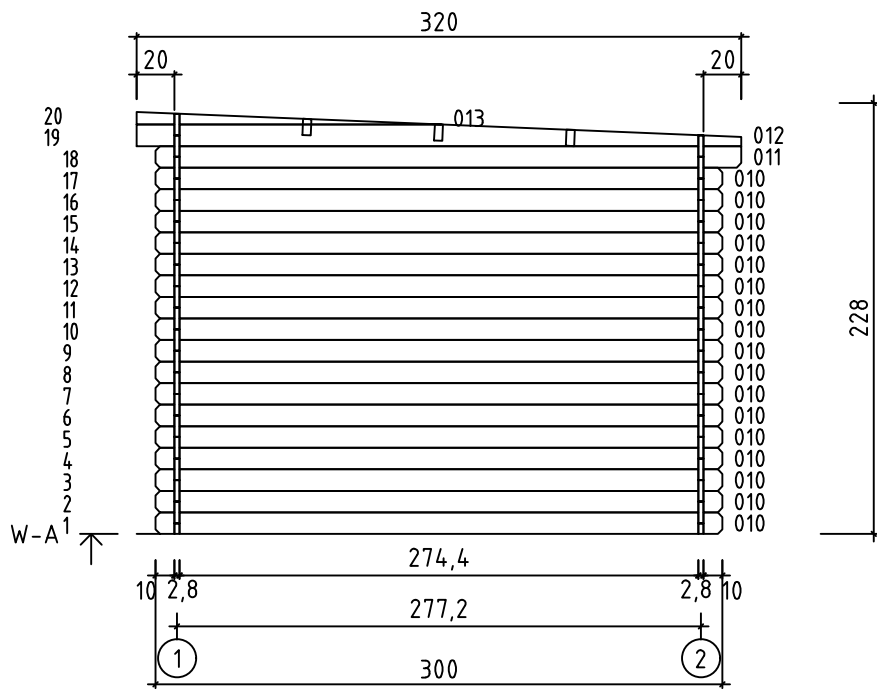



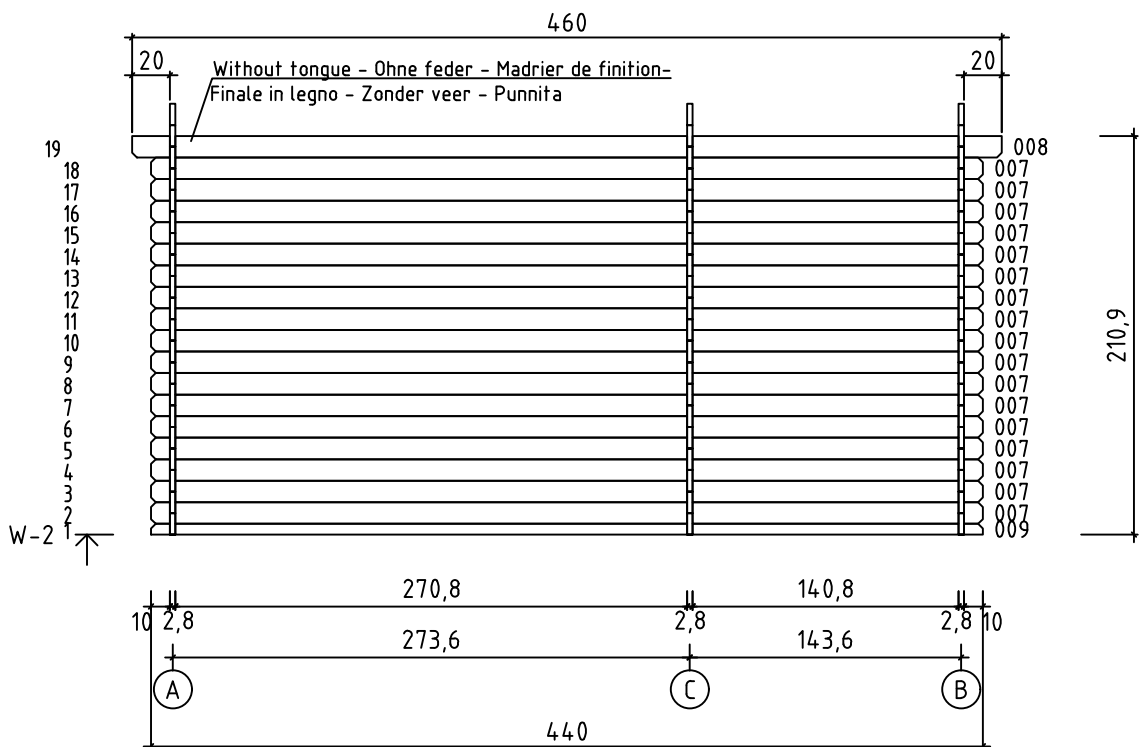
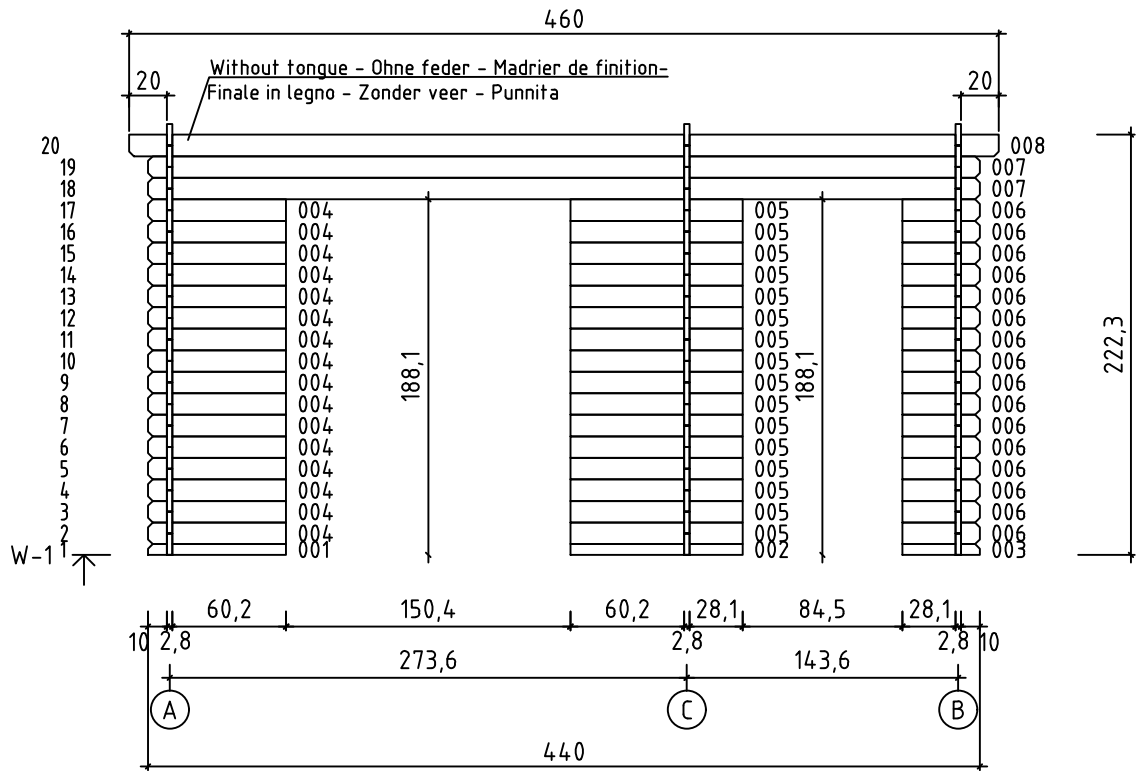

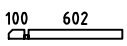
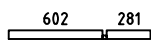

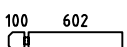
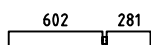

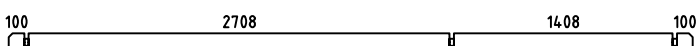
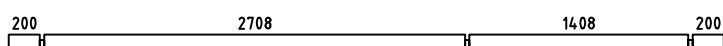
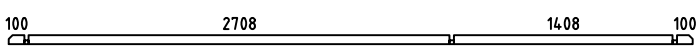
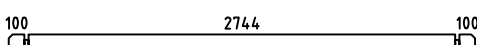
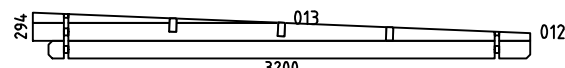
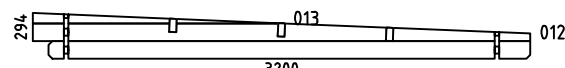
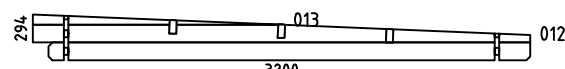
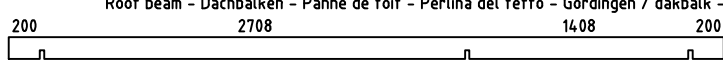
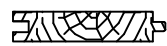



Art. Nr. 2832296

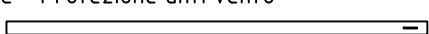

Art. Nr. 2832296

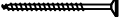
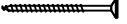
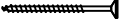
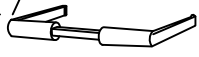

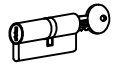
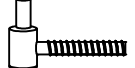

Pos	21.11.2017 Piece list - Stückliste - Liste des pièces - Elementi - Stuklijst - Tükitalabel Art. Nr. 2832296 6/9	Q	P (mm)	L (mm)
001		1	28x57	730
002		1	28x57	911
003		1	28x57	409
004		16	28x114	730
005		16	28x114	911
006		16	28x114	409
007		19	28x114	4400
008		2	28x114	4600
009		1	28x57	4400
010		51	28x114	3000
WA-1		1		
WB-1		1		
WC-1		1		
A-PR1	Roof beam - Dachbalken - Panne de toit - Perlina del tetto - Gordingen / dakbalk - Pärilin 	3	44x140	4600
DB	Roof boards - Dachbretter - Voliges - Perlina per tetto - Dakhout - Katuselaud 	52	90x18	3150
DPL 2	Roofing felt fillet - Dachpappenleiste - Baguette de fixation du feutre bitumeux - Asse per fissaggio guaina bituminosa - Afdeklijst asfaltpapier - Katusepapiliist 	2	18x58	3236
DPL 1	Roofing felt fillet - Dachpappenleiste - Baguette de fixation du feutre bitumeux - Asse per fissaggio guaina bituminosa - Afdeklijst asfaltpapier - Katusepapiliist 	1	18x58	4520
DRV-1	Roof edge reinforcement - Dachrandverstärkung - Corniere de renfort de bord de toit - Rinforzo x tetto - Dakrand versterking - Räästatugevdus 	2	28x34	200
DRV-2	Roof edge reinforcement - Dachrandverstärkung - Corniere de renfort de bord de toit - Rinforzo x tetto - Dakrand versterking - Räästatugevdus 	2	28x34	1323
DRV-3	Roof edge reinforcement - Dachrandverstärkung - Corniere de renfort de bord de toit - Rinforzo x tetto - Dakrand versterking - Räästatugevdus 	1	28x34	1390
KFS-1	Storm protection - Sturmleiste - Latte anti-tempete - Protezione anti vento - Stormverankering / beveiliging - Tormikinnitusliist 	4	22x45	2050
BL	Fixing slat for distance spacers - Befestigungsleiste - Renforts planches de rives - Stecca per fissare i distanziatori - Bevestigingslat afstandhouders - Viilulaua kinnitus 	5	28x34	200
DS	Distance spacers for gable moulding - Dachstützen - Supports extension toiture - Distanziatori per la modanatura del timpano - Daksteun / afstand houder - Viilulaua tugiklots 	2	44x140	205

Pos	21.11.2017 Piece list - Stückliste - Liste des pièces - Elementi - Stuklijst - Tükítabel 1494x1850 TUK.1.100.SVV.MMc SGC 8/9	Q	P (mm)	L (mm)
HS4	Screw for door fillet - Schraube zur Befestigung Türleiste - Vis pour fixation baguette d'arrêt de porte - Viti per massellino della porta - Schroef voor deurlijst - Kruvi ukse kokkuvaltšiliistule 	5	3x30	
HS16	Screw for door jamb - Schraube für Türrahmen - Vis de fixation partie haute avec montants du cadre de porte - Viti x fissaggio montanti porte - Schroef voor deurkozijn - Kruvi ukse lengile 	4	5x90	
HS25	Screw for doorstep - Schrauben für Schwelle - Vis pour fixation barre de seuil - Vite per soglia della porta - Schroef voor deurdorpel - Kruvi lävepakule 	3	4.5x65	
TL4	Door handle fittings - Türgriff - Poignée de porte - Maniglie - Deurhendel / klink - Ukse käepide 	1		
TL5	Set of door lock covers - Schlossblenden - Set de garnitures de porte - Copertura serrature - Slot sluitplaat set - Ukse lukuplaat 	1		
	Cylinder lock - Zylinderschloss - Barillet de porte - Serratura - Cylinder slot - Ukse lukusüdamik 	1	30x35	
	Male bolt hinge for door - Türband - Partie male de paumelle de porte - Cerniera anube x porta - Scharnier bout - Ukse polthing isane 	6		
	Striker for barrel bolt - Hülse für Grendelriegel - Gache au sol du targette - Boccola per fermo della porta - Huls voor vergrendelingschuif - Vasturaud ukse servariivile 	2		

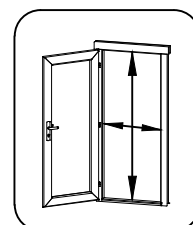
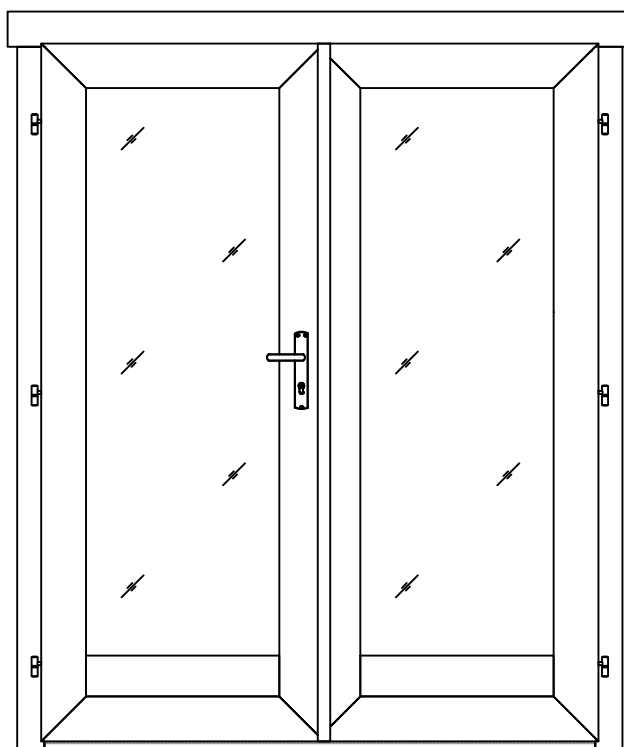
Glass size - Glasgröße - Taille de la vitre - Misura del vetro - Glas afmeting - Klaasi mõõt: 514x1486 mm

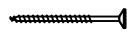
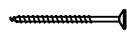

1394x1768 mm

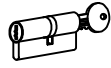
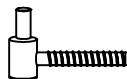
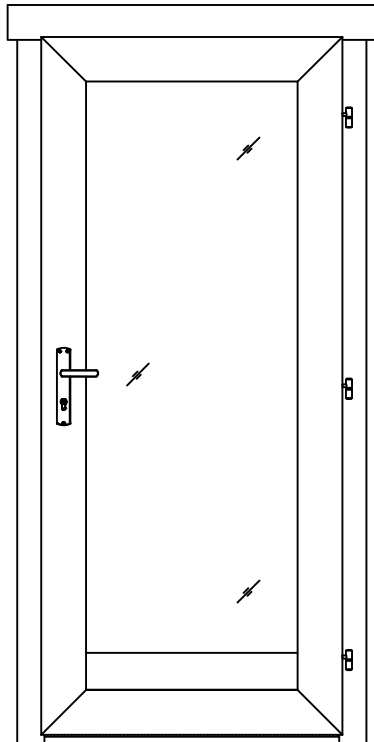
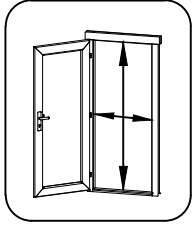
Pos	21.11.2017 Piece list - Stückliste - Liste des pièces - Elementi - Stuklijst - Tükitabel 835x1850 UK.1.100.MVP.MMa MGC 9/9	Q	P (mm)	L (mm)
HS25	Screw for doorstep - Schrauben für swelle - Vis pour fixation barre de seuil - Vite per soglia della porta - Schroef voor deurdorpel - Kruvi lävepakule 	2	4.5x65	
HS16	Screw for door jamb - Schraube für türrahmen - Vis de fixation partie haute avec montants du cadre de porte - Viti x fissaggio montanti porte - Schroef voor deurkozijn - Kruvi ukse lengile 	4	5x90	
TL4	Door handle fittings - Türgriff - Poignée de porte - Maniglie - Deurhendel / klink - Ukse käepide 	1		
TL5	Set of door lock covers - Schlossblenden - Set de garnitures de porte - Copertura serrature - Slot sluitplaat set - Ukse lukuplaat 	1		
	Cylinder lock - Zylinderschloss - Barillet de porte - Serratura - Cylinder slot - Ukse lukusüdamik 	1	30x35	
	Male bolt hinge for door - Türband - Partie male de paumelle de porte - Cerniera anube x porta - Scharnier bout - Ukse polthing isane 	3		
<p>Glass size - Glasgröße - Taille de la vitre - Misura del vetro - Glas afmeting - Klaasi mõõt: 561x1486 mm</p>   <p>735x1768 mm</p>				