

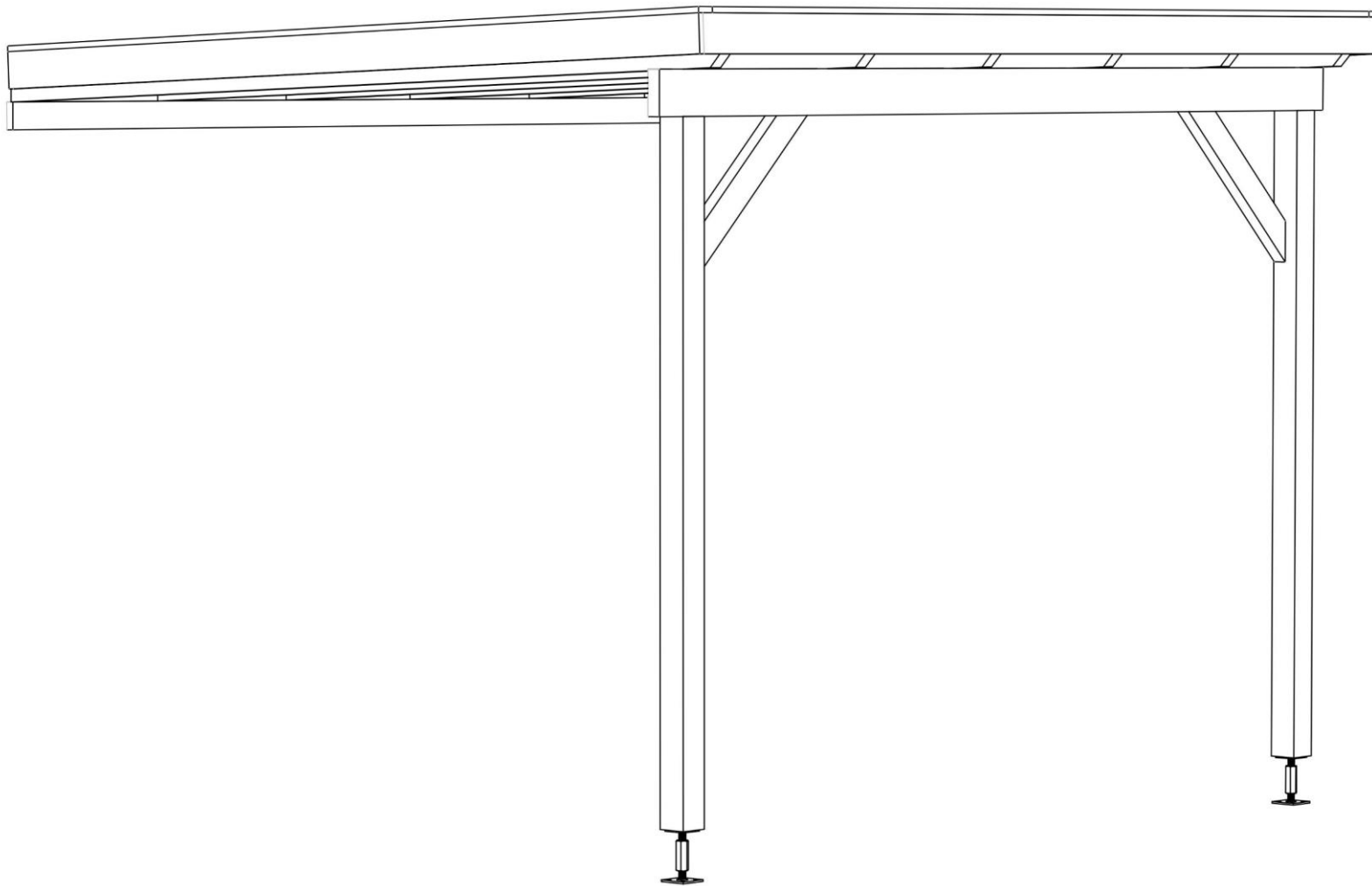

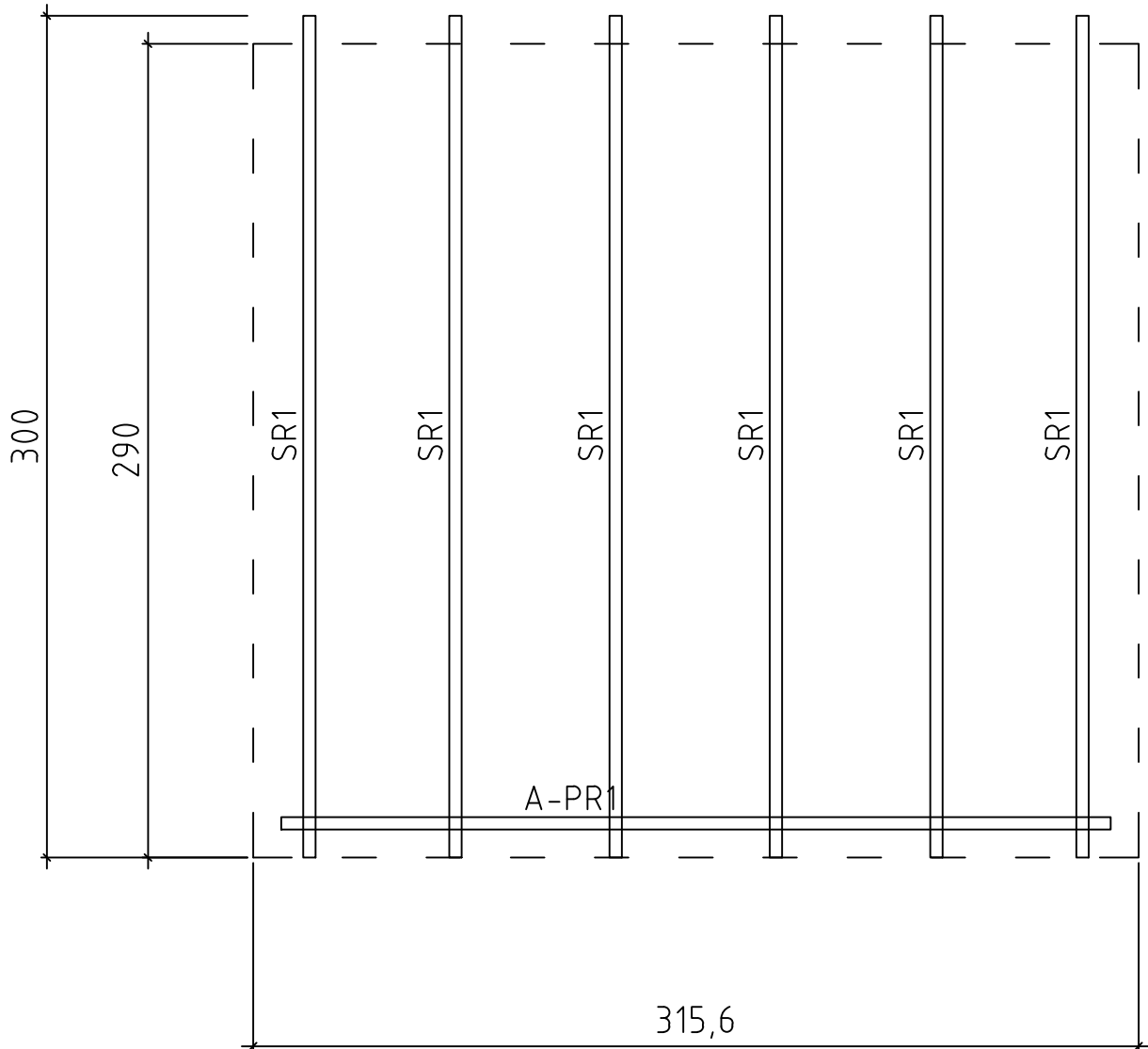







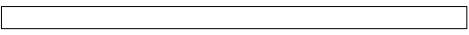











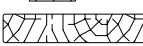

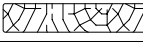



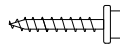

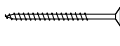
Anbau A1
Art. Nr. 9909300
1/9

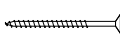
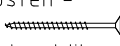

Roof plan - Dach-plan - Plan du toit - Piano del tetto -
Dak plattegrond - Katuseplan



Pos	01.03.2023	Piece list - Stückliste - Liste des pièces - Elementi - Stuklijst - Tükitalabel Art. Nr. 9909300	3/9	Arv	Profiil (mm)	Pikkus (mm)
SR1 45031		Rafter - Dachsparren - Chevron - Trave - Dak spar - Sarikas 		6	44x140	3008
A-PR1 45090		Roof beam - Dachbalken - Panne de toit - Perlina del tetto - Gordingen / dakbalk - Pärilin   -Painted		1	44x140	2956
RB 45091		Roof boards - Dachbretter - Voliges - Perlina per tetto - Dakhout - Katuselaud 		33	90x15	3156
DPL-1 45035		Roofing felt fillet - Dachpappenleiste - Baguette de fixation du feutre bitumeux - Asse per fissaggio guaina bituminosa - Afdeklijst asfaltpapier - Katusepapiilist  -Painted 		2	18x58	2903
DPL-2 44803		Roofing felt fillet - Dachpappenleiste - Baguette de fixation du feutre bitumeux - Asse per fissaggio guaina bituminosa - Afdeklijst asfaltpapier - Katusepapiilist  -Painted 		1	18x58	3076
RS 45092		Railing strip - Begrenzungsleiste - Rembarde - Sbarra - Afscheidingslijst - Piirdelaud  -Painted 		1	18x90	2992
P 45037		Post - Pfosten - Poteau - Piede registrabile - Stijl - Post  -Painted 		2	90x90	2180
TB1 45039		Fascia board - Traufbrett - Bandeau de toit - Finitura lati tetto - Gevellijst -  -Painted 		2	18x120	2903
TB2 44808		Fascia board - Traufbrett - Bandeau de toit - Finitura lati tetto - Gevellijst -  -Painted 		1	18x120	3156
DRV-1 45041		Roof edge reinforcement - Dachrandverstärkung - Corniere de renfort de bord de toit - Rinforzo x tetto - Dakrand versterking - Räästatugevdus  -Painted 		2	28x34	2903
B 45042		Beam - Balkenlage - Solive(s) - Trave - Balk (gording) - Tala   -Painted		2	44x95	800
HS28 5602		Screw for fascia sheet - Schraube für abschlussprofil - Vis pour profil de finition métallique pour débord de toiture - Viti per fissare i folgi di gronda - Schroef voor afsluit (afdek)profiel - Katusekruvi 		52	4.8x28	
HS12 5109		Screw for fascia boards - Schrauben für traufbretter - Vis pour fixation bandeau de toit - Viti x striscia del tetto - Schroef voor gevellijst - Kruvi räästalauale 		26	4x40	
HS12 5109		Screw for roof edge reinforcement - Schrauben für dachrandverstärkung - Vis pour fixation corniere renfort de bord de toit - Viti x rinforzo bordo tetto - Schroef voor dakrand versterking - Kruvi räästatugevdusele 		14	4x40	
HS18 5113		Screw for roof beams - Schrauben für dachbalken - Vis pour fixation pannes de toit - Viti per perline del tetto - Schroef voor gordingen / dakbalken - Kruvi pärlinitele 		16	5x120	
HS16 5115		Screw for post - Schrauben für pfosten - Vis de fixation des poteaux - Viti per inviare - Schroef voor stijlen - Kruvi postile 		8	5x90	
HS23 5121		Screw for roof beams - Schrauben für dachbalken - Vis pour fixation pannes de toit - Viti per perline del tetto - Schroef voor gordingen / dakbalken - Kruvi pärlinitele 		6	6x180	
HS19 5117		Screw for roof beams - Schrauben für dachbalken - Vis pour fixation pannes de toit - Viti per perline del tetto - Schroef voor gordingen / dakbalken - Kruvi pärlinitele 		10	6x40	
HS20 5118		Screw for post height adjustment - Schrauben für regulierungsschraube für pfosten - Vis de fixation de support réglable de poteau - Viti per fissare ed aggiustare l'altezza del palo verticale - Schroef voor hoogte instelling stijlen - Kruvi vajumispoldite 		8	6x50	
NF4 5137		Zn nail for roof - Zn nägel für dachbretter - Pointe pour fixation voliges de toit - Chiodi x perline tetto - Spijker(nagel) voor dakhout - Nael katuselauale 		204	2x50	
NF5 5145		Zn nail for roofing felt fillet - Zn nägel für dachpappenleiste - Pointe pour baguette de fixation feutre bitumeux - Chiodi x carta bituminosa x tetto - Spijker(nagel) voor asfaltpapier afdeklijst - Papiilistunael 		21	2x40	
FS 44293		Fascia sheet - Abschlussprofil - Profil de finition métallique pour débord de toiture - Scossalina di protezione dall'acqua per bordo di legno - Afdek profiel / boordprofiel - Räästaplekk 		2		3100
PHA 34582		Post height adjustment - Regulierungsschraube für pfosten - Support réglable de poteau - Piede registrabile in altezza - Stelschroef voor stijlpost - Vajumispolt 		2	D20	

Art. Nr. 9909300

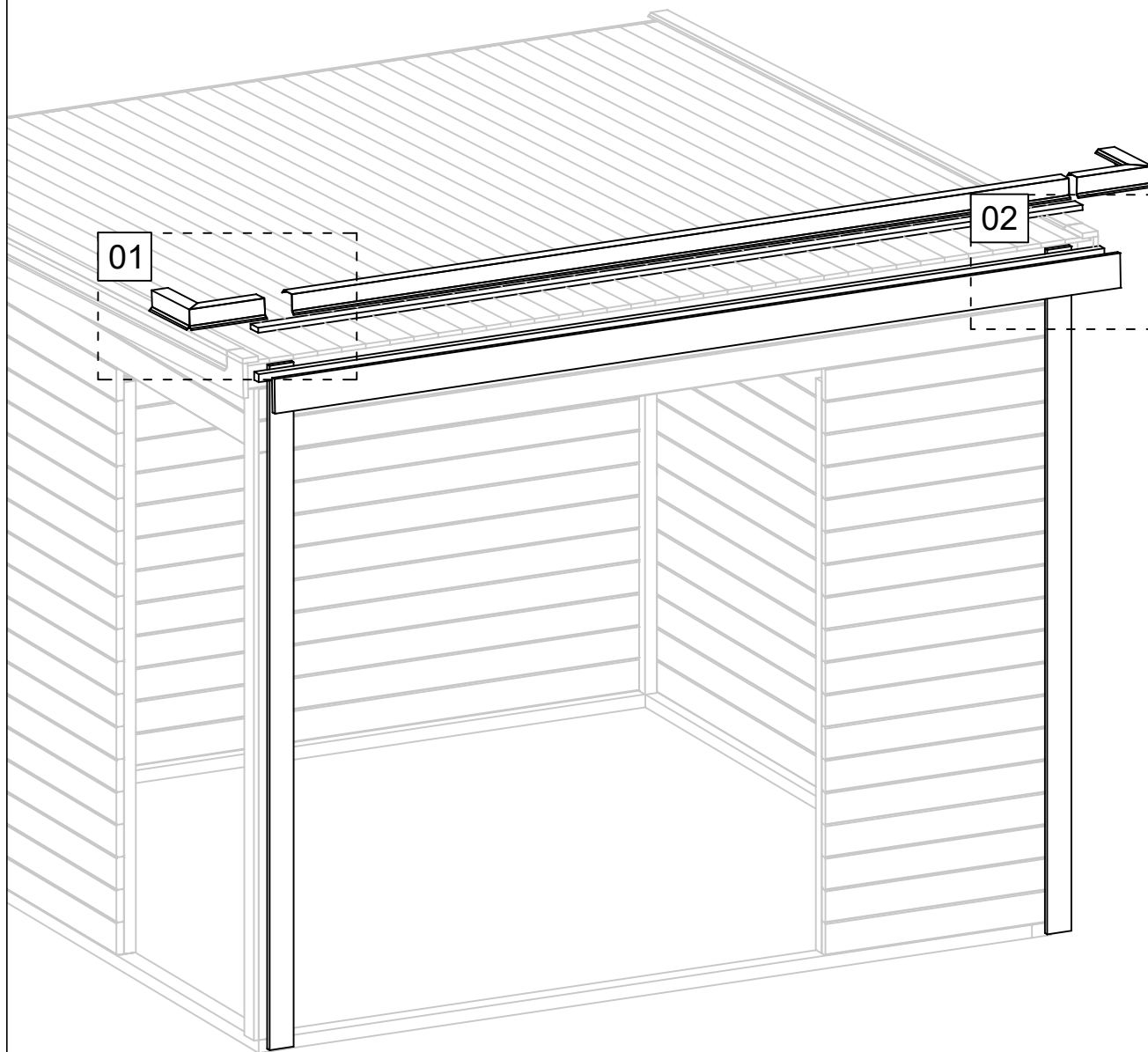

01



02

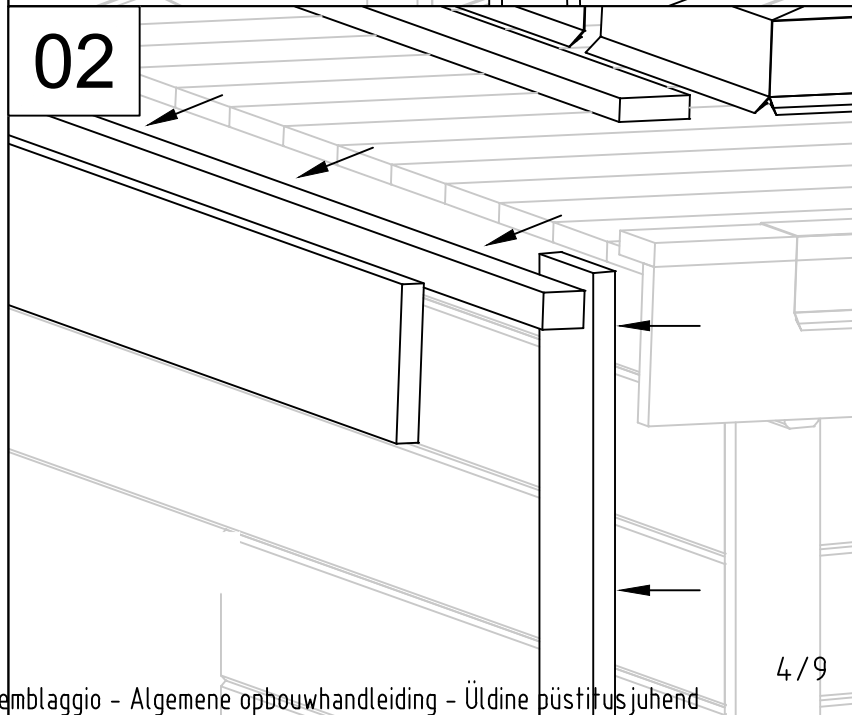

Art. Nr. 9909300

03

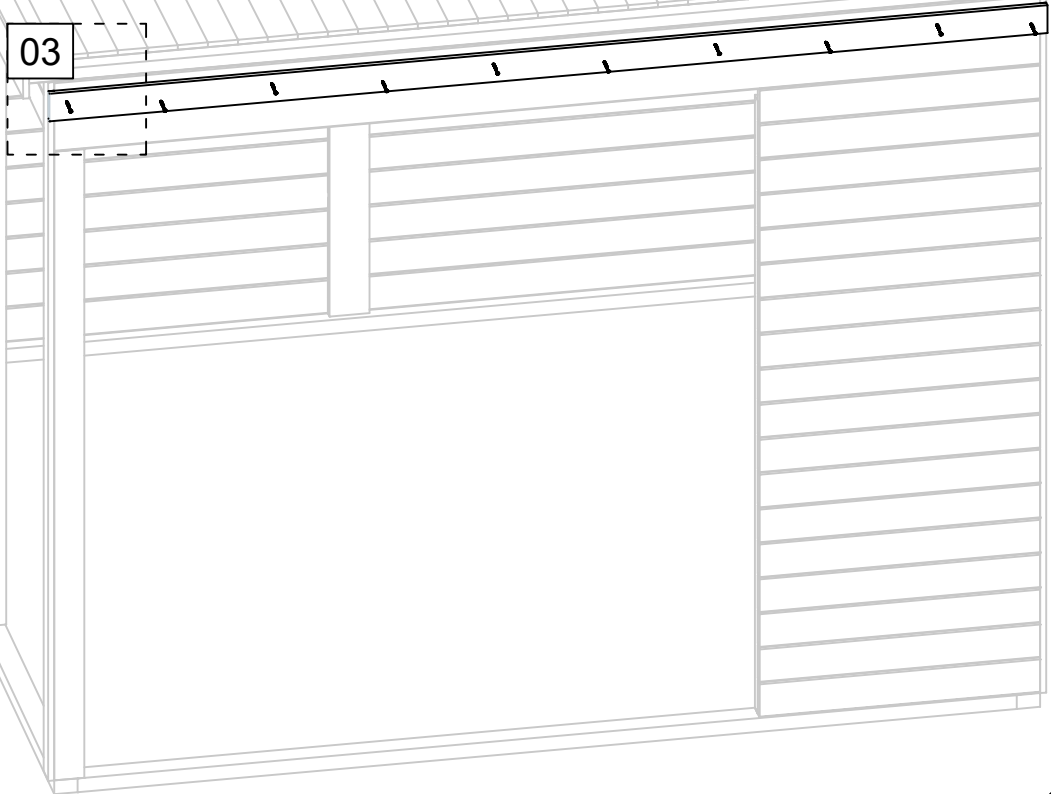

03

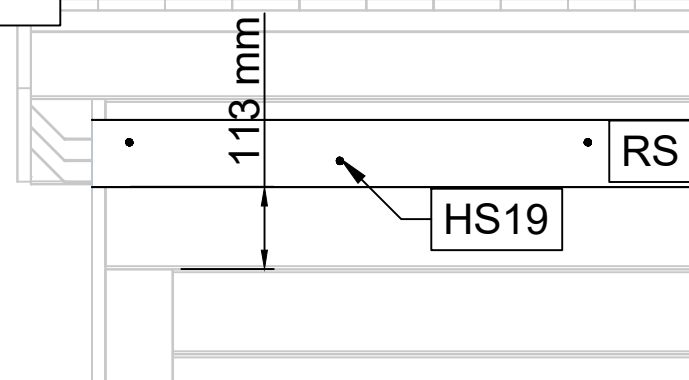

04

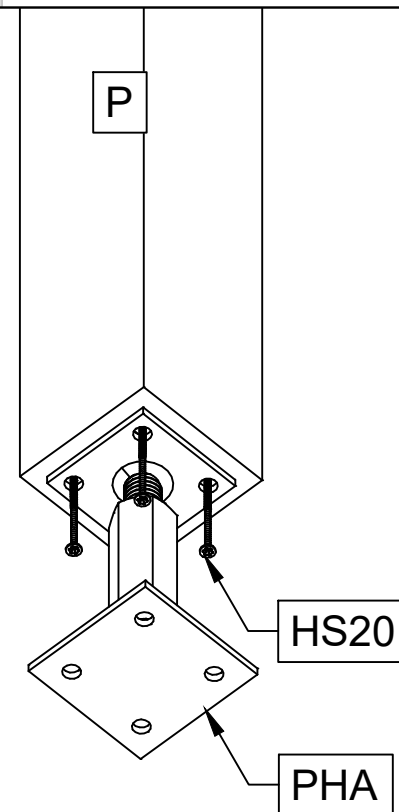

Art. Nr. 9909300

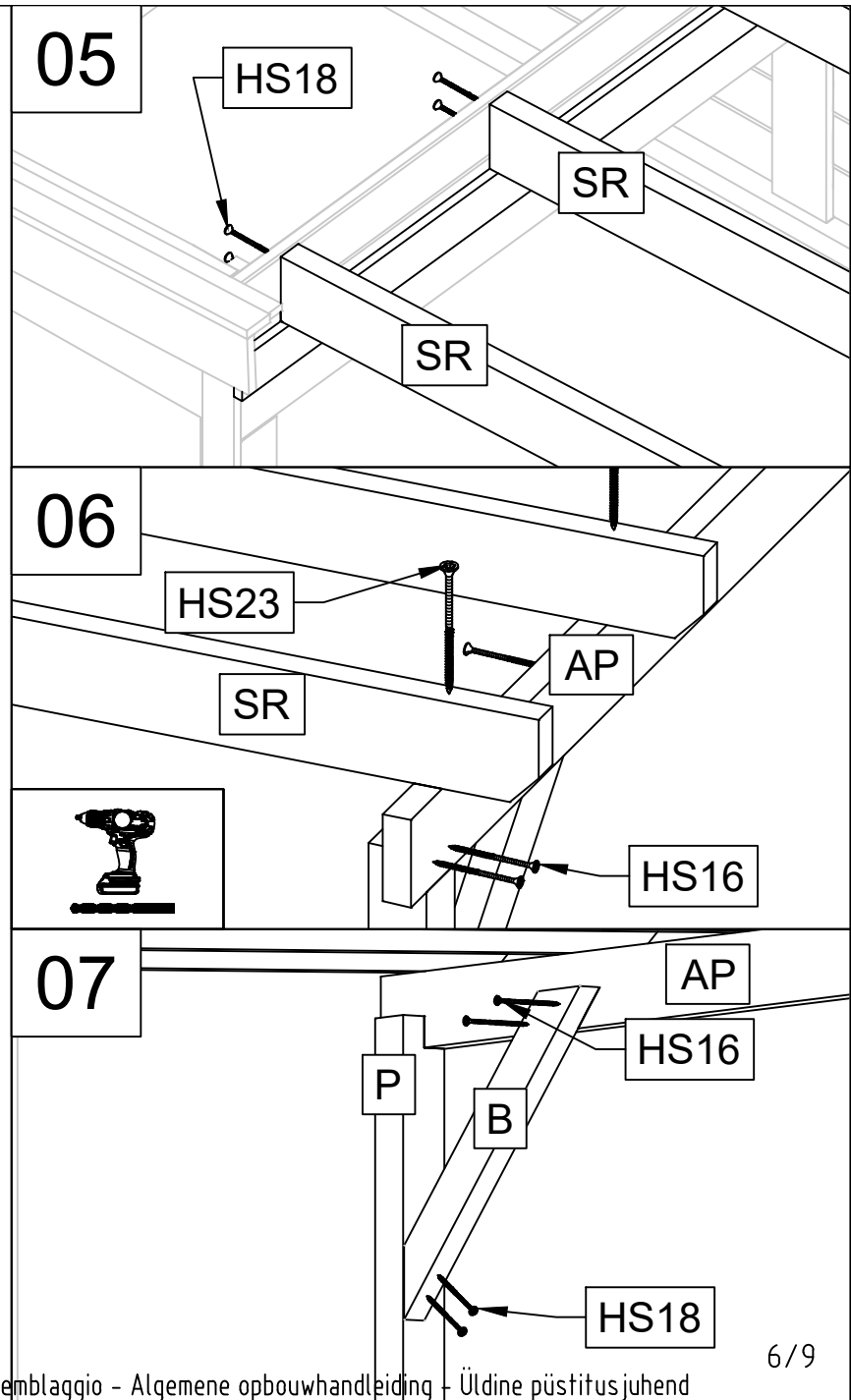
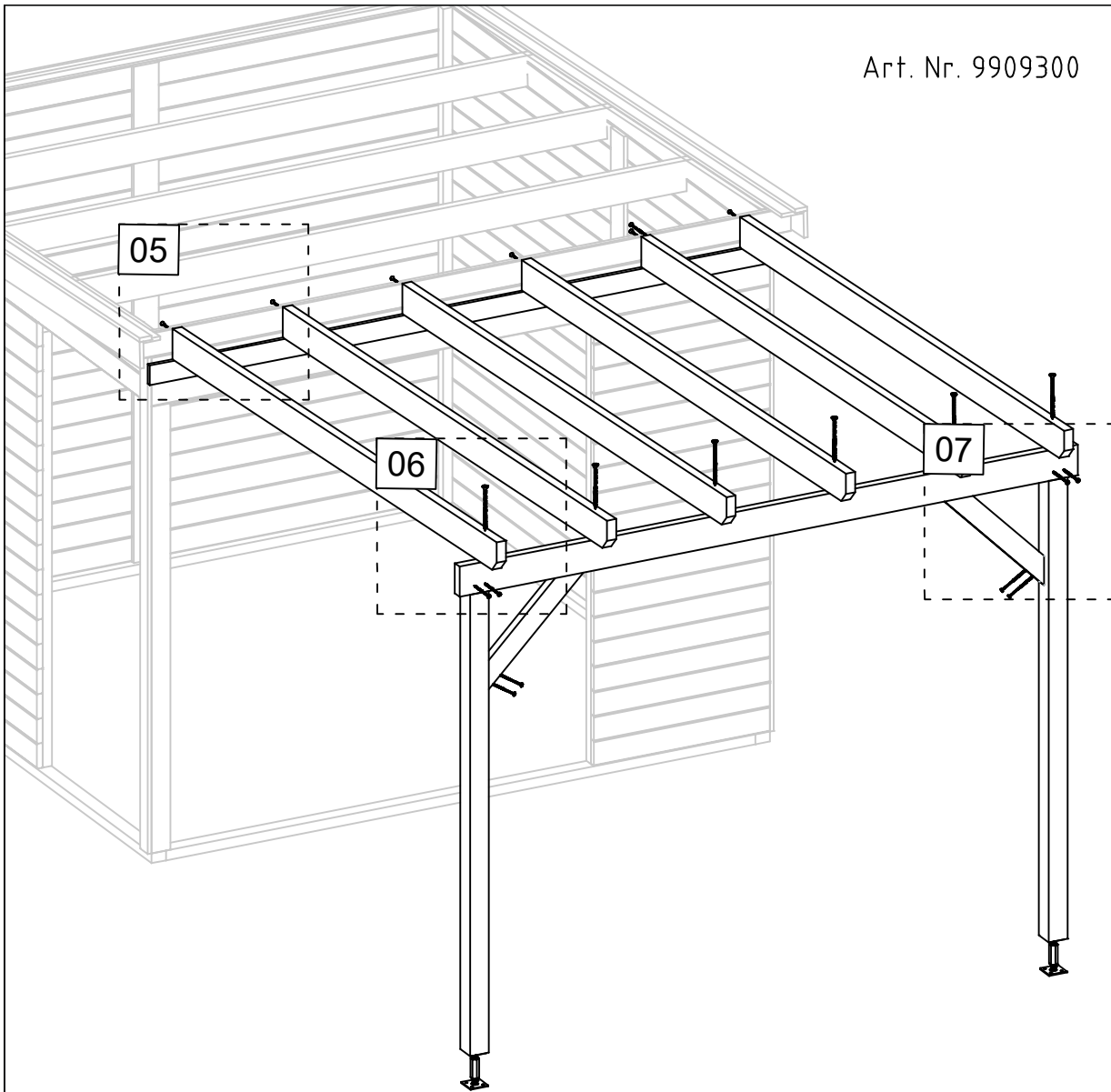

Art. Nr. 9909300

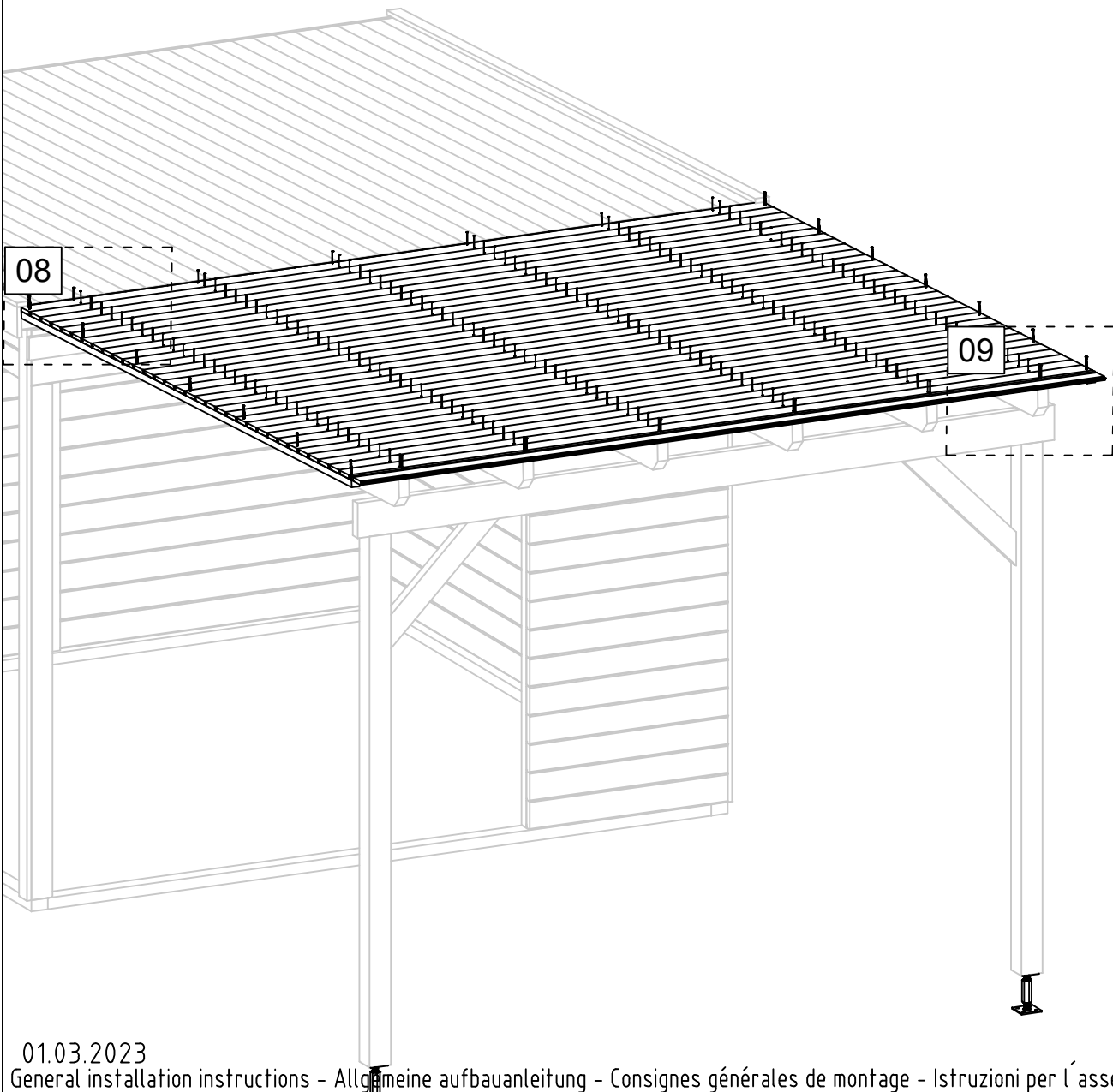

08

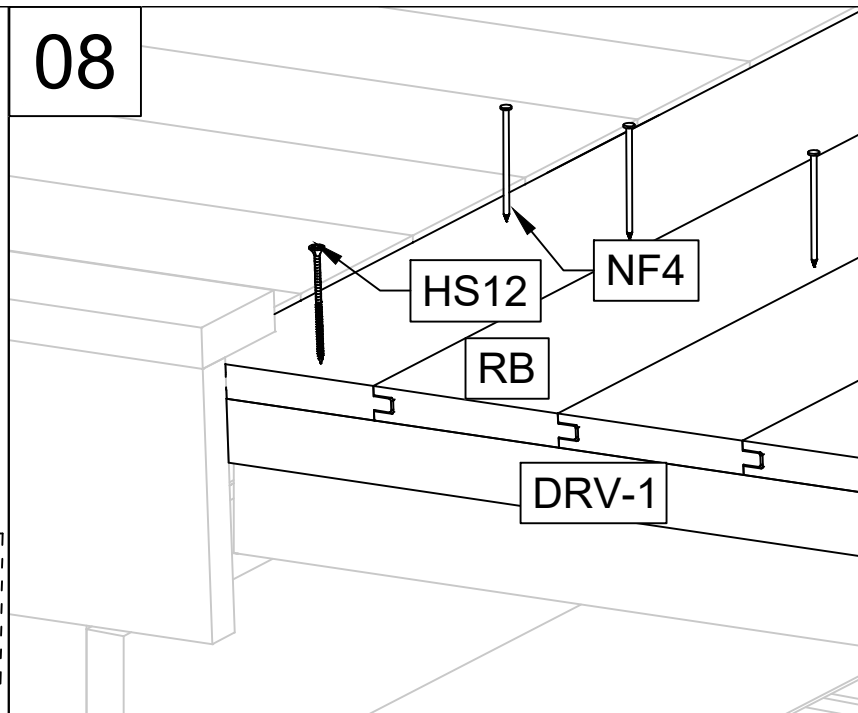

09

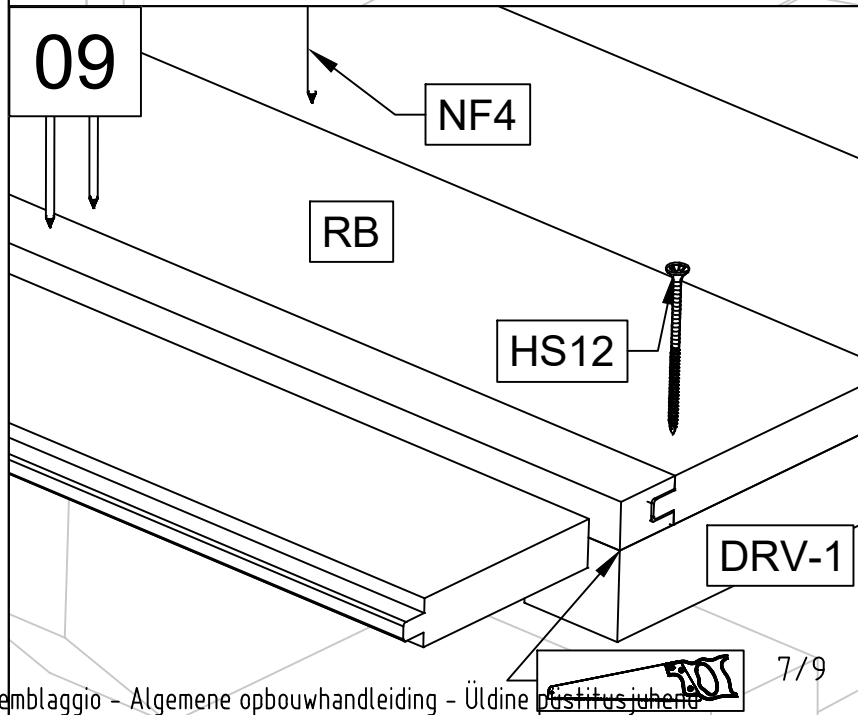

Art. Nr. 9909300

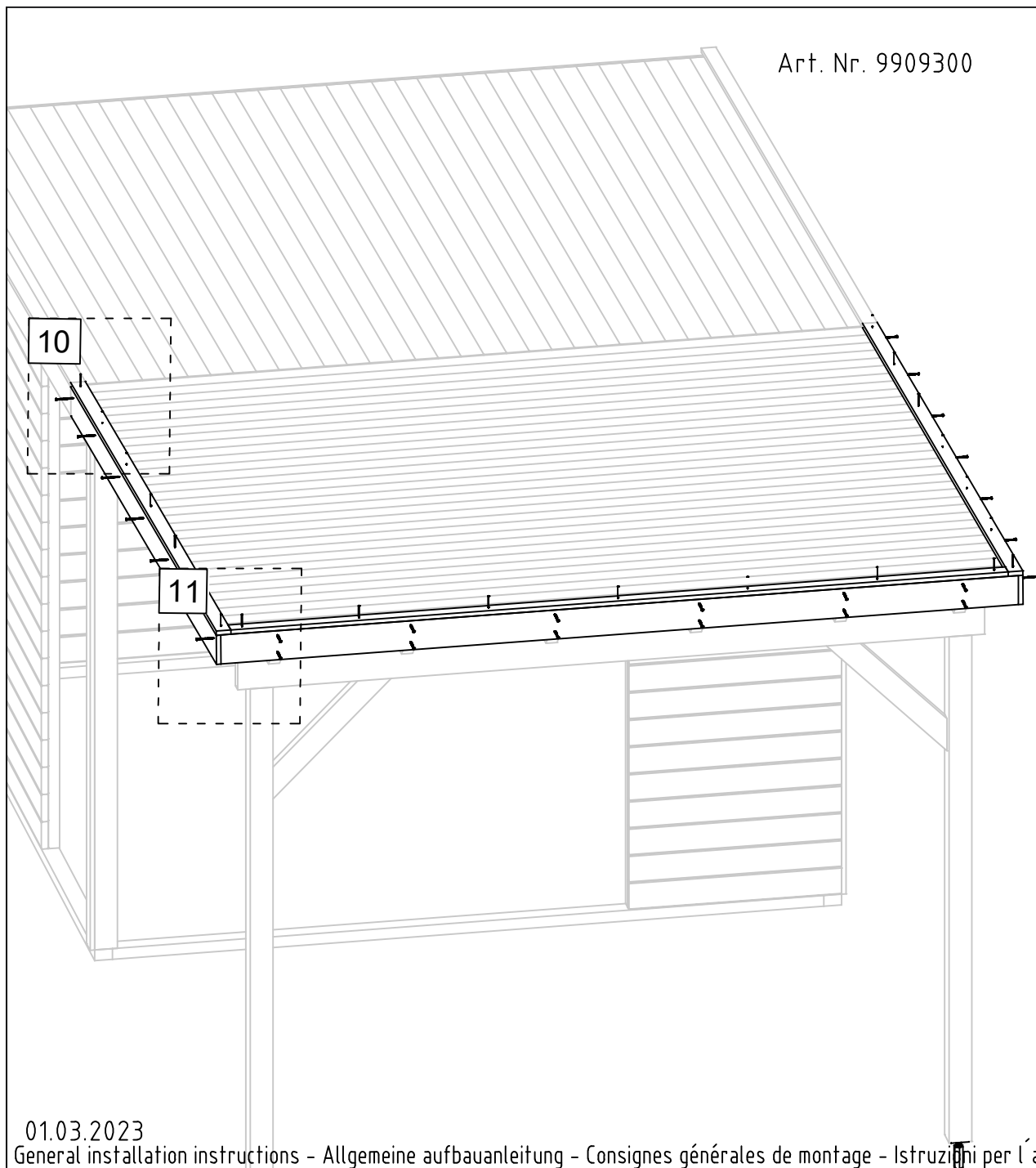

10

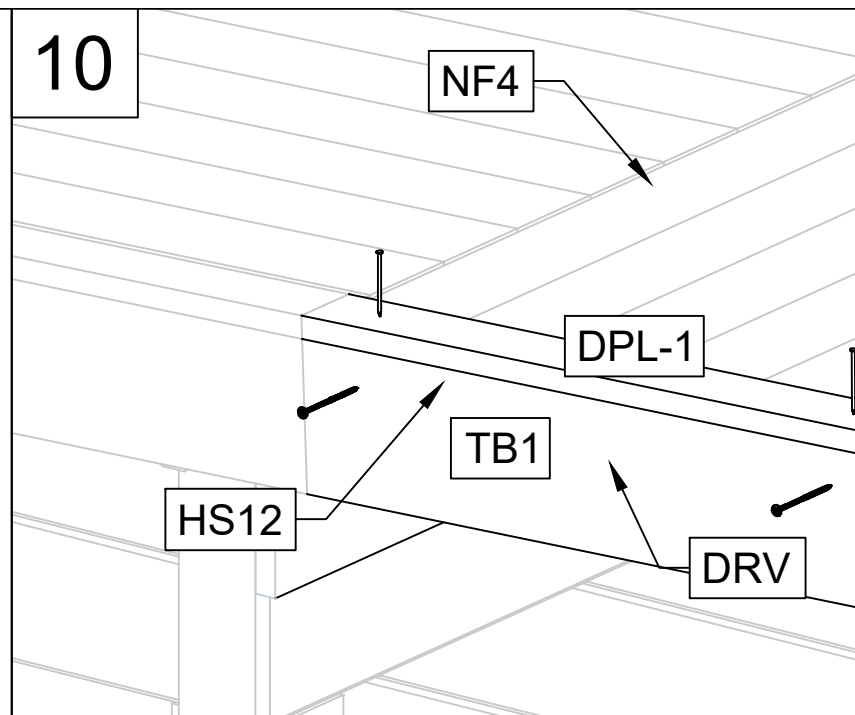

11

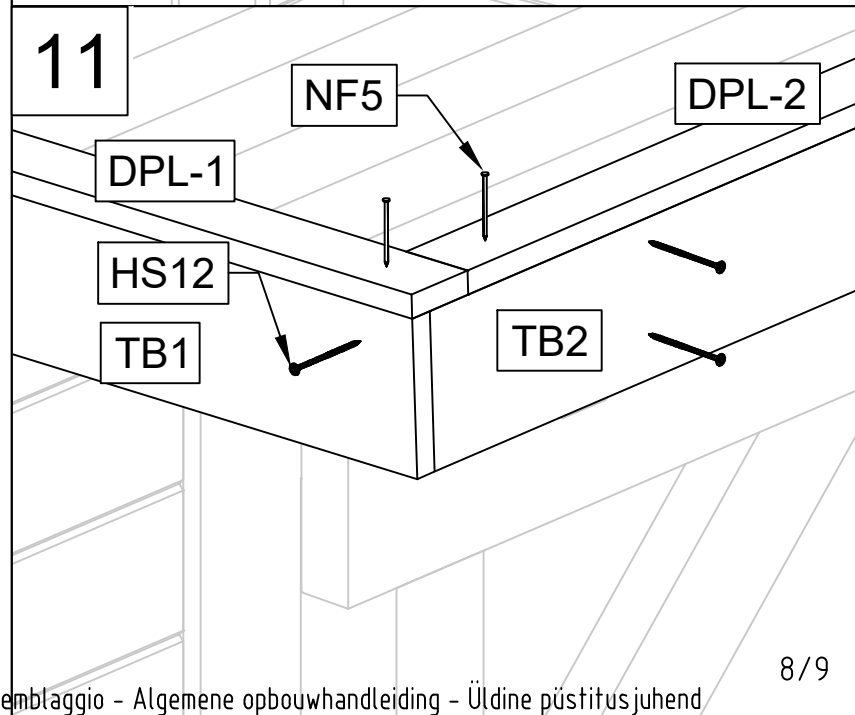

Art. Nr. 9909300

